

# Mining Methods

in Underground Mining



Third edition 2008  
[www.atlascopco.com](http://www.atlascopco.com)

*Atlas Copco*

# This is optimised productivity



Good rock-drilling economy requires highly productive rock drills. Atlas Copco's superb COP 2238 paves the way for a whole new cost scenario. World-leading technology, a unique dual-damping system and 22 kW high-impact power ensures performance and economy in a class of its own. We call this optimised productivity.

**Committed to your superior productivity.**

**Atlas Copco Rock Drills AB**

**[www.atlascopco.com](http://www.atlascopco.com)**

**Atlas Copco**

# Contents

## Foreword

- 2 Foreword by Lars Bergkvist,  
Senior Adviser – Mining  
Atlas Copco Rock Drills AB

## Talking Technically

- 3 Trends in underground mining  
7 Geology for underground mining  
13 Mineral prospecting and exploration  
17 Finding the right balance in exploration drilling  
21 Underground mining infrastructure  
25 Rapid development in mining  
28 Principles of raiseboring  
31 Mechanized bolting and screening  
35 Mining in steep orebodies  
40 Mining in flat orebodies  
43 Backfilling for safety and profit  
46 Atlas Copco rock bolts for mining

## Case Studies

- 47 Improving output at Garpenberg  
53 Changing systems at Zinkgruvan  
59 Increasing outputs at LKAB iron ore mines  
63 Production control at Kemi chrome mine  
69 Mining magnesite at Jelšava



*Front cover:  
Headframe at Australia's  
Golden Grove mine.*

- 73 All change for Asikoy copper mine  
77 Restoring profitability at Tara  
83 Mining challenge at El Soldado  
88 Pioneering mass caving at El Teniente  
95 Boxhole boring at El Teniente  
101 Modernization at Sierra Miranda  
103 Mount Isa mines continues to expand  
109 High speed haulage at Stawell  
113 Sublevel stoping at Olympic Dam  
119 Improved results at Meishan iron ore mine  
123 Breathing fresh life into Otjihase  
129 Mechanized mining in low headroom at Waterval  
131 Large scale copper mining adapted to lower seams  
135 Underground mining of limestone and gypsum  
139 Sublevel caving for chromite  
143 Getting the best for Peñoles  
147 Keeping a low profile at Panasqueira

**Produced by** Atlas Copco Rock Drills AB, SE-701 91 Örebro, Sweden, tel +46 19 670 70 00, fax 019-670 73 93. **Publisher:** Ulf Linder, ulf.linder@se.atlascopco.com  
**Production Manager:** Patrik Johansson, patrik.johansson@se.atlascopco.com **Editor:** Mike Smith, mike@tunnelbuilder.com  
**Senior Adviser:** Lars Bergkvist, lars.bergkvist@se.atlascopco.com

**Contributors:** Marcus Eklind, Patrik Ericsson, Hans Fernberg, Jan Jönsson, Mathias Lewén, Gunnar Nord, Björn Samuelsson, all name.surname@se.atlascopco.com, Adriana Potts adriana.potts@ntlworld.com, Kyran Casteel kyrancasteel@aol.com, Magnus Ericsson magnus.ericsson@rmg.se. The editor gratefully acknowledges extracts from *Underground Mining Methods – engineering fundamentals and international case studies* by William A Hustrulid and Richard L Bullock, published by SME, details from [www.smenet.org](http://www.smenet.org)

Digital copies of all Atlas Copco reference editions can be ordered from the publisher, address above, or online at [www.atlascopco.com/rock](http://www.atlascopco.com/rock).  
Reproduction of individual articles only by agreement with the publisher.

**Edited by** Mike Smith, tunnelbuilder Ltd, United Kingdom. **Designed and typeset by** ahrt, Örebro, Sweden. **Printed by** Prinfo Welins Tryckeri, Sweden.

### Legal notice

© Copyright 2008, Atlas Copco Rock Drills AB, Örebro, Sweden. All product names in this publication are trademarks of Atlas Copco. Any unauthorized use or copying of the contents or any part thereof is prohibited. This applies in particular to trademarks, model denominations, part numbers and drawings. Information in this publication is provided "as is". Atlas Copco Rock Drills AB disclaims any representation or warranties of any kind including without limitation warranties of merchantability or fitness for a particular purpose, non-infringement or content. In no event will Atlas Copco Rock Drills AB be liable to any party or any damages for any use of this publication. The contents, including illustrations and photos, in this publication may describe or show equipment with optional extras. It may also contain references to products or services that are not available in your country. This publication, as well as specifications and equipment, is subject to change without notice. Consult your Atlas Copco Customer Center for specific information.

# Foreword

## Welcome to the underground world of mining

Since ancient times, development of underground mining techniques has been driven by the needs of man, starting with simple and primitive methods and advancing to today's highly productive systems by which ore is mined from great depths in enormous quantities.

We tend to forget the history of mining when we focus on production and crucial factors such as costs, investments, metal prices and the financial situation around the world. Imagine if time travelling was possible and a miner of today could switch places with a colleague in the 16th century. That would be an interesting situation.

It is believed that iron production started around 400 BC using lumps of iron ore found in swamps and waterways. In the 12<sup>th</sup> century a new method was introduced which loosened rock by heating. The rock was heated up with an open log fire and then chilled with water so that the rock cracked and could be broken out manually with sledgehammers. The method used enormous quantities of logs, which took a huge toll on the forests in the mining areas. This continued until the 17th century when gunpowder was first used to break the rock. Despite being expensive, the method was continuously improved and used until the end of the 19<sup>th</sup> century. Technical development continued until Alfred Nobel introduced nitroglycerine, dynamite and blasting gelatine. This phase of the development was not free from incidents.

Breaking the rock by blasting under better control made it possible to sink shafts and mine underground at greater depths, bringing new challenges with the hoisting of the ore, water pumping and ventilation.

With the introduction of dynamite came the need for tools to drill holes in the rock, and Atlas Copco has been part of this development since its formation in 1873. The first rock drill was made in 1905 and has been continuously improved, reaching capacities way beyond the inventor's dreams.

So, what about the mining methods? Many have been tested throughout the years, with some producing better results than others, and accidents have happened when things have gone wrong. However, a variety of safe methods have resulted which are now applied around the world.

The mining industry is flourishing at the moment because of the strong current demand for raw materials, and the future looks bright. New mines are starting up, and existing mines are looking for ways to increase production and improve efficiency. Many of these improvements can be successfully refined for use in other mines around the world, provided a cautious approach is adopted. Every mine is different, so the details of the mining method always have to be adjusted. Health and safety is extremely important, so we strive for products that are not only efficient, but also safe. Rock reinforcement is very important in order to achieve a safe working environment.

Working deep in a mine is both tough and demanding, but need not be dangerous. Automation of operations with remote control moves the operator from an exposed face to a safe place, and our current focus is in this direction.

The Swedish mining industry has a long tradition, and Atlas Copco has been at the forefront of development since mechanization started. We are now a global company, and our visits and contacts at customers' sites can help solve all sorts of problems as the industry tries to maximize productivity.

Late last century, the manager of the American Patent Agency recommended closure of their agency on the grounds that everything had already been invented. Fortunately, we have a more positive view than that, and intend to push development even further! This book reports customers' mining methods for which we have supplied equipment. The feedback will help inspire the continued development on which our mutual success depends.



### Lars Bergkvist

Senior Adviser – Mining  
Atlas Copco Rock Drills AB

[lars.bergkvist@se.atlascopco.com](mailto:lars.bergkvist@se.atlascopco.com)

# Trends in underground mining

## Boom time in mining

The mining boom continues unabated. After a difficult ending to the 20th century, with metal prices trending downwards for almost 30 years, the global mining industry recovered in the early 2000s. Some observers claim that the industry will see a long period of increasing metal prices and, although developments will continue to be cyclical, there are predictions of a "super cycle". Already it is obvious that the present boom is something extraordinary in that it has lasted longer than previous booms in the late 1970s and the early 1950s. An almost insatiable demand for metals has been created by the unprecedented economic growth in several emerging economies led by China, with India and Russia trailing not far behind. The distribution of the value of metal production at the mine stage is shown in figure 2 on page 4 page. China and Australia are competing for first place with roughly 10 percent each. Some economic theoreticians, active during the late 1980s, who claimed that economic growth could take place without metals have been proved utterly wrong.



Dynamic growth in China.

## Stable growth

Investments into new mines have increased dramatically and all indicators point to a continued high level of project activities during the next couple of years, see figure 1.

Whatever the investment activities or metal prices, the amount of metal produced every year in global mining is fairly stable and increasing slowly but steadily. Total volumes of rock and ore handled in the global mining industry amount to approximately 30,000 Mt/y. This figure includes ore and barren rock and covers metals, industrial minerals and coal. Roughly 50% are metals, coal about 45%, and industrial minerals account for the remainder.

Figure 1: Mining projects under construction. (Raw Materials Data 2007)

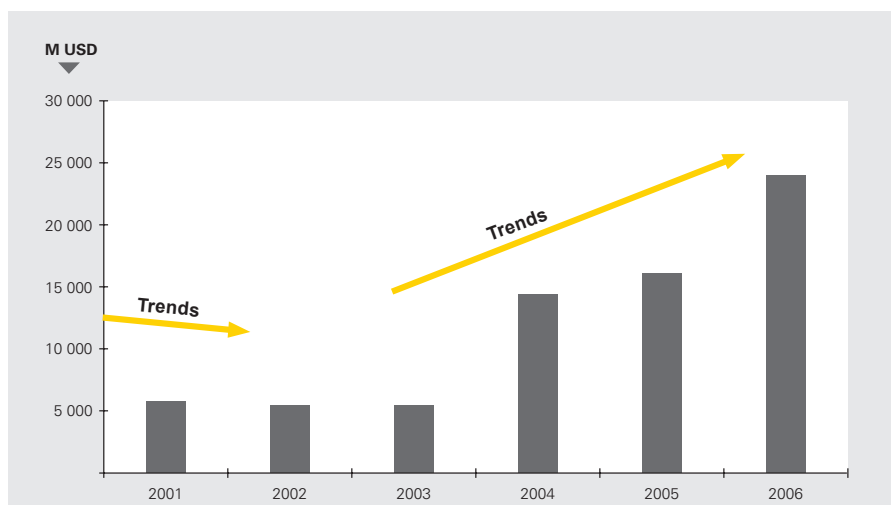

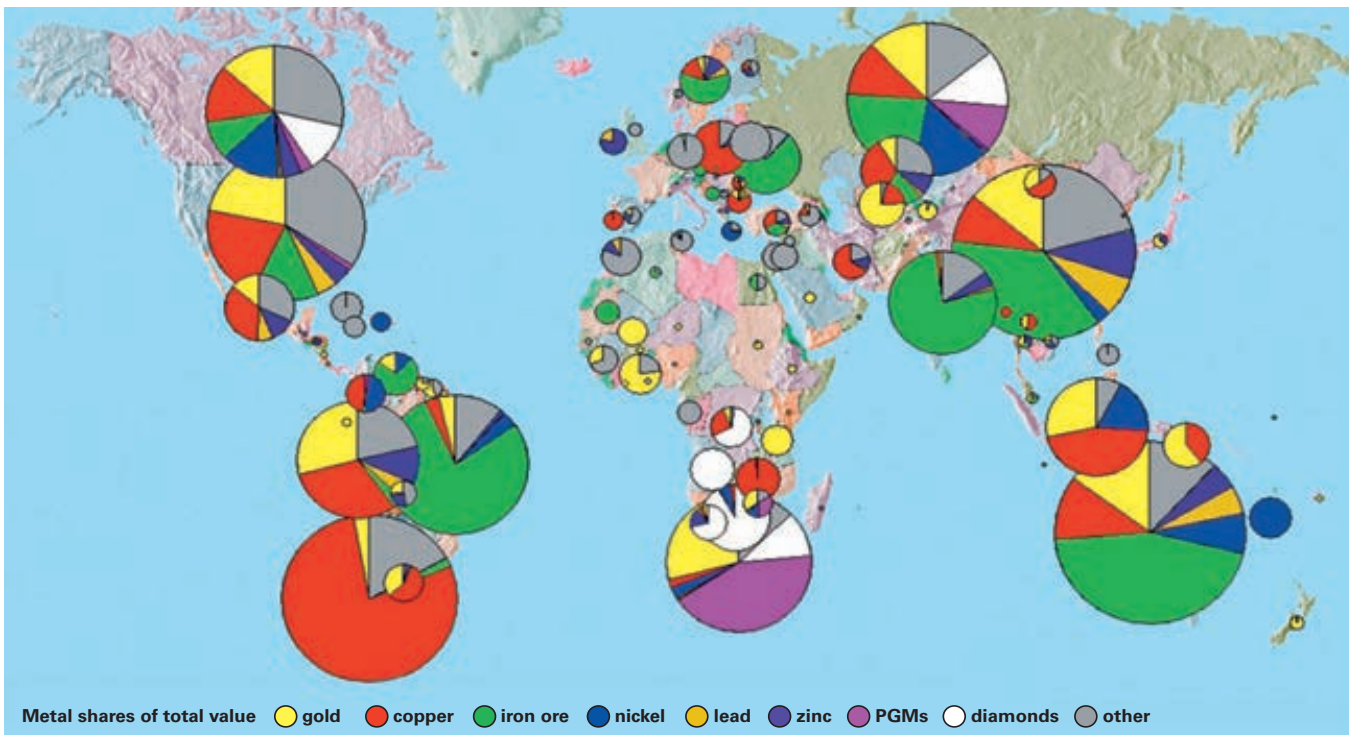

Value of metal production at mines. (Raw Materials Data 2007)

### Metal ore

Global metal ore production is around 5,000 Mt/y. Open pit mining accounts for some 83% of this, with underground methods producing the remaining 17%. Barren rock production from underground operations is small, not exceeding 10% of total ore production, but the barren rock production from open pit operations is significant.

Open pits typically have a strip ratio, the amount of overburden that has to be removed for every tonne of ore, of 2.5. Based on this assumption, the amount

of barren rock produced can be calculated as some 10,000 Mt/y. In total, the amount of rock moved in the metals mining business globally is hence around 15,000 Mt/y. The dominance of open pit operations stems in terms of the amounts of rock handled, to a large extent, from the necessary removal of overburden, which is often drilled and blasted.

By necessity, the open pit operations are larger than the underground ones. The map below shows the distribution of metal ore production around the world, and also the split between open pit and underground tonnages.

### Open pit vs underground

There was a slow trend in the late 20th century towards open pit production. Two of the most important reasons for this were as follows:

#### Lower ore grades

Due to depletion of the richer ore bodies, the higher-cost underground extraction methods are not economic. See the figure below.

#### New technologies

The more efficient exploitation of lower-grade deposits using new equipment and new processes, such as the hydrometallurgical SX-EW methods for copper extraction, has enabled companies to work with lower ore grades than with traditional methods.

### Future

Development of new mining technologies is driven by a range of underlying factors, which affect all stakeholders. Mines are getting deeper and hotter, and are now more often located in harsh environments.

Legislation, particularly concerning emissions, and increased demands on

Metal ore production from open pits (green), underground (red). (Raw Materials Data 2005)

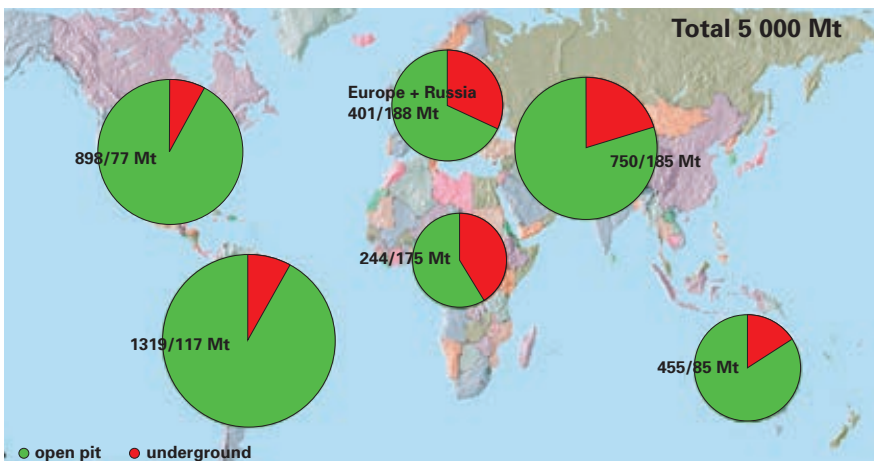

### Rock production (2005)

	Ore (Mt)	Waste (Mt)	Total (Mt)	%
<b>Metals</b>				
Underground	850	85	935	3
Open pit	4 130	10 325	14 500	47
<b>Total</b>	<b>4 980</b>	<b>10 410</b>	<b>15 400</b>	<b>50</b>
<b>Industrial minerals</b>				
Underground	65	5	70	0
Open pit	535	965	1 500	5
Total	600	970	1 570	5
<b>Sub total</b>	<b>5 600</b>	<b>11 400</b>	<b>17 000</b>	<b>55</b>
<b>Coal</b>				
Underground	2 950	575	3 500	12
Open pit	2 900	7 250	10 000	33
Total	5 850	7 825	13 500	45
<b>Overall total</b>	<b>11 450</b>	<b>19 225</b>	<b>30 700</b>	<b>100</b>

**Assumptions:** 10% waste in underground metal and industrial mineral operations. Strip ratio (overburden/ore) in open pit metal operations is 2.5. The strip ratio in industrial minerals is 1.8. For coal, underground barren rock is set at 20%, and the strip ratio in open-pit mines is 2.5. Industrial minerals includes limestone, kaolin, etc. but excludes crushed rock and other construction materials. Salt, dimensional stones, precious stones are not included. Diamonds are included in metals.

noise and vibration, affect the miners and equipment operators. Safety demands have already completely changed some unit operations, such as rock bolting and scaling. Similar developments will continue.

Customers demand higher productivity, and there is an increasing focus on machine availability and simpler service procedures in order to reduce downtime. Reduction of internal development and production costs by the equipment

manufacturer promotes new technologies, as does competition from other suppliers. In the early years of the 21st century, new efficient underground methods and equipment have made it possible to turn open pit mines that had become uneconomical because of their depth into profitable underground operations. The orebody in these mines is usually steep dipping, and can be mined with the most efficient block caving methods. The competition for land in some

densely populated countries has further meant that underground mining is the only viable alternative. Such developments have halted the growth of open pit mining and it is projected that the present ratio 1:6 underground to open pit mining will continue in the medium term.

**Magnus Ericsson**  
Raw Materials Group

Copper production vs ore grade. Source, Raw Materials Data 2007.

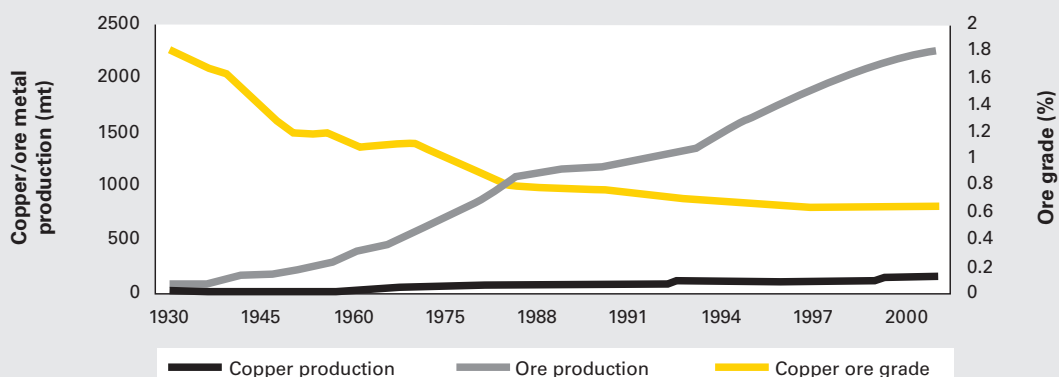



*Bingham Canyon copper mine near Salt Lake City, Utah, USA.*



# Geology for underground mining

## Importance of geology

A thorough understanding of the geology of a mineral deposit is fundamental to its successful exploitation, and this is especially important for underground working. As such, geology is a vital factor in the correct selection of mining method and equipment. Once a mining method is chosen, a major variance in the geology may make it difficult to change the approach to mining, compared to more flexible opencast work. This chapter reviews some of the important basic aspects of geology that may affect decisions about mining method. Atlas Copco offers a full range of drilling products for site investigation, and for mine development and production.

## The earth's crust

The earth's crust consists of a variety of rocks, formed under different circumstances, and with a wide variety of properties. Rocks usually consist of one or more minerals, ranging from single chemical elements to complex compounds. There are known to be more than 3,000 different minerals.

Of the 155 known elements, some of which do not occur naturally, oxygen is by far the most common, making up about 50% of the earth's crust by weight. Silicon forms about 25%, and the other common elements such as aluminium, iron, calcium, sodium, potassium, magnesium and titanium build up the total to 99% of the earth's crust.

Silicon, aluminium and oxygen occur in the commonest minerals such as quartz, feldspar and mica, which form part of a large group known as silicates, being compounds of silicic acid and other elements. Amphiboles and pyroxenes contain aluminium, potassium and iron. Some of the earth's commonest rocks, granite and gneiss, are composed of silicates.

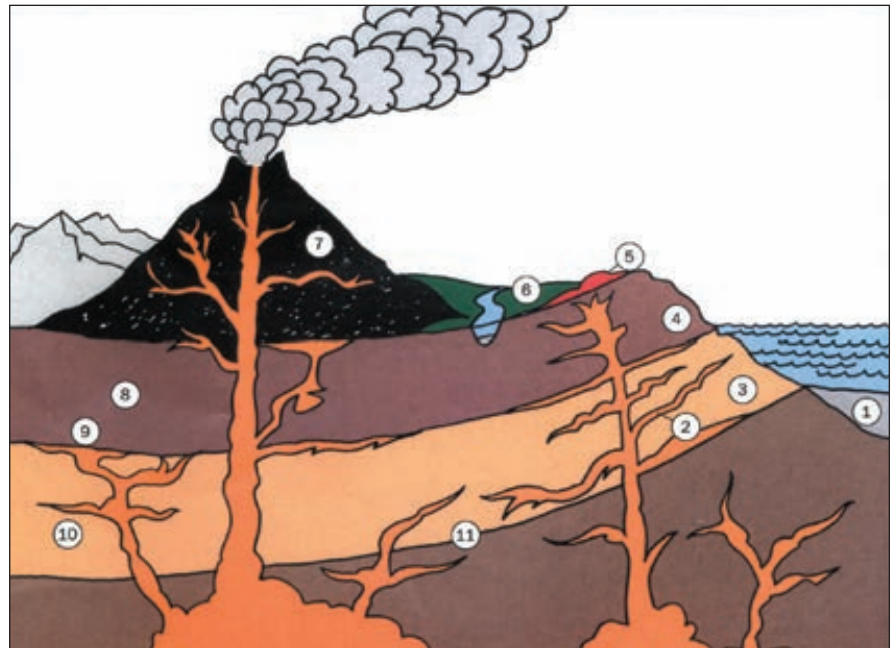

1. Recent alluvium, lake and sea-bed deposits e.g. mud, sands, calcite.
2. Orebodies, e.g. containing galena, sphalerite, chalcocopyrite and pyrite.
3. Weathered shale, perhaps forming bauxite.
4. Weathered sandstone, perhaps having high quartz content.
5. Weathered orebodies producing azurite, malachite, cuprite, etc.
6. River valley deposits may include gold, platinum, diamonds, cassiterite or magnetite, as well as clays and sands.
7. Volcanic rocks – fine-grained minerals including feldspar, quartz, olivine, hornblende, magnetite and mica.
8. Metamorphic sandstone – high proportion of quartz.
9. Metamorphic limestone as marble, etc – calcite and dolomite.
10. Metamorphic shales as slates, schists, etc. – with garnet, mica, feldspar.
11. Contact zones between igneous and 'country' rocks – garnet, hornblende, sulphides.

Oxygen also occurs commonly in combination with metallic elements, which are often important sources for mining purposes. These compounds can form part of oxidic ores, such as the iron ores magnetite and hematite.

Sulphur also readily combines with metallic elements to form sulphide ores, including galena, sphalerite, molybdenite and arsenopyrite.

Other large mineral groups important in mining include halogenides such as fluorite and halite, carbonates such as calcite, dolomite and malachite, sulphates such as barite, tungstates such as scheelite, and phosphates such as apatite.

Rarely, some elements can occur naturally without combination. The important ones are the metals gold, silver and copper, plus carbon as diamonds and graphite.

## Minerals

In some circumstances, the properties of individual minerals can be important to the means of mining, and will certainly be important for the means of extraction of the materials to be exploited. More often, however, minerals will be mixed with others to form the various types of rocks, and the properties will be combined to form both homogenous and heterogeneous structures. Feldspar accounts for almost 50% of the mineral composition of the earth's crust. Next come the pyroxene and amphibole minerals, closely followed by quartz and mica. These minerals all make up about 90% of the composition of the earth's crust.

Minerals have a wide variety of properties that can be important in their usefulness to man, and to the best way

to mine or tunnel through them, or both. Some of these important characteristics, which are also important for correct mineral identification in the field before chemical analysis, are hardness, density, colour, streak, lustre, fracture, cleavage and crystalline form.

The particle size, and the extent to which the mineral is hydrated or otherwise mixed with water, can be very important to the behaviour of the rock structure when excavated. Mineral hardness is commonly graded according to the Moh 10-point scale

The density of light-coloured minerals is usually below 3. Exceptions are barite or heavy spar (barium sulphate –  $\text{BaSO}_4$  – density 4.5), scheelite (calcium tungstate –  $\text{CaWO}_4$  – density 6.0) and cerussite (lead carbonate –  $\text{PbCO}_3$  – density 6.5). Dark coloured minerals with some iron and silicate have densities between 3 and 4. Metallic ore

mineral, but not following a crystallographically defined plane. Fracture is usually uneven in one direction or another.

Cleavage denotes the properties of a crystal whereby it allows itself to be split along flat surfaces parallel with certain formed, or otherwise crystallographically defined, surfaces. Both fracture and cleavage can be important to the structure of rocks containing substantial amounts of the minerals concerned.

## Properties

Rocks, normally comprising a mixture of minerals, not only combine the properties of these minerals, but also exhibit properties resulting from the way in which the rocks have been formed, or perhaps subsequently altered by heat, pressure and other forces in the earth's

Moh's hardness scale	Typical mineral	Identification of hardness
1	Talc	Easily scratched with a fingernail
2	Gypsum	Barely scratched with a fingernail
3	Calcite	Very easily scratched with a knife
4	Fluorite	Easily scratched with a knife
5	Apatite	Can be scratched with a knife
6	Orthoclase	Difficult to scratch with a knife, but can be scratched with quartz
7	Quartz	Scratches glass and can be scratched with a hardened steel file
8	Topaz	Scratches glass and can be scratched with emery board/paper (carbide)
9	Corundum	Scratches glass. Can be scratched with a diamond
10	Diamond	Scratches glass and can only be marked by itself

minerals have densities over 4 Gold has a very high density of 19.3. Minerals with tungsten, osmium and iridium are normally even denser.

Streak is the colour of the mineral powder produced when a mineral is scratched or rubbed against unglazed white porcelain, and may be different from the colour of the mineral mass. Fracture is the surface characteristic produced by breaking of a piece of the

crust. It is comparatively rare to find rocks forming a homogeneous mass, and they can exhibit hard-to-predict discontinuities such as faults, perhaps filled with crushed material, and major jointing and bedding unconformities. These discontinuities can be important in mining, not only for the structural security of the mine and gaining access to mineral deposits, but also as paths for fluids in the earth's crust which

## Samples of common rock types

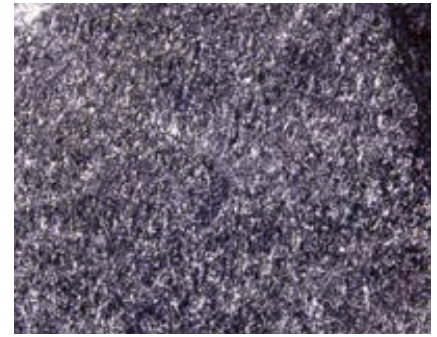

*Amphibolite.*

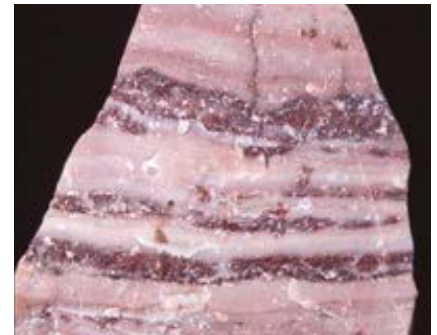

*Dolomitic limestone.*

cause mineral concentrations. In order for mining to be economic, the required minerals have to be present in sufficient concentration to be worth extracting, and within rock structures that can be excavated safely and economically. As regards mine development and production employing drilling, there must be a correct appraisal of the rock concerned. This will affect forecast drill penetration rate, hole quality, and drill steel costs, as examples.

One must distinguish between microscopic and macroscopic properties, to determine overall rock characteristics. As a rock is composed of grains of various minerals, the microscopic properties include mineral composition, grain size, the form and distribution of the grain, and whether the grains are loose or cemented together. Collectively, these factors develop important properties of the rock, such as hardness, abrasiveness, compressive strength and density. In turn, these rock properties determine the penetration rate that can be achieved, and how heavy the tool wear will be.

In some circumstances, certain mineral characteristics will be particularly important to the means of excavation.



Sandstone.

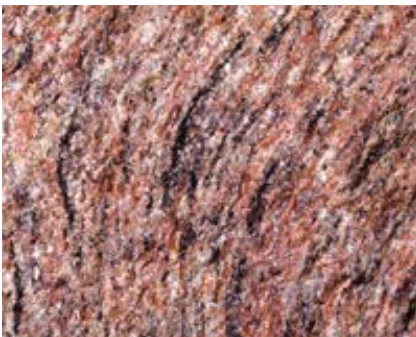

Gneiss.

Many salts, for example, are particularly elastic, and can absorb the shocks of blasting without a second free face being cut, thereby directly influencing mining method.

The drillability of a rock depends on, among other things, the hardness of its constituent minerals, and on the grain size and crystal form, if any.

Quartz is one of the commonest minerals in rocks. Since quartz is a very hard material, high quartz content in rock can make it very hard to drill, and will certainly cause heavy wear, particularly on drill bits. This is known as abrasion. Conversely, a rock with a high content of calcite can be comparatively easy to drill, and cause little wear on drill bits. As regards crystal form, minerals with high symmetry, such as cubic galena, are easier to drill than minerals with low symmetry, such as amphiboles and pyroxenes.

A coarse-grained structure is easier to drill, and causes less wear of the drill string than a fine-grained structure. Consequently, rocks with essentially the same mineral content may be very different in terms of drillability. For example, quartzite can be fine-grained

(0.5-1.0 mm) or dense (grain size 0.05 mm). A granite may be coarse-grained (size >5 mm), medium-grained (1-5 mm) or fine-grained (0.5-1.0 mm).

A rock can also be classified in terms of its structure. If the mineral grains are mixed in a homogeneous mass, the rock is termed massive, as with most granite. In mixed rocks, the grains tend to be segregated in layers, whether due to sedimentary formation or metamorphic action from heat and/or pressure. Thus, the origin of a rock is also important, although rocks of different origin may have similar structural properties such as layering. The three classes of rock origin are:

**Igneous or magmatic:** formed from solidified lava at or near the surface, or magma underground.

**Sedimentary:** formed by the deposition of reduced material from other rocks and organic remains, or by chemical precipitation from salts, or similar.

**Metamorphic:** formed by the transformation of igneous or sedimentary rocks, in most cases by an increase in pressure and heat.

## Igneous rocks

Igneous rocks are formed when magma solidifies, whether plutonic rock, deep in the earth's crust as it rises to the surface in dykes cutting across other rock or sills following bedding planes, or volcanic, as lava or ash on the surface. The most important mineral constituents are quartz and silicates of various types, but mainly feldspars. Plutonic rocks solidify slowly, and are therefore coarse-grained, whilst volcanic rocks solidify comparatively quickly and

become fine-grained, sometimes even forming glass.

Depending on where the magma solidifies, the rock is given different names, even if its chemical composition is the same, as shown in the table of main igneous rock types. A further subdivision of rock types depends on the silica content, with rocks of high silica content being termed acidic, and those with lower amounts of silica termed basic. The proportion of silica content can determine the behaviour of the magma and lava, and hence the structures it can produce.

## Sedimentary rocks

Sedimentary rocks are formed by the deposition of material, by mechanical or chemical action, and its consolidation under the pressure of overburden. This generally increases the hardness of the rock with age, depending on its mineral composition. Most commonly, sedimentary rocks are formed by mechanical action such as weathering or abrasion on a rock mass, its transportation by a medium such as flowing water or air, and subsequent deposition, usually in still water. Thus, the original rock will partially determine the characteristics of the sedimentary rock. Weathering or erosion may proceed at different rates, as will the transportation, affected by the climate at the time and the nature of the original rock. These will also affect the nature of the rock eventually formed, as will the conditions of deposition. Special cases of sedimentary rock include those formed by chemical deposition, such as salts and limestones, and organic material such as coral and shell

**Table of main igneous rock types**

Silica (SiO <sub>2</sub> ) content	Plutonic rocks	Dykes and Sills	Volcanic (mainly lava)
Basic – <52% SiO <sub>2</sub>	Gabbro	Diabase	Basalt
Intermediate – 52-65% SiO <sub>2</sub>	Diorite Syenite	Porphyrite Syenite	Andesite Trachyte porphyry
Acidic – >65% SiO <sub>2</sub>	Quartz diorite Granodiorite Granite	Quartz porphyrite Granodiorite porphyry Quartz porphyry	Dacite Rhyodacite Rhyolite

### Some sedimentary rock types

Rock	Original material
Conglomerate	Gravel, stones and boulders, generally with limestone or quartzitic cement
Greywacke	Clay and gravel
Sandstone	Sand
Clay	Fine-grained argillaceous material and precipitated aluminates
Limestone	Precipitated calcium carbonate, corals, shellfish
Coals	Vegetation in swamp conditions
Rock salt, potash, gypsum, etc	Chemicals in solution precipitated out by heat
Loess	Wind-blown clay and sand

limestones and coals, while others will be a combination, such as tar sands and oil shales.

Another set of special cases is glacial deposits, in which deposition is generally haphazard, depending on ice movements.

Several distinct layers can often be observed in a sedimentary formation, although these may be uneven, according to the conditions of deposition. The layers can be tilted and folded by subsequent ground movements. Sedimentary rocks make up a very heterogeneous family, with widely varying characteristics, as shown in the table of sedimentary rock types.

## Metamorphic rocks

The effects of chemical action, increased pressure due to ground movement, and/or temperature of a rock formation can sometimes be sufficiently great to cause a transformation in the internal structure and/or mineral composition of the original rock. This is called metamorphism. For example, pressure and temperature may increase under the influence of up-welling magma, or because the strata have sunk deeper into the earth's crust. This will result in the recrystallization of the minerals, or the formation of new minerals. A characteristic of metamorphic rocks is that they are formed without complete remelting, or else they would be termed igneous. The metamorphic action often makes the rocks harder and denser, and more difficult to drill. However, many metamorphic zones, particularly formed in the contact zones adjacent to igneous

intrusions, are important sources of valuable minerals, such as those concentrated by deposition from hydrothermal solutions in veins.

As metamorphism is a secondary process, it may not be clear whether a sedimentary rock has, for example, become metamorphic, depending on the degree of extra pressure and temperature to which it has been subjected. The mineral composition and structure would probably give the best clue.

Due to the nature of their formation, metamorphic zones will probably be associated with increased faulting and structural disorder, making the planning of mine development, and efficient drilling, more difficult.

## Rock structures and mining method

Macroscopic rock properties include slatiness, fissuring, contact zones, layering, veining and inclination. These factors are often of great significance in

drilling. For example, cracks or inclined and layered formations can cause hole deviation, particularly in long holes, and have a tendency to cause drilling tools to get stuck, although modern drilling control methods can greatly reduce this problem. Soft or crumbly rocks make it difficult to achieve good hole quality, since the walls can cave in. In extreme cases, flushing air or fluid will disappear into cracks in the rock, without removing cuttings from the hole. In some rocks there may be substantial cavities, such as with solution passages in limestones, or gas bubbles in igneous rock. These may necessitate prior grouting to achieve reasonable drilling properties.

On a larger scale, the rock structure may determine the mining method, based on factors such as the shape of the mineral deposit, and qualities such as friability, blockiness, in-situ stress, and plasticity. The shape of the mineral deposit will decide how it should be developed, as shown in the chapters on mining flat and steep orebodies later in this issue. The remaining rock qualities can all be major factors in determining the feasibility of exploiting a mineral deposit, mainly because of their effect on the degree of support required, for both production level drives and for development tunnels.

## Mineral deposit exploration

There will be a delicate economic balance between an investment in development drives in stable ground, perhaps without useful mineralization, and

### Typical metamorphic rocks

Rock type	Original rock	Degree of metamorphism
Amphibolite	Basalt, diabase, gabbro	High
Mica schist	Mudstone, greywacke, etc	Medium to high
Gneiss	Various igneous rocks	High
Green-schist	Basalt, diabase, gabbro	Low
Quartzite	Sandstone	Medium to high
Leptite	Dacite	Medium
Slate	Shale	Low
Veined gneiss	Silicic-acid-rich silicate rocks	High
Marble	Limestone	Low

drives within the mineral deposit, perhaps of shorter life, but requiring more support measures. Setting aside support requirements, in general terms it would seem beneficial to carry out as much of the development work as possible within the mineral deposit, making development drives in non-productive gangue rocks as short as possible. However, it may be decided that a major development asset, such as a shaft or transport level, should be in as stable a ground area that can be found, with further drives or levels made from it.

In extreme cases, it may be found that the mineral deposit cannot support development workings without considerable expense. In these circumstances, it might be better to make development drives near and below the mineral deposit, and exploit it with little direct entry, such as by longhole drilling and blasting, with the ore being drawn off from below.

Depending on the amount of disturbance that the mineral-bearing strata has been subjected to, the mineral deposit can vary in shape from stratified rock at various inclinations, to highly contorted and irregular vein formations requiring a very irregular development pattern.

The latter may require small drives to exploit valuable minerals, although the productivity of modern mining equipment makes larger section drives more economic, despite the excavation of more waste rock.

The tendency of a rock to fracture, sometimes unpredictably, is also important to determine drivage factors, such as support requirements, and the charging of peripheral holes to prevent overbreak. Although overbreak may not be so important in mining as in civil tunnelling, it can still be a safety consideration to prevent the excavation of too much gangue material, and to preserve the structure of a drive.

## Investigation and exploration

It is clear that rock structures, and the minerals they contain, can result in a wide variety of possible mining strategies. Obviously, the more information that is gained, the better should be the

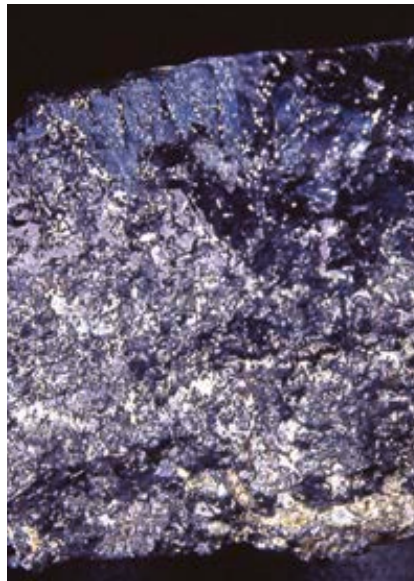

*Diabase.*



*Granite.*

chances of mining success. There are plenty of potential risks in underground mining, and it is best to minimize these.

Using modern mining equipment, there is the potential to turn the mine into a mineral factory. However, if uncertainties manifest themselves in unforeseen ground conditions, disappearing orebodies, and factors such as excessive water infiltration, then the advantage of productive mining equipment will be lost, as it is forced to stand idle.

The only way to avoid these situations is to carry out as much exploration work as possible, not only to investigate

the existence and location of worthwhile minerals, but also to check on rock qualities in and around the deposit. In underground mining, information from surface borehole and geophysical methods of investigation can be supplemented by probe or core drilling underground. The resulting vast amount of data may be too much to be assessed manually, but computer software programs are available to deduce the best strategies for mineral deposit exploitation. In addition, the mining expertise of Atlas Copco is available to help mining engineers decide, not only on the best equipment to use for investigation, development and production, but also how these can be used to maximum effect.

The value of the mineral to be mined will obviously be a determinant on how much investigation work is desirable, but there will be a minimum level for each type of mine, in order to give some assurance of success.

For example, low-value stratified deposits, which are known to be fairly uniform in thickness and have regular dips, may not necessitate many boreholes, although there could still be surprises from sedimentary washouts or faults. On the other hand, gold deposits in contorted rock formations will require frequent boreholes from underground, as well as from the surface, to give assurance of the location of the deposit and to sample the minerals it contains.

## Rock classification for drilling

Having determined the value and shape of a mineral deposit, the nature and structure of the rocks that surround it, and the likely strategy for the mine development, it should be possible to determine the suitability of various excavation methods for the rocks likely to be encountered.

It will also be necessary to determine which ancillary equipment may be required, and how best to fit this into the excavation cycle.

With drill-and-blast development drivages, for example, the rock types and structure may determine that substantial support is required. This, in

turn, may require a rockbolting facility on the drill rig, perhaps with an access basket suitable for erecting arch crowns and charging blastholes. It may be decided that an additional rockbolting rig is required, for secondary support.

In order to systematically determine the likely excavation and support requirements, the amount of consumables required, and whether a particular method is suitable, a number of rock classification systems have been developed. These are generally oriented to a particular purpose, such as the level of support required or the rock's drillability.

The methods developed to assess drillability are aimed at predicting productivity and tool wear. Factors of drillability include the likely tool penetration rate commensurate with tool wear, the stand-up qualities of the hole, its straightness, and any tendency to tool jamming. Tool wear is often proportional to drillability, although the rock's abrasiveness is important.

Rock drillability is determined by several factors, led by mineral composition, grain size and brittleness. In crude terms, rock compressive strength or hardness can be related to drillability for rough calculations, but the matter is usually more complicated.

The Norwegian Technical University has determined more sophisticated methods: the Drilling Rate Index (DRI) and the Bit Wear Index (BWI).

The DRI describes how fast a particular drill steel can penetrate. It also includes measurements of brittleness and drilling with a small, standard rotating bit into a sample of the rock. The higher the DRI, the higher the penetration rate, and this can vary greatly from one rock type to another, as shown in the bar chart.

It should be noted that modern drill bits greatly improve the possible penetration rates in the same rock types. Also, there are different types of bits available to suit certain types of rock. For example, Secoroc special bits for soft formations, bits with larger gauge buttons for abrasive formations, and guide bits or retrac bits for formations where hole deviation is a problem.

The BWI gives an indication of how fast the bit wears down, as deter-

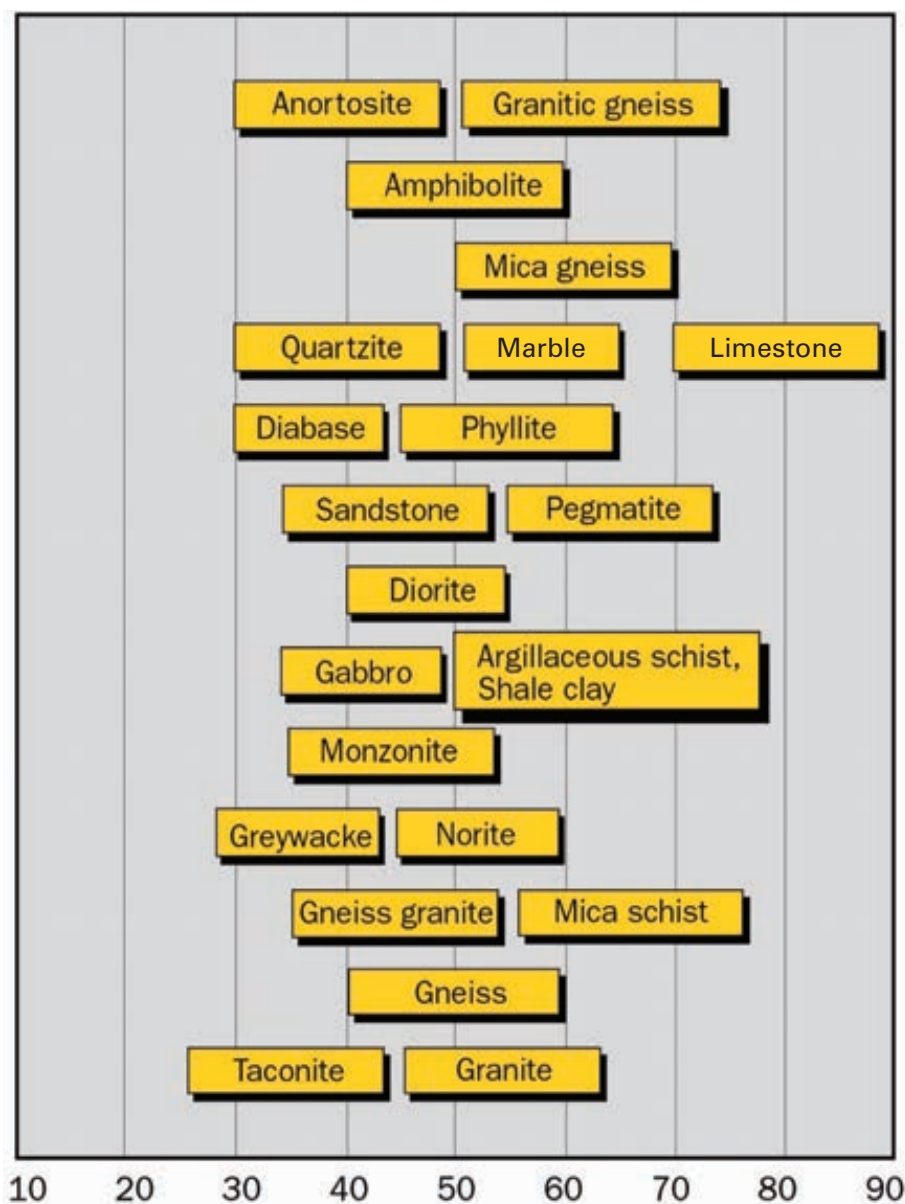

Relationship between drilling rate index and various rock types.

mined by an abrasion test. The higher the BWI, the faster will be the wear. In most cases, the DWI and BWI are inversely proportional to one another.

However, the presence of hard minerals may produce heavy wear on the bit, despite relatively good drillability. This is particularly the case with quartz, which has been shown to increase wear rates greatly. Certain sulphides in ore-bodies are also comparatively hard, impairing drillability.

Other means of commonly used rock classification include the Q-system (Barton et al, through the Norwegian Geotechnical Institute), Rock Mass Rating RMR (Bieniawski), and the

Geological Strength Index GSI (Hoek et al). Bieniawski's RMR incorporates the earlier Rock Quality Designation (RQD – Deere et al), with some important improvements taking into account additional rock properties.

All give valuable guidance on the rock's ease of excavation, and its self-supporting properties. In most cases, engineers will employ more than one means of rock classification to give a better understanding of its behaviour, and to compare results.

**Björn Samuelsson**

# Mineral prospecting and exploration

## Finding orebodies

For a geologist in the mining business, exploiting an orebody is the easy part of the job. The hardest part is to find the orebody and define it. But how do you find these accumulations of metallic minerals in the earth's crust? The mining company has to ensure that an orebody is economically viable, and needs a guarantee of ore production over a very long period of time, before it will engage in the heavy investment required to set up a mining operation. Even after production starts, it is necessary to locate and delineate any extensions to the mineralization, and to look for new prospects that may replace the reserves being mined. Investigating extensions, and searching for new orebodies, are vital activities for the mining company.

## Prospecting

Prospecting involves searching a district for minerals with a view to further operation. Exploration, while it sounds similar to prospecting, is the term used for systematic examination of a deposit. It is not easy to define the point where prospecting turns into exploration.

A geologist prospecting a district is looking for surface exposure of minerals, by observing irregularities in colour, shape or rock composition. He uses a hammer, a magnifying glass and some other simple instruments to examine whatever seems to be of interest. His experience tells him where to look, to have the greatest chances of success. Sometimes he will stumble across ancient, shallow mine workings, which may be what led him to prospect that particular area in the first place.

Soil-covered ground is inaccessible to the prospector, whose first check would be to look for an outcrop of the mineralization. Where the ground cover comprises a shallow layer of alluviums,



*Gold panning in the wind.*

trenches can be dug across the mineralized area to expose the bedrock. A prospector will identify the discovery, measure both width and length, and calculate the mineralized area. Rock samples from trenches are sent to the laboratory for analysis. Even when minerals show on surface, determining any extension in depth is a matter of qualified guesswork. If the prospector's findings, and his theorizing about the probable existence of an orebody are solid, the next step would be to explore

the surrounding ground. Exploration is a term embracing geophysics, geochemistry, and also drilling into the ground for obtaining samples from any depth.

## Geophysical exploration

From surface, different geophysical methods are used to explore subsurface formations, based on the physical properties of rock and metal bearing minerals such as magnetism, gravity, electrical

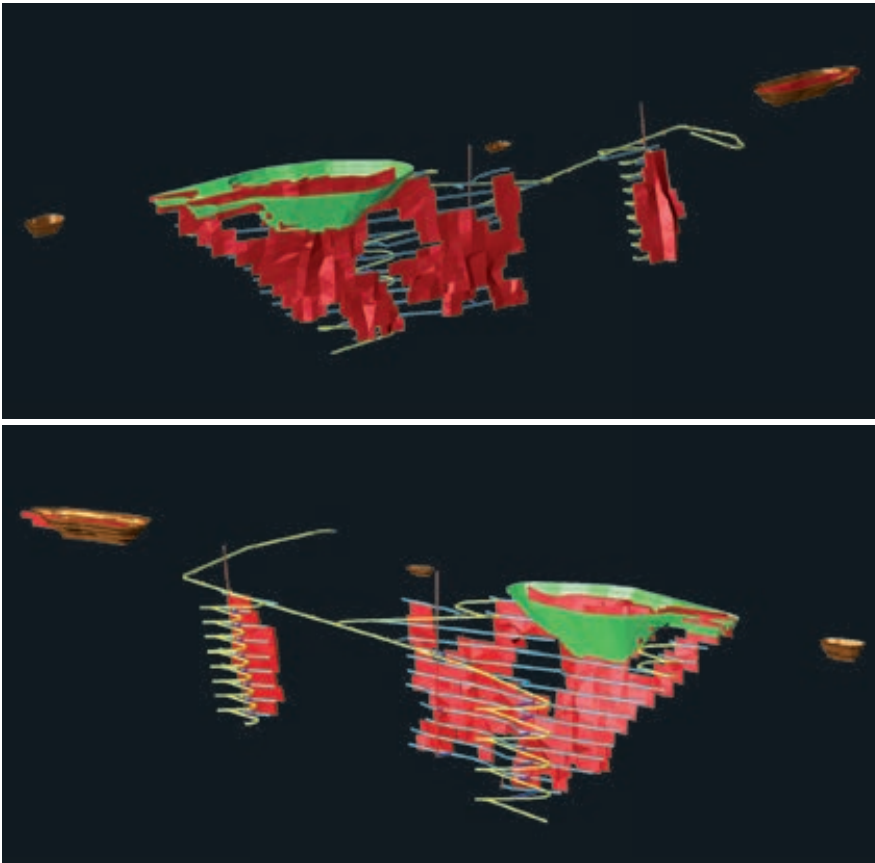

Two computer generated views of Agnico Eagle's Suurikuusiko gold mining project showing both surface and underground mining.

conductivity, radioactivity, and sound velocity. Two or more geophysical methods are often combined in one survey, to acquire more reliable data. Results from the surveys are compiled, and matched with geological information from surface and records from any core drilling, to decide if it is worth proceeding with further exploration.

## Surveys

Magnetic surveys measure variations in the Earth's magnetic field caused by magnetic properties of subsurface rock formations. In prospecting for metallic minerals, these techniques are particularly useful for locating magnetite, pyrrhotite and ilmenite. Electromagnetic surveys are based on variations of electric conductivity in the rock mass. An electric conductor is used to create a primary alternating electromagnetic field. Induced currents produce a secondary field in the rock mass. The resultant field can be traced and measured, thus revealing the conductivity

of the underground masses. Electromagnetic surveys are mainly used to map geological structures, and to discover mineral deposits such as sulphides containing copper or lead, magnetite, pyrite, graphite, and certain manganese minerals.

Electric surveys measure either the natural flow of electricity in the ground, or "galvanic" currents led into the ground and accurately controlled. Electrical surveys are used to locate mineral deposits at shallow depth and map geological structures to determine the depth of overburden to bedrock, or to locate the groundwater table.

Gravimetric surveys measure small variations in the gravitational field caused by the pull of underlying rock masses. The variation in gravity may be caused by faults, anticlines, and salt domes that are often associated with oil-bearing formations.

Gravimetric surveys are also used to detect high-density minerals, like iron ore, pyrites and lead-zinc mineralizations.

In regions where rock formations contain radioactive minerals, the intensity of radiation will be considerably higher than the normal background level. Measuring radiation levels helps locate deposits containing uranium, thorium and other minerals associated with radioactive substances.

The seismic survey is based on variations of sound velocity experienced in different geological strata. The time is measured for sound to travel from a source on surface, through the underlying layers, and up again to one or more detectors placed at some distance on surface. The source of sound might be the blow of a sledgehammer, a heavy falling weight, a mechanical vibrator, or an explosive charge. Seismic surveys determine the quality of bedrock, and can locate the contact surface of geological layers, or of a compact mineral deposit deep in the ground. Seismic surveys are also used to locate oil-bearing strata.

Geochemical surveying is another exploration technology featuring several

*Is there gold in the trench?*

*International Gold Exploration AB, IGE conducts exploration works in Kenya.*







Atlas Copco underground core drilling rig Diamec U4.

specialities, the main one being to detect the presence of metals in the top-soil cover. By taking a large number of samples over an extended area and analyzing the minute contents of each metal, regions of interest are identified. The area is then selected for more detailed studies.

## Exploratory drilling

For a driller, all other exploration methods are like beating about the bush. Drilling penetrates deep into the ground, and brings up samples of whatever it finds on its way. If there is any mineralization at given points far beneath the surface, drilling can give a straightforward answer, and can quantify its presence at that particular point.

There are two main methods of exploratory drilling. The most common, core drilling, yields a solid cylinder shaped sample of the ground at an exact depth. Percussion drilling yields a crushed sample, comprising cuttings from a fairly well-determined depth

in the hole. Beyond that, the drillhole itself can provide a complementary amount of information, particularly by logging using devices to detect physical anomalies, similar to the geophysical surveys mentioned above.

Core drilling is also used to define the size and the exact borders of mineralization during the lifetime of the mine. This is important for determining ore grades being handled, and vital for calculating the mineral reserves that will keep the mine running in the future. A strategically-placed underground core drill may also probe for new ore bodies in the neighbourhood.

## Core drilling

In 1863, the Swiss engineer M Lescot designed a tube with a diamond set face, for drilling in the Mount Cenis tunnel, where the rock was too hard for conventional tools. The intention was to explore rock quality ahead of the tunnel face, and warn miners of possible rock falls.

This was the accidental birth of core drilling, a technique now very widely used within the mining industry. Core drilling is carried out with special drill rigs, using a hollow drill string with an impregnated diamond cutting bit to resist wear while drilling hard rock. The crown-shaped diamond bit cuts a cylindrical core of the rock, which is caught and retained in a double tube core-barrel.

A core-catcher is embedded in, or just above, the diamond bit, to make sure that the core does not fall out of the tube. In order to retrieve the core, the core-barrel is taken to surface, either by pulling up the complete drill string or, if the appropriate equipment is being used, by pulling up only the inner tube of the core-barrel with a special fishing device run inside the drill string at the end of a thin steel wire.

The core is an intact sample of the underground geology, which can be examined thoroughly by the geologist to determine the exact nature of the rock and any mineralization. Samples of

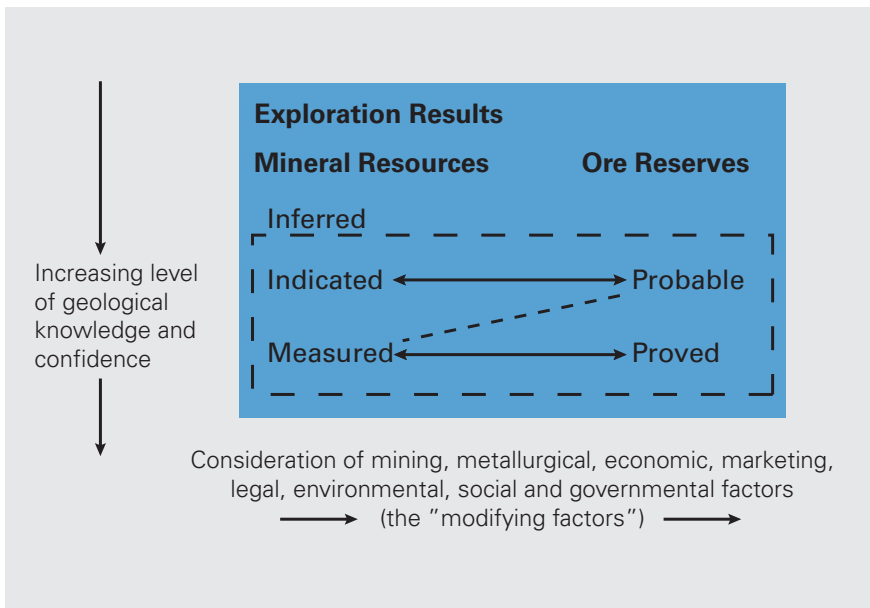

*The 2004 Australasian code for reporting exploration results, mineral resources and ore reserves.*

special interest are sent to a laboratory for analysis to reveal any metal contents. Cores from exploration drilling are stored in special boxes and kept in archives for a long period of time. Boxes are marked to identify from which hole, and at what depth, the sample was taken. The information gathered by core drilling is important, and represents substantial capital investment.

Traditionally, core drilling was a very arduous job, and developing new techniques and more operator-friendly equipment was very slow, and the cost per drilled metre was often prohibitive. Atlas Copco Geotechnical Drilling and Exploration pioneered several techniques to reduce manual work, increase efficiency and cut the cost per drilled metre.

Over the years, the company developed thin walled core barrels, diamond impregnated bits, aluminium drill rods, fast rotating hydraulic rigs, mechanical rod handling, and, more recently, partly or totally computer-controlled rigs. Core drilling has always been the most powerful tool in mineral exploration. Now that it has become much cheaper, faster and easier, it is being used more widely.

## Reverse circulation drilling

To obtain information from large orebodies where minerals are not concentrated in narrow veins, reverse circulation

drilling is used. Reverse circulation drilling is a fast, but inaccurate, exploration method, which uses near-standard percussion drilling equipment. The flushing media is introduced at the hole collar in the annular space of a double-tubed drill string, and pushed down to the bottom of the hole to flush the cuttings up through the inner tube. The drill cuttings discharged on surface are sampled to identify variations in the mineralization of the rock mass. Reverse circulation drilling uses much heavier equipment than core drilling, and has thus a limited scope in depth.

## From prospecting to mining

Every orebody has its own story, but there is often a sequence of findings. After a certain area catches the interest of the geologists, because of ancient mine works, mineral outcrops or geological similarities, a decision is taken to prospect the area. If prospecting confirms the initial interest, some geophysical work might be carried out. If interest still persists, the next step would be to core drill a few holes to find out if there is any mineralization.

To quantify the mineralization, and to define the shape and size of the ore body, then entails large investment to drill exploratory holes in the required patterns.

At every step of the procedure, the geologists examine the information at hand, to recommend continuing the exploration effort. The objective is to be fairly certain that the orebody is economically viable by providing a detailed knowledge of the geology for a clear financial picture. Ore is an economic concept, defined as a concentration of minerals, which can be economically exploited and turned into a saleable product.

Before a mineral prospect can be labelled as an orebody, full knowledge is required about the mineralization, proposed mining technology and processing. At this stage a comprehensive feasibility study is undertaken covering capital requirements, returns on investment, payback period and other essentials, in order for the board of directors of the company to make the final decision on developing the prospect into a mine.

When probabilities come close to certainties, a decision might be taken to proceed with underground exploration. This is an expensive and time-consuming operation, involving sinking a shaft or an incline, and pilot mining drifts and galleries. Further drilling from underground positions and other studies will further establish the viability of the orebody.

After the mineralization has been defined in terms of quantity and quality, the design of mine infrastructure starts. The pictures on page 14 show recent plans at the Suurikuusikko gold mine project in Finland where the optimum mining methods combine both open pit and underground mining. Production can start in the open pit while preparing for the underground operation.

With an increasing level of geological information the mineral resources get better confirmed. The feasibility study will take into consideration all economical aspects, as well as the effects of the selected mining method. Depending on the mining method, there could be essential differences between mineral resources and ore reserves, both in terms of quantity and grade.

**Hans Fernberg**

# Finding the right balance in exploration drilling

## Chips or cores?

The question often faced by geologists and contractors is deciding which method of exploration drilling will get the most effective and economical results. These days, the answer is quite likely to be a combination of chip sampling and coring. Three key factors have proved decisive in the successful search for minerals and precious metals: time, cost and confidence. In other words, the time required, the cost of getting the job done, and confidence in the quality of the samples brought to the surface for analysis. This is more a question of basic technology and logic than one of science. But it is interesting to see these three factors expressed as a mathematical formula: confidence over time multiplied by cost, equals profit. With profit, as always, as the driving force.



*There are pros and cons with both RC drilling and core drilling.*

*Substantial savings can be made by pre-collaring holes using RC drilling, once the general location of the mineralized zone has been established.*

## Conventional core drilling

The technique which produces cores of subsurface material, core drilling, is the most commonly used method of obtaining information about the presence of minerals or precious metals, as well as rock formations. However, reverse circulation drilling (RC), which produces samples as chips, is gaining ground.

The reason is easy to see. RC drilling is a faster and more economical way of pre-collaring a deep hole in order to get down to where the orebody is located. Once there, the driller can then decide to continue with RC drilling to extract chips for evaluation, or switch to diamond core drilling to extract cores. In this way, RC drilling becomes the perfect complement to conventional core drilling. Selecting which method to use for actual sampling work depends largely on the preference of the geologists, and their confidence in the quality of the samples. Today, RC drilling has become so advanced that more

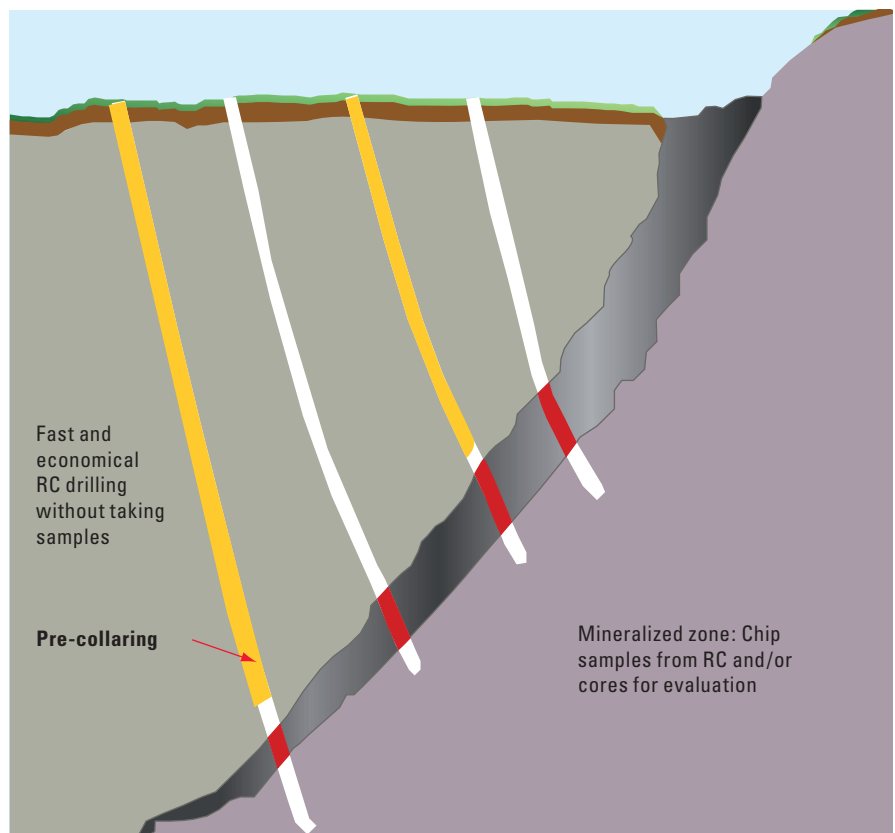

**Total drilling programme 80 holes, 400 m deep. Total 32,000 m of drilling.**

<b>Scenario 1</b> 100% core drilling 457 days	70m core / 24 hours with 1 core drilling rig
<b>Scenario 2</b> 50% RC (pre-collars only), 50% core drilling 301 days	70m core / 24 hours with 1 core drilling rig
<b>Scenario 3</b> 75% RC (pre-collars & full holes), 25% core drilling 223 days	70m core / 24 hours with 1 core drilling rig

In case three core drilling rigs would have been available in scenario 1, expected time is 152 days compared with 457 days.  
 In case three core drilling rigs would have been available in scenario 2, expected time is 149 days compared with 301 days.  
 A rough conclusion gives that the RC rig is somewhat faster than 3 core drilling rigs together.

**Cost ratios.**

457 days	2,580,000 USD
301 day	740,000 USD
223 day	320,000 USD

Approx. cost of RC drilling – 30 USD / metre  
 Approx. cost of core drilling – 80 USD / metre

Table 2.

and more geologists believe that chips are perfectly sufficient as a means of determining ore content. The commercialization of RC drilling started in the 1980s but the technique has certainly been around for much longer.

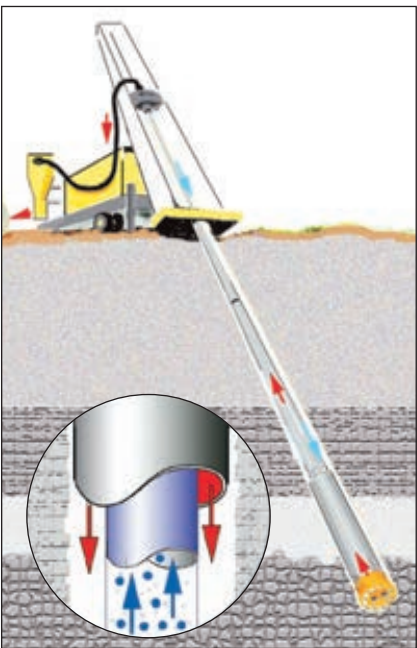

Principles for RC drilling showing flow of compressed air and chips. The sampling collection box is integrated into the cyclone.

Table 1.

As early as 1887, Atlas Copco Craelius had developed a rig that could retrieve cores from depths of 125 m. Confidence in these samples among geologists was high, allowing them to evaluate a piece of solid rock. In those days, time was not necessarily of any great importance and neither was cost, with inexpensive manpower readily available.

However, the demand for such products quickly increased, and availability had to keep pace. This is very much the case today with sharp market fluctuations, and so technology innovators have to find ways to optimize profit in all situations.

**Time factor**

DTH hammers were invented in 1936 and became popular during the 1970s, mainly for water well drilling applications. However, the method proved very useful for prospecting, affording an initial evaluation on the spot of the cuttings emanating from the borehole.

DTH drilling offers a considerably higher drilling speed compared to core drilling, and the method was further developed to increase its performance. Higher air pressures combined with high availability of the hammer are two factors that make it possible to drill faster. Durability of the bit inserts is also much improved, allowing more metres to be drilled without having to pull up the drillstring, further improving efficiency and utilization of the hammer.

The logistics surrounding the drilling programme concerning availability

of parts, fuel, casing, water, and consumables also have a direct influence on the number of metres drilled per shift.

Significant time savings can be achieved by using RC and core drilling in a balanced combination (see table 1). Here we can see that one RC rig can be used to drill enough pre-collars to keep three core drilling rigs running for 24 h/day. The time factors show obvious benefits using a combination of the two methods. In this scenario, a minimum of 25% of the total metres drilled were specified as core drilling.

**Cost factor**

The cost perspective does not have any negative surprises in store as the costs are mostly related to the time factor. The investment in RC rigs and equipment is higher compared to those of core drilling, but as shown in table 2, the costs are reduced when a combination of the two methods is used.

In this example, it is shown that both time and costs favour RC drilling. The figures are easy to evaluate. They vary depending on the location and the local conditions, but the relativity remains the same, and is strongly reflected in the development of the exploration drilling process.

To further shorten time and cost, immediate results from on-site evaluation can be used, for which a scanning process is already available.

However, in the future it may not be necessary to drill to obtain sufficient information about the orebodies, and manufacturers such as Atlas Copco Craelius are already taking up the challenge to develop equipment and technologies with no limits and low environmental impact.

**Confidence factor**

The third variable in the equation is the confidence factor, because investors and geologists place strict demands on contractors to deliver the highest quality geological information. Investors always require a fast return on their investments, and the geologists need solid results for the mine planners. However, whenever a gold nugget is found, the

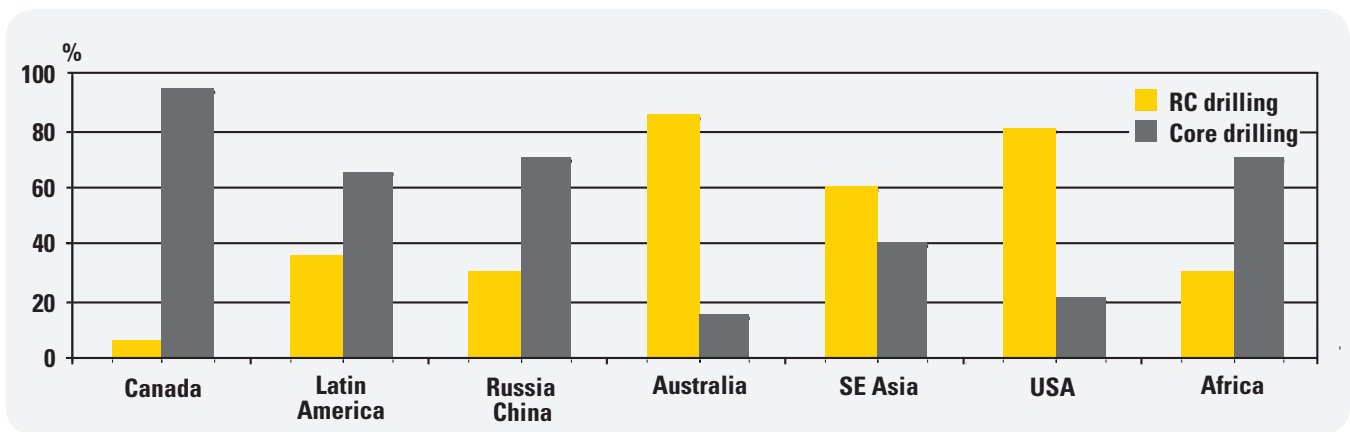

Ratios between core and RC drilling. The figures reflect total exploration expenditures from national statistics for surface and underground.

exploration drilling will not be carried out by the same people, so reliability of information is critical. There are many reasons why geologists should choose their drilling method carefully.

If there is no need for continuous information about the geological formation on the way down, there is no need for samples. It is just a matter of minimizing the drilling time. The geometry of the orebody is already known, and just a reconfirmation of the boundaries is necessary. In this case, RC drilling is an efficient method to use.

A first scanning of virgin territory is being done where the goal is just to obtain a preliminary indication of possible content. In this case, the geologist is not relying on any mineralized structure or geometry. With an evaluation giving positive results, a programme of core drilling is the logical way to continue in order to bring the project to a resource/reserve status. If the mineralized structure is identified but the geometry and rate of content varies, RC drilling is used as an indicator for ensuring continued grade control.

The geologist wants dry and representative samples in order to make optimal evaluations. RC drilling below the groundwater table was previously believed to undermine sample quality. Core drilling therefore remained the only viable method for these depths. Today, the availability of high pressure compressors and hammer tools makes it possible for RC drilling to reduce costs even for these depths.

These days, professional contractors deliver dry sampling down to depths

of 500 m. By sealing off the bit from the rest of the hole it can be kept dry. A correct selection of shroud vs bit tolerance maintains a pressurized zone around the bit. Boosted air pressure is needed to meet the higher water pressure on its way down the hole. In addition, a dry bit drills faster.

It must be remembered that information from a core is crucial in estimating the period of mineralized structures. The core helps the geologist to calculate the cost of extracting the mineral from the ore. Large volumes of rock have to be excavated to obtain just a few grammes of a valuable mineral.

Cores also yield geotechnical data. Data about slope stability can be of the highest importance. Ground conditions are naturally also of great importance and may produce questionable samples if some of the information from fissured zones is left behind in the hole and not collected. In such circumstances, core drilling could be the only alternative.

## Increased usage of RC drilling

RC drilling is on the increase, and may well account for 55% of all metres drilled in 2008. The diagram above shows some estimated ratios between core and RC drilling in different parts of the world in 2002. In terms of metres drilled, RC accounts for 50% and core drilling for 50%. Tradition and environmental impact play large roles. RC rigs are heavy, and are mounted on trucks or track carriers. This fact tends to

favour core drilling rigs, which are much lighter and more adaptable in order to be flown into remote and sensitive environments.

In areas with extremely cold climates and where permafrost is present, RC drilling may have its limitations. Anti-freeze rock drill oil can help to keep the hammer and bottom of the hole free from ice. Other purely practical issues determine the choice of one or the other drilling method.

An intelligent, balanced choice between the two methods is the key to optimal results. The geologist plays an extremely important role in finding this balance, as do the manufacturers such as Atlas Copco Geotechnical Drilling and Exploration, who continue to provide the right tools for the job.

Jan Jönsson

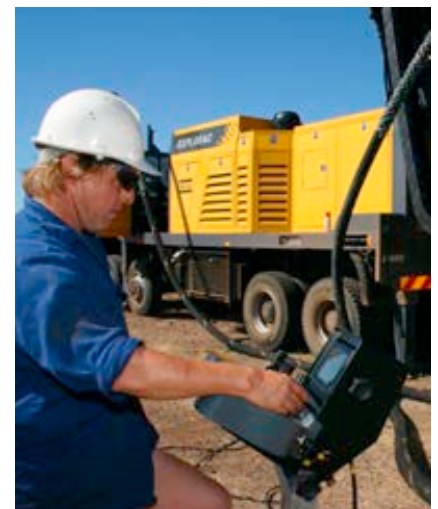

Operating the Explorac 220RC.



Explorac 220RC.

# Underground mining infrastructure

## Maximizing recovery

The underground mine aims for maximum economic recovery of minerals contained in the bed-rock. The orebody is the recovered volume containing valuable minerals, taking ore losses and dilution into account. The amount of ore losses in pillars and remnants, and the effects of waste dilution, will largely depend on the mining method to be applied. Waste dilutes the ore, so miners try to leave it in place, wherever possible, especially when expensive mineral dressing methods are applied. Flotation of sulphide ore is more expensive than magnetic separation of iron ore. Ore close to the surface is mined by open pit techniques, in which the waste rock can be separated by selective blasting and loading, and trucked to the waste dump instead of entering and diluting the ore flow into the concentrator. Subsurface orebodies are exploited by underground mining, for which techniques are more complex. A combination of open pit mining and preparation for future underground mining is commonly used.

## Underground infrastructure

Mining methods used underground are adapted to the rock conditions, and the shape, dimensions, strength and stability of the orebody. In order to work the underground rock mass, infrastructure is required for access to work places, ore production, power supply, transport of ore, ventilation, drainage and pumping as well as maintenance of equipment.

Traditionally, the most common method to transport men, material, ore and waste is via vertical shafts. The shaft forms the access to the various main underground levels, and is the mine's main artery for anything going up or down. Shaft stations, drifts and ramps connect

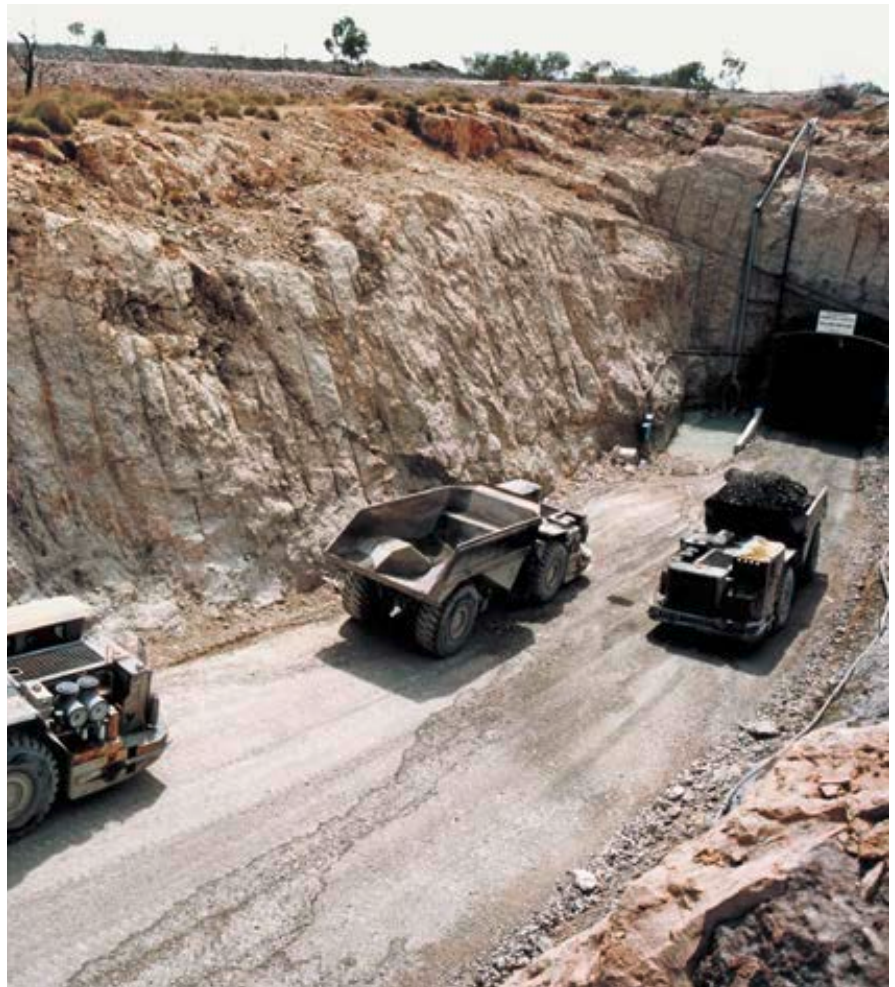

*Ramp access for transport and haulage.*

stopes with orepasses, tramming levels, and workshops for movement of miners and equipment.

Efficient ore handling is important. The blasted ore is loaded from production stopes, via orepasses to a main haulage level, commonly railbound, and thence to the crusher at the hoisting shaft.

The crushed ore is then stored in a silo before transfer by conveyor to the measuring pocket at the skip station, from where it is hoisted to the surface stockpile. To decide on the shaft bottom and main haulage level elevations are crucial, as these are permanent installations offering little or no flexibility in the event that mining progresses below these levels. Consequently extensive

exploration drilling has to be conducted to identify sufficient ore reserves above the main haulage level before final design of the permanent installations can progress.

There is currently a strong tendency to avoid shaft sinking by extending ramps from the surface successively deeper, to depths exceeding 1,000 m. There are a number of locations where the deeper ore is hauled by trucks up ramps to an existing railbound haulage system to the main crusher, from where it can be hoisted to the surface.

## Services

Electric power is distributed throughout the mine, and is used to illuminate work

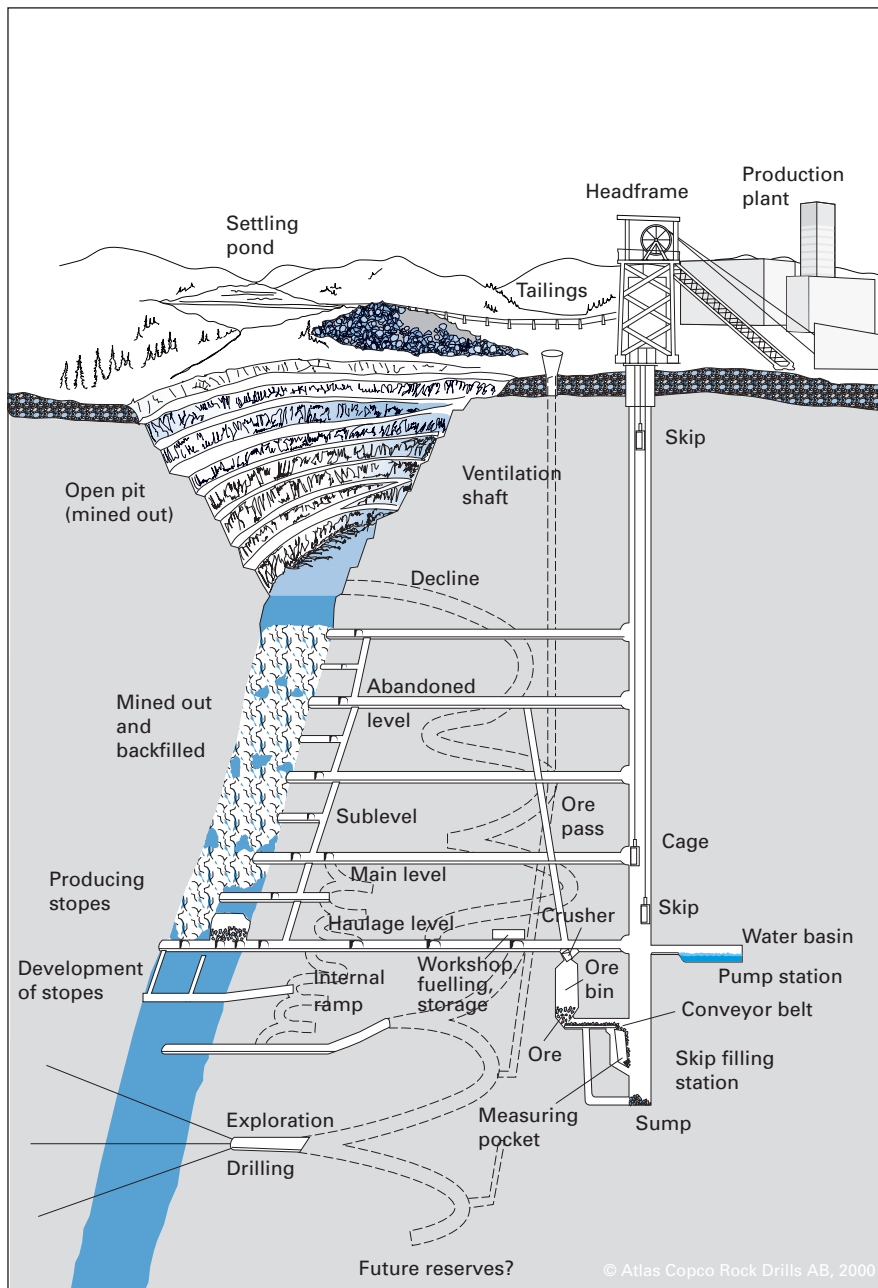

Basic infrastructure required for a typical underground mine.

places and to power drill rigs, pumps and other machines. A compressor plant supplies air to pneumatic rock drills and other tools, through a network of pipes.

Water reticulation is necessary in the mine, wherever drilling, blasting and mucking takes place, for dust suppression and hole flushing. Both ground water and flushing water are collected in drains, which gravitate to settling dams and a pump station equipped with high-lift pumps to surface.

Air quality in mine workings must be maintained at an acceptable health standard. The mine needs a ventilation

system, to remove smoke from blasting and exhaust gases from diesel-powered machines, and to provide fresh air for the workers. This is normally provided via downcast fresh-air shafts. High-pressure fans on surface extract exhaust air through the upcast shafts. Ventilation doors control the underground airflow, passing fresh air through active work areas. Polluted air is collected in a system of exhaust airways for channelling back to the upcast shafts. As most of the infrastructure is located on the footwall side of the orebody, the fresh air is normally channelled via the footwall

towards the hangingwall, from where the exhaust air is routed to the surface.

## Transport infrastructure

Each mining method requires a different underground infrastructure, such as access drifts to sublevels, drifts for longhole drilling, loading drawpoints, and orepasses. Together, they form an intricate network of openings, drifts, ramps, shafts and raises, each with its designated function.

The shaft is a long-lived installation, and may be more than 50 years old. The hoist and cage provide access to the shaft station, which connects with a main level along which trains or conveyors may run. The skip is the most efficient way to hoist ore from underground to surface.

Materials handling may be by utility vehicles or locomotive-hauled trains. The co-ordination of train haulage with shaft hoisting, from level to level, makes the logistics of rail transport complex. Workers in a rail-track mine are required to wait for cage riding until shift changes, or scheduled hours, with material transport only permitted at certain periods. Ore hoisting takes priority over manriding and material transport.

The Load Haul Dump (LHD) loader introduced mines to diesel power and rubber-tyred equipment in the 1970s. This was the birth of trackless mining, a new era in which labour was replaced by mobile equipment throughout the mine. Maintenance workshops are now located underground at convenient points, usually on main levels between ramp positions.

The shaft remains the mine's main artery, and downward development is by ramps to allow access for the machines. On newer mines, as mentioned above, a decline ramp from surface may facilitate machine movements and transport of men and materials, and may also be used for ore transportation by truck or conveyor, eliminating the need for hoisting shafts.

## Ramps and shafts

Mine development involves rock excavation of vertical shafts, horizontal drifts, inclined ramps, steep raises, crusher stations, explosives magazines, fuel stores,



pumphouses and workshops. Drill/blast is the standard excavation method for drifting. Firing sequence for a typical parallel hole pattern is shown to the right. Note that the contour holes are fired simultaneously with light explosives, and that the bottom holes, or lifters, are fired last to shake up the muck pile for faster mucking.

A deep shaft may secure many years of production, until ore reserves above the skip station are exhausted. The shaft can be rectangular, circular or elliptical in profile. Extending the shaft in an operating mine is costly and difficult, requiring both expert labour and specialized equipment.

Drifts and ramps are dimensioned to accommodate machines passing through, or operating inside. Space must include a reasonable margin for clearance, walkways, ventilation ducts, and other facilities. Cross-sections vary from 2.2 m x 2.5 m in mines with a low degree of mechanization to 5.5 m x 6.0 m where heavy equipment is used. Only 5.0 sq m section is sufficient to operate a rail-bound rocker shovel, whereas 25.0 sq m may be needed for a loaded mine truck, including ventilation duct.

Normal ramp grades vary between 1:10 and 1:7, with the steepest grade to 1:5. The common curve radius is 15.0 m. A typical ramp runs in loops, with grade 1:7 on straight sections, reduced to 1:10 on curves.

## Raising and winzing

Raises are steeply inclined openings, connecting the mine's sublevels at different vertical elevations, used for ladderways, orepasses, or ventilation. Inclination varies from 55 degrees, which is the lowest angle for gravity transport of blasted rock, to vertical, with cross-sections from 0.5 to 30 sq m. When the excavation of raises is progressing downwards they are called winzes.

Manual excavation of raises is a tough and dangerous job, where the miner climbs the raise by extending the ladderway, installs the temporary platform, and drills and charges the round above his head. As such, manual raises are limited to 50 m-high. However, the efficiency can be greatly improved by using a raise climber up to 300 m.

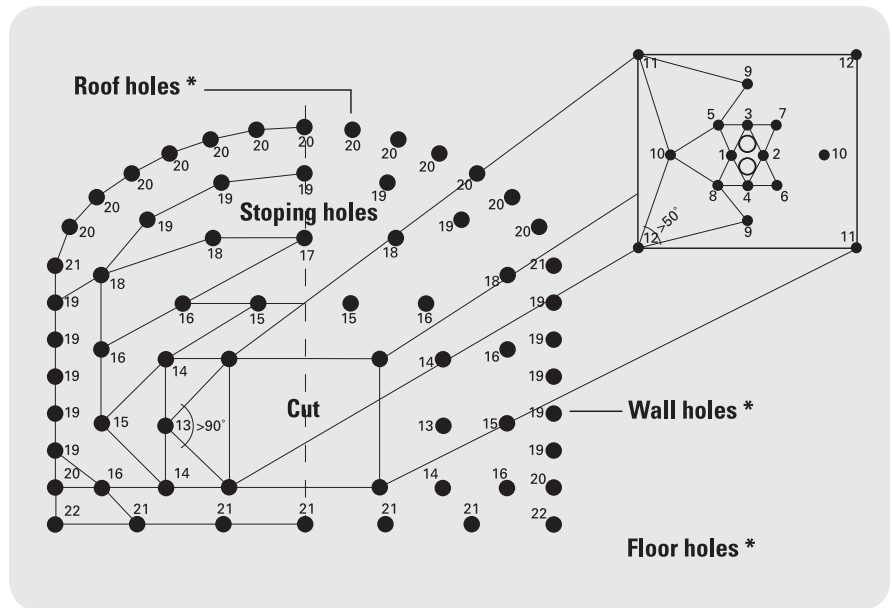

Firing sequence of a typical hole pattern (\*contour holes).

The drop raise technique is used for slot raises and short orepasses, using longhole drilling and retreat blasting from bottom to top, see figure below. Inverted drop raising is performed the other way around.

## Raiseboring

The raiseboring machine (RBM) may be used for boring ventilation raises, orepasses, rock fill passes, and slot raises.

It provides safer and more efficient mechanized excavation of circular raises, up to 6 m-diameter.

In conventional raiseboring, a downward pilot hole is drilled to the target level, where the bit is removed and replaced by a reaming head. The RBM then reams back the hole to final diameter, rotating and pulling the reaming head upward. The cuttings fall to the lower level, and are removed by any convenient method. An RBM can also

Long hole drilling alternative to raiseboring.

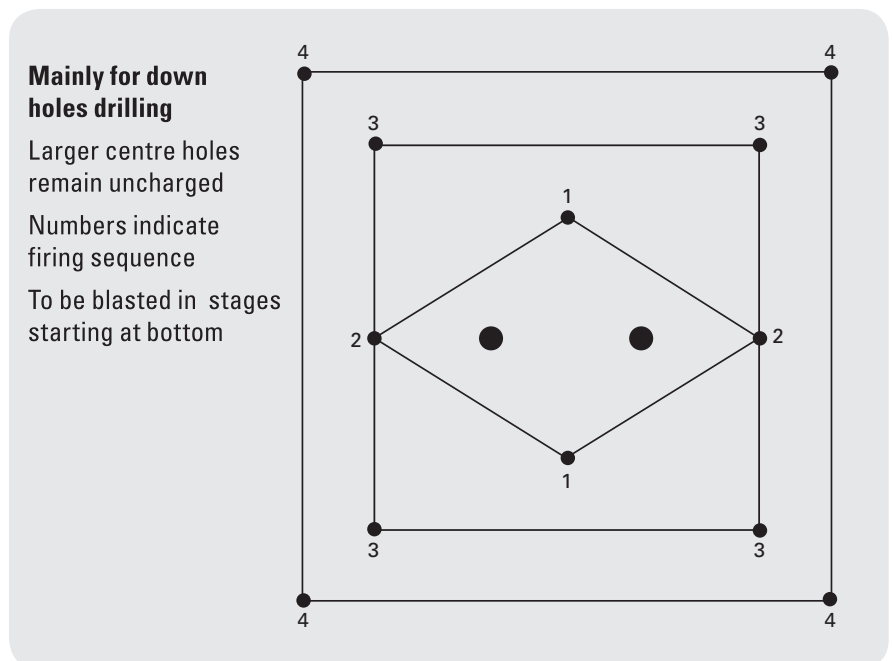



*Atlas Copco Robbins 53RH-EX raiseboring machine.*

be used to excavate raises where there is limited, or no, access to the upper level. In this boxhole boring method, the machine is set up on the lower level, and a full diameter raise is bored upward. This method is used for slot hole drilling in sublevel caving and block caving methods. The cuttings are carried by gravity down the raise, and are deflected

*Simba MC 6-ITH with slot hammer.*



from the machine by the use of a muck collector and a muck chute.

An alternative method to excavate box holes is to use longhole drilling with extremely accurate holes to enable blasting in one shot. The Simba MC 6-ITH shown below is modified for slot drilling so that the holes will closely follow each other, providing sufficient open

space for consecutive blasting. The drilling and blasting results are shown below. Hole opening, or downreaming, using a small-diameter reamer to enlarge an existing pilot hole, can also be carried out by an RBM.

The capital cost of an RBM is high, but, if used methodically and consistently, the return on investment is very worthwhile. Not only will raises be constructed safer and faster, they will be longer, smoother, less disruptive than blasting, and yield less overbreak. The rock chips produced by an RBM are consistent in size and easy to load.

The BorPak is a small, track-mounted machine for upward boring of inclined raises. It starts boring upwards through a launching tube. Once into rock, grippers hold the body, while the head rotates and bores the rock fullface. BorPak can bore blind raises with diameters from 1.2 m to 1.5 m, up to 300 m-long.

### **Gunnar Nord**

*Holes at breakthrough after 32 m.*



*Sufficient expansion space is created for production blast holes to follow.*

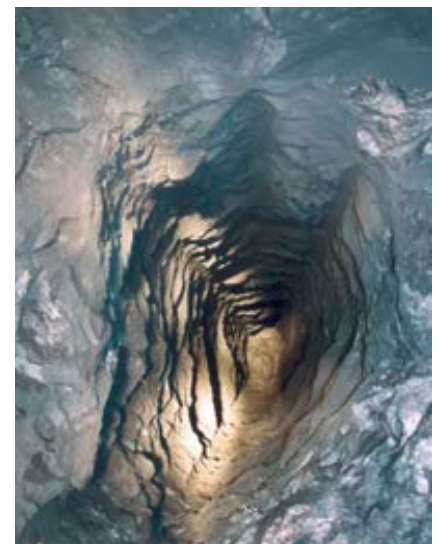

# Rapid development in mining

## Earlier exploitation

High metal prices are leading many mining operations to explore rapid development techniques to reach and exploit valuable ore reserves as quickly as possible. Here we look at how mines can benefit from techniques traditionally employed by construction. Rapid tunnelling has always been in focus for underground construction engineers because their profit is mainly determined by how fast the job can be completed. It is often stated that the costs for tunnelling are 70% time related. For the miner, the situation is somewhat different. The goal has always been to fulfil production targets with the highest possible utilization of equipment and manpower. Now, however, there is a growing interest in the mining industry to achieve rapid drifting in mine preparation, and an awareness of the potential benefits.

## In perspective

Advance rates in tunnelling, despite substantial improvements in rock drilling technology, have not increased radically in recent years. Since the 1970s, the rate at which tunnels have been built has only increased by around 1% annually. The improvements from 1973 to 2007 are described in Figure 1 with the typical time needed for the different operations at the tunnel face for a 70 m<sup>2</sup> road tunnel. The bars represent the time needed for the operations and metres advance of the tunnel.

One reason for this is safety, the positive effect of which can clearly be seen in Figure 2. An example is charging of blast holes concurrent with drilling is no longer permitted, except in a few countries. Implementation of stricter rules on safety and the working environment has had the effect of reducing accident rates while limiting advance rates. The figure of 1% for the annual increase in advance rates was supported by a paper on advanced rates in tunnel construction which was presented at the

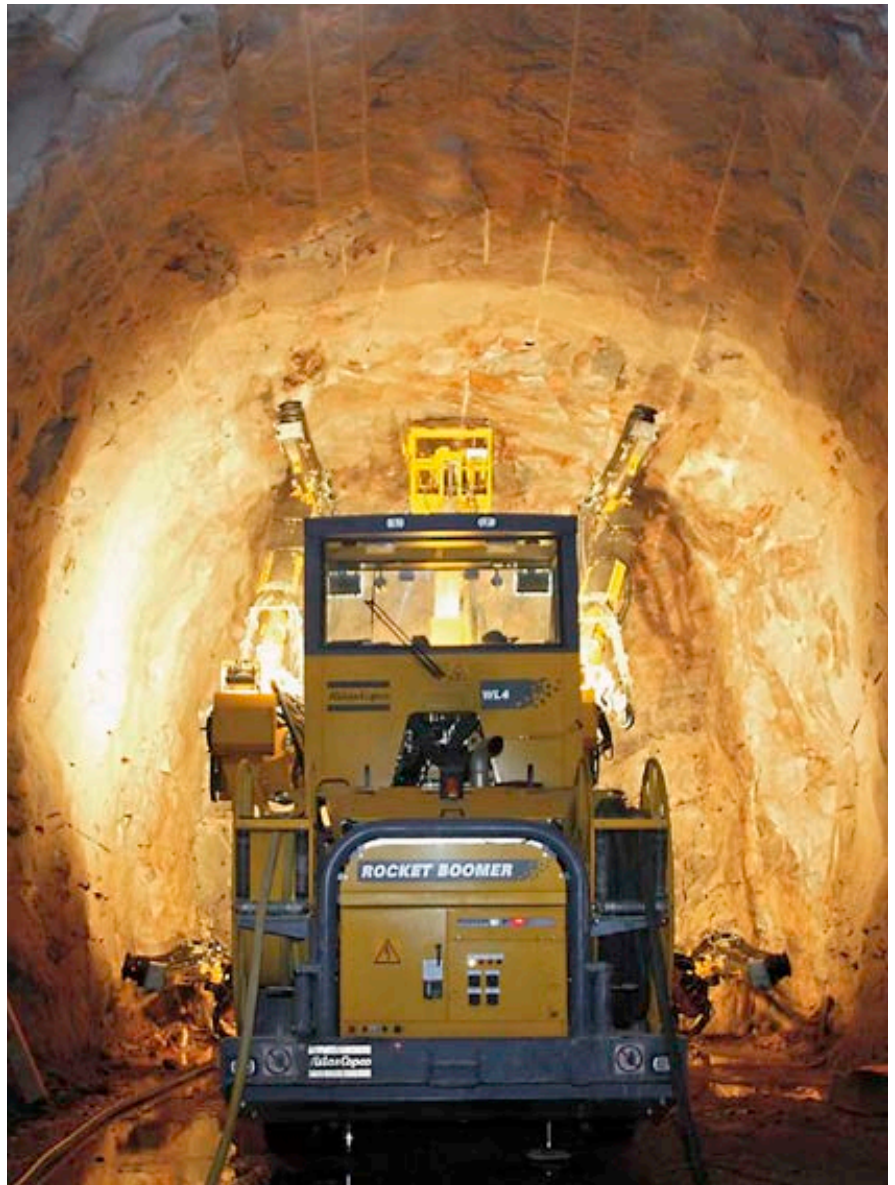

*The Savio tunnel in Helsinki Finland with an Atlas Copco Boomer XL4 C and COP 3038 rock drills. Excavating a wider tunnel than had been specified speeded up completion.*

2007 Prague ITA World Tunnel Congress by S. Zare and A. Bruland from NTNU, Trondheim, Norway. This showed how productivity in civil engineering has improved over the years for a 60 sq m tunnel. According to the paper, annual productivity improvement equates to 1.5% over a 30 year period, excluding time for rock support. The rate of advance in metres per week can be seen in the bar chart on Figure 3. A few areas that might help improve mine drifting will

therefore be highlighted. This article is intended to serve as a starting point to stimulate discussion on what tunnelling techniques can be adapted for the benefit of rapid development in mining.

## Tunnel size and profile

It has long been believed that the smaller the tunnel, the faster the excavation rate. This is not true. Tunnel profile, support measures, excavation sequence and

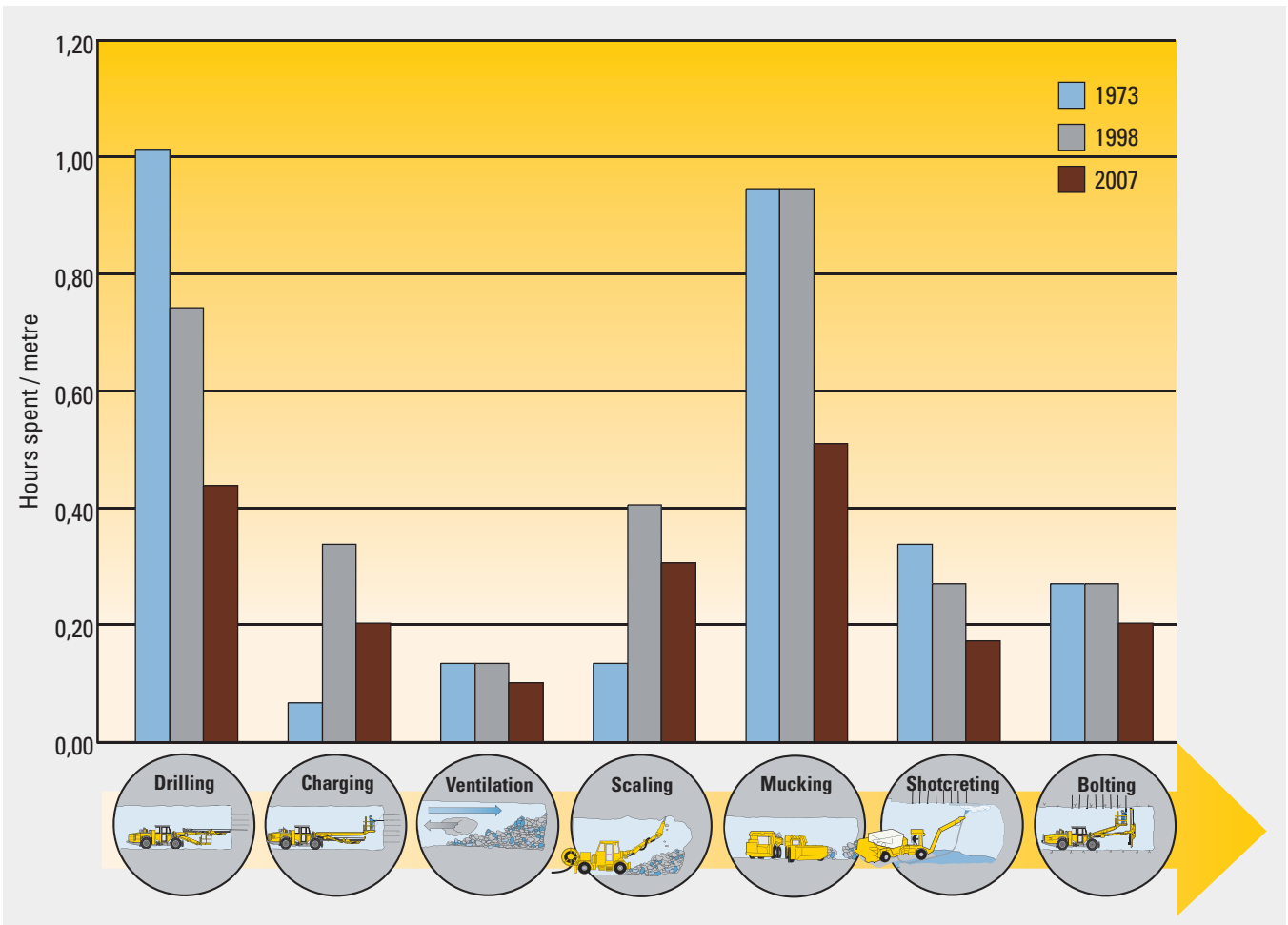
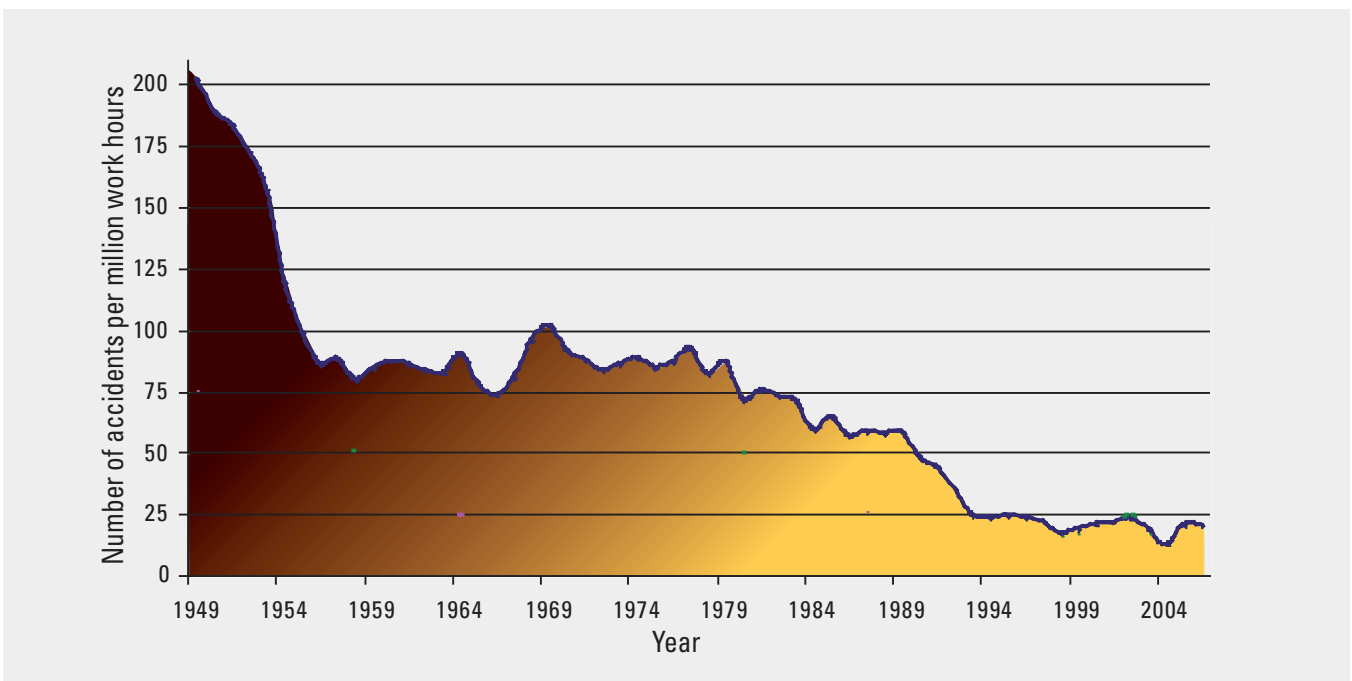

Fig 1: The tunnelling cycle with various sequential operations at the tunnel face, with hours spent per metre of advance.

Fig 2: Accident rates in Swedish underground mines 1949–2007. Thanks to safety legislation and technological innovations, there has been a steady decline in accident rates in underground operations over the years. Progress in reducing the overall tunnelling cycle time however, has been more limited (Data courtesy of SveMin).



equipment used are the input parameters when establishing the most effective tunnel size in relation to excavation speed.

For example, a single-track railway tunnel has been completed in Helsinki, Finland. The client requested a tunnel 8.8 m high and 6.6 m wide. On part of the project, the contractor offered a tunnel that was 7.5 m wide instead of the requested 6.6 m.

This design, with its larger cross section, meant that the tunnel could be completed earlier, and at a lower cost, because the loading of the blasted rock could be done at a much higher rate in a larger tunnel.

Another technique is to alter the shape of the tunnel, when possible, to allow for the loading of rock directly at the face. An example of this is the asymmetric tunnel being built at Sauda, Norway. The offset shape of the tunnel allowed trucks to be loaded with blasted rock directly at the face, speeding up the entire working cycle. Increasing advance rates by using an alternative tunnel profile is something that should be easier to implement for mines than for civil engineering contractors because mines have more freedom to decide the shape of their drifts.

## Length of rounds

Excavating drifts by drill and blast requires sequential operations at the tunnel face, each characterized by the mobilization and demobilization of gear, the time allocated for which is practically the same, irrespective of the length of the round.

By extending the round from 4 m to 5 m, some 90 minutes is saved over 20 m of tunnel. For a long tunnel project, this time saving can become significant. To solve the problem of drilling boltholes where the feed exceeds the height and width of the tunnel, a telescopic feed can be employed.

## Support work

The tunnelbuilder tries to determine what the most likely rock classes are for the coming rounds, so that the tunnelling activities can be planned in an optimal way. The aim is to put in just as much rock

support as is needed at the face. The contractor will then install the remaining support well behind the face in order to reduce the time of support activities at the face, and advance as quickly as possible.

Mine drifting is mainly carried out in connection with mine preparation. The variation in ground conditions is often less than for a typical civil engineering tunnel project. Drifting runs in parallel at many faces, and the aim is not to advance a single face as fast as possible, but to excavate each tonne as economically as possible.

In this situation, it is cost effective to install all the bolts and the shotcrete needed for final support right at the face, as this will mean savings in terms of mobilization time and simplicity. It will, however, hamper the advance rate of a prioritized heading. To summarize, it can be said that civil tunnel construction is characterized by a high degree of flexibility. As a result, the full potential of faster tunnelling can be achieved, whenever the right conditions present themselves.

## Scaling

Scaling is where drifting and tunnelling deviate most when it comes to performance. This is not surprising when considering the comparable variations in rock quality.

In tunnelling, along with the roof and walls, the tunnel face is also scaled in

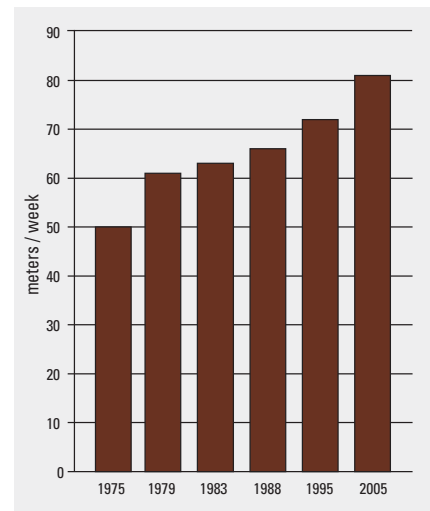

Fig 3: The average rate of advance, excluding rock support, by contractors 1975-2005 in 60 m<sup>2</sup> tunnels. Source: Ntnu, Trondheim, Norway, presented at the world tunnel congress, Prague, May, 2007.

order to achieve a clean and stable face for drilling. A consequence of this is that the scaling operation takes a long time. In good rock conditions, the roof and walls will not yield any falling rock, allowing shotcreting to be carried out well behind the tunnel face. In many cases, shotcrete is applied some 50 m behind the face, even in large tunnels.

Rapid development results from improvements in many other areas such as communication, safety regulations, and advances in equipment and technology.

## Gunnar Nord

*Boltec LC bolting.*



# Principles of raiseboring

## Efficiency and safety

Raiseboring is the process of mechanically boring, drilling or reaming a vertical or inclined shaft or raise between two or more levels. Some 40 years ago, the world's first modern raiseboring machine was introduced by the Robbins Company. It launched a revolution in underground mining and construction, and the technique is now accepted as the world standard for mechanical raise excavation. New products from Atlas Copco, such as the BorPak, concepts such as automatic operation and computerization, and techniques such as horizontal reaming, are creating exciting new opportunities in the underground environment. Atlas Copco Robbins supplies the complete raiseboring package for all situations, together with technical and spares backup.

## Raiseboring concept

The raiseboring machine (RBM) is set up at the surface or upper level of the two levels to be connected, and a small-diameter pilot hole is drilled down to the lower level using a string of drill pipes and a tricone bit. A reamer is then attached to the drill string at the lower level, and the RBM provides the rotational torque and pulling power to ream back to the upper level. The cuttings from the reamer fall to the lower level for removal. Raise bore holes of over 6 m-diameter have been bored in medium to soft rock, and single passes in hard rock can be up to 1 km in length.

Advantages of raiseboring are that miners are not required to enter the excavation while it is underway, no explosives are used, a smooth profile is obtained, and manpower requirements are reduced. Above all, an operation that previously was classified as very dangerous can now be routinely undertaken as a safe and controlled activity.

Specific applications of bored raises in mining are: transfer of material; ventilation; personnel access; and ore



Robbins 73RH C derrick assembly layout.

Raiseboring process.

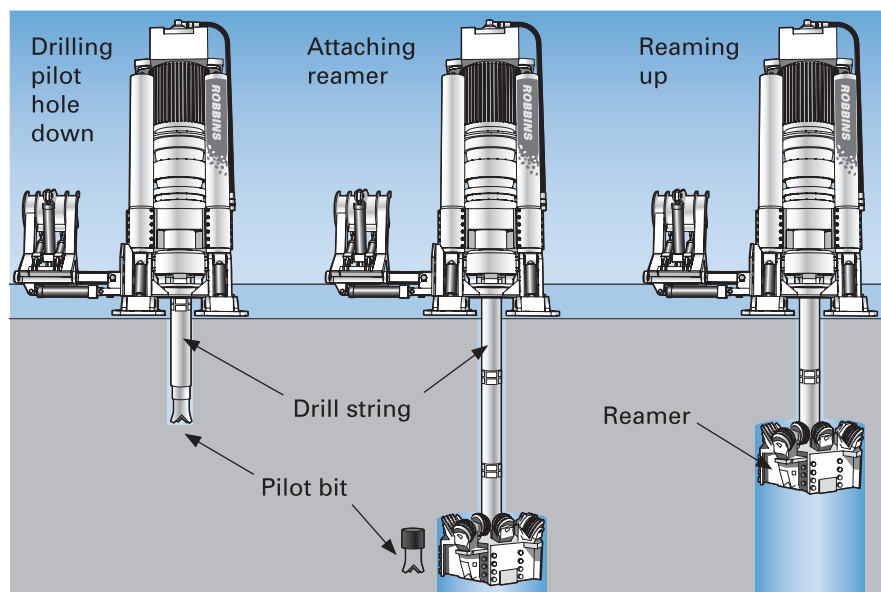

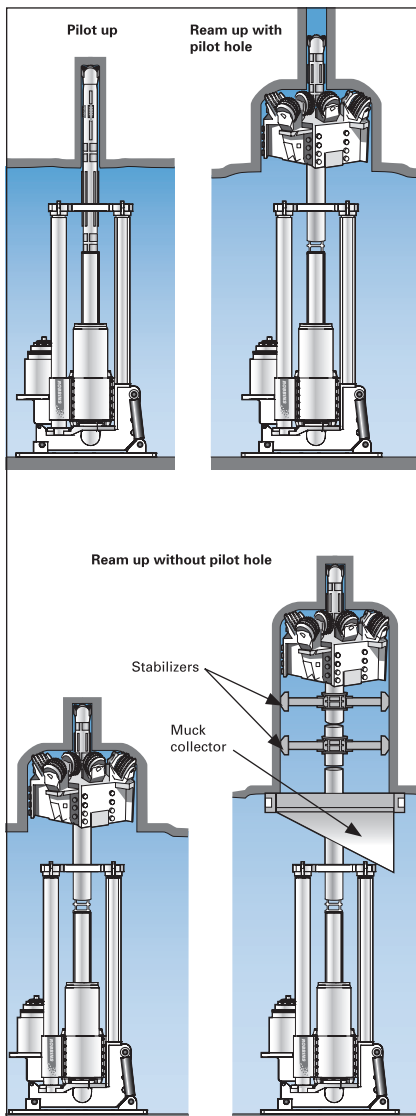

Boxhole boring.

production. Standard RBMs are capable of boring at angles between 45 degrees and 90 degrees from horizontal, and with minor adjustment can actually bore at angles between 45 degrees and horizontal.

A whole host of methods of mechanical raise and shaft excavation have been developed around the use of the RBM. These include boxhole boring, blind shaft boring, rotary drilling, down reaming, pilot up/ream down, pilot down/ream down, hole opening, and BorPak.

## Alternative boring methods

Boxhole boring is used to excavate raises where there is limited access, or no access at all, to the upper level. The machine is

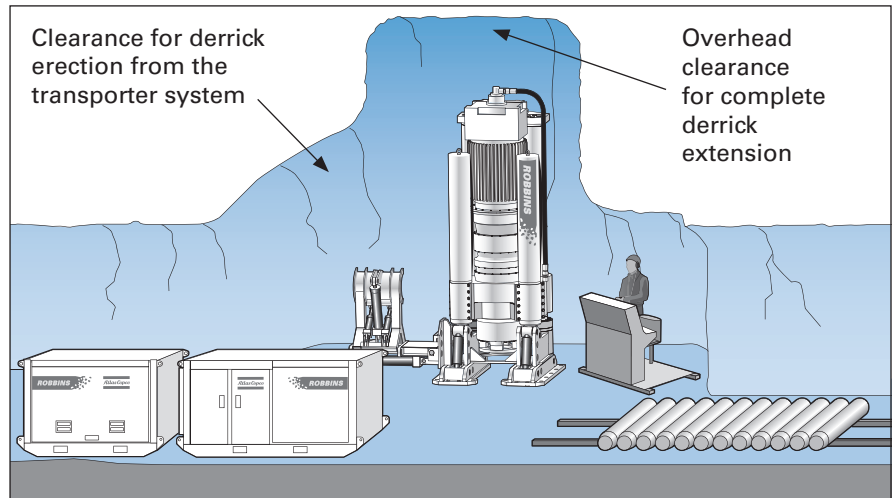

Typical raiseboring underground site showing overhead clearance.

set up at the lower level, and a full diameter raise is bored upward. Stabilizers are periodically added to the drill string to reduce oscillation and bending stresses. Cuttings gravitate down the hole and are deflected away from the RBM at the lower level.

Blind shaft boring is used where access to the lower level is limited, or impossible. A down reaming system is used, in which weights are attached to the reamer mandrel. Stabilizers are located above and below the weight stack to ensure verticality of the hole. Cuttings are removed using a vacuum or reverse circulation system.

Rotary drilling is used for holes up to 250 mm-diameter, and is similar in concept to pilot hole drilling in that a bit is attached to the drill string to excavate the required hole size.

Down reaming involves drilling a conventional pilot hole and enlarging it to the final raise diameter by reaming from the upper level. Larger diameter raises are achieved by reaming the pilot hole conventionally, and then enlarging it by down reaming. The down reamer is fitted with a non-rotating gripper and thrust system, and a torque-multiplying gearbox driven by the drill string. Upper and lower stabilizers are installed to ensure correct kerf cutting and to reduce oscillation.

Pilot up/ream down was a predecessor of modern raiseboring techniques using standard drilling rigs. Pilot down/ream down, or hole opening, employs a small diameter reamer to follow the

pilot hole. Stabilizers in the drill string prevent bending.

The BorPak is a relatively new machine for blind hole boring which climbs up the raise as it bores. It comprises a guided boring machine, power unit, launch tube and transporter assembly, conveyor and operator console. Cuttings pass through the centre of the machine, down the raise and launch tube, and onto the conveyor. The BorPak has the potential to bore holes from 1.2 m to 2.0 m-diameter at angles as low as 30 degrees from horizontal. It eliminates the need for a drill string and provides the steering flexibility of a raise climber.

## Raiseboring machine

The raiseboring machine (RBM) provides the thrust and rotational forces necessary for boring, as well as the equipment and instruments needed to control and monitor the process. It is composed of five major assemblies: the derrick; the hydraulic, lubrication, and electrical systems; and the control console.

The derrick assembly supplies the rotational and thrust forces necessary to turn the pilot bit and reamer, as well as to raise and lower the drill string. Baseplates, mainframe, columns and headframe provide the mounting structure for the boring assembly. Hydraulic cylinders provide the thrust required for lowering and lifting the drillstring, and for drilling and reaming. The drive train assembly, comprising crosshead, main drive motor, and gearbox, supplies the

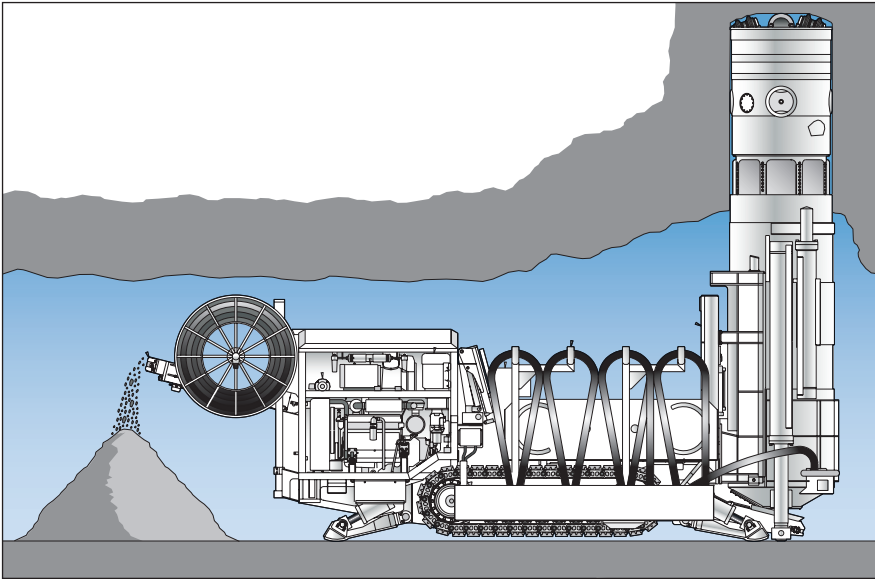

Typical operating installation of the BorPak machine.

rotational power to the drill string and cutting components.

#### Four types of main drive motor systems are available:

AC, DC, hydraulic and VF. The gearbox mounts directly to the main drive motors,

employing a planetary reduction for its compactness. The hydraulic power unit is skid-mounted, and comprises the necessary reservoir, motors, pumps, valves, filters and manifolds.

The lubrication system ensures proper delivery of lubricating oil to the

high-speed bearings and other selected components of the drive train assembly gearbox, and comprises pump, motor, filter, heat exchanger, flow meter, and reservoir with level gauge, thermometer and breather.

The electrical system assembly consists of an enclosed cabinet containing the power and control distribution hardware and circuitry for the entire raise-boring operation.

The control console provides for both electrical and hydraulic functions, offering meter readouts for main operating parameters.

Computerization of the raiseboring functions is also offered, using Atlas Copco's well-tried PC based RCS system.

## Acknowledgements

*This article has been prepared using The Raiseboring Handbook, Second Edition, researched and compiled by Scott Antonich, as its main reference.*

Robbins 73RM-VF set up in a workshop.





# Mechanized bolting and screening

## Utilization is the key

In tunnelling operations, it is quite common to use the same equipment for all drilling requirements. These days, a single drill rig can accommodate drilling for face blasting, bolt holes, protection umbrellas, and drainage. As there are normally only one or two faces available for work before blasting and mucking, it is difficult to obtain high utilization for specialized equipment such as mechanized bolting rigs. By contrast, in underground mining, especially where a number of working areas are accessible using methods such as room and pillar, high utilization of specialized equipment can be expected. This is where mechanized bolting and screening is rapidly taking root, for speed, safety and consistency.

## Specializing for safety

There was a time when underground mining and safety were terms not commonly referred to in the same sentence. However, times have changed, and today safety is given a place of prominence in the operational priorities of the mining industry.

Freshly blasted openings leave considerable areas of loose rock, which must be removed to prevent fall-of-ground injuries. Improvements in drilling and blasting techniques have helped to significantly reduce the amount of this loose rock. Scaling, which is the most hazardous part of the work cycle, is used to remove loose rock.

Subsequent blasting might result in additional rock falls, especially in fractured ground conditions. Screening or shotcreting, as a means of retention of this loose rock, is often used in combination with rockbolting. Screening, which is a time-consuming operation, is common practice in Canada and Australia. Since the 1960s and 1970s, considerable effort has been spent on



*Mechanized scaling with hydraulic hammer.*

mechanizing underground operational activities, including the rock excavation cycle. Within the drill-blast-mucking cycle repeated for each round, the drilling phase has become fully mechanized, with the advent of high productivity hydraulic drill jumbos.

Similarly, blasting has become an efficient process, thanks to the development of bulk charging trucks and easily configured detonation systems. After only a short delay to provide for adequate removal of dust and smoke by high capacity ventilation systems, the modern LHD rapidly cleans out the muck pile.

These phases of the work cycle have been successfully mechanized, and modern equipment provides a safe operator environment.

By contrast, the most hazardous operations, such as scaling, bolting and screening, have only enjoyed limited progress in terms of productivity improvements and degree of mechanization. The development of mechanized scaling and bolting rigs has been slower, mainly due to variations in safety rules and works procedure in specific rock conditions.

To summarize, equipment manufacturers have had difficulty in providing globally accepted solutions. Nevertheless,

there is equipment available from Atlas Copco to meet most of the current demands of miners and tunnellers.

## Mechanization stages

Various methods of mechanized bolting are available, and these can be listed under the following three headings.

### Manual drilling and bolting

This method employs light hand held rock drills, scaling bars and bolt installation equipment, and was in widespread use until the advent of hydraulic drilling in the 1970s. Manual methods are still used in small drifts and tunnels, where drilling is performed with handheld pneumatic rock drills. The bolt holes are drilled with the same equipment, or with stopers. Bolts, with or without grouting, are installed manually with impact wrenches. To facilitate access to high roofs, service trucks or cars with elevated platforms are commonly used.

### Semi-mechanized drilling and bolting

The drilling is mechanized, using a hydraulic drill jumbo, followed by manual installation of the bolts by operators working from a platform mounted on the



Mechanized cablebolting with Cabletec LC.

drill rig, or on a separate vehicle. The man-basket, as a working platform, limits both the practical working space and the retreat capability in the event of falling rock. In larger tunnels, the bolt holes are drilled with the face drilling jumbo.

### Fully mechanized work cycle

A special truck, equipped with boom mounted hydraulic breakers, performs the hazardous scaling job with the operator remotely located away from rock falls. Blast holes are drilled in the face using a drill jumbo, and all functions in the rock support process are performed at a safe distance from the rock to be supported. The operator controls everything from a platform or cabin, equipped with a protective roof.

Where installation of steel mesh is undertaken, some manual jobs may still be required. Mesh is tricky to handle, because of its shape and weight, and this has hampered development of fully automated erection.

### Quality of bolting

In 1992, it was reported that independent studies were indicating that as many

as 20-40% of cement and resin grouted bolts in current use were non-functional. Tunnellers were reporting that they were not installing bolts close to the working face because they might fall out when blasting the round. Obviously, a large proportion of rockbolts were being installed for psychological reasons, rather than for good roof and face support and a safe working environment.

However, by using a mechanized installation procedure, the quality of installation improves. The bolt can be installed directly after the hole has been drilled; the grout can be measured and adjusted to the hole size; and bolt installation can be automated, which is especially important when using resin cartridges, where time and mixing speed are crucial. It can be proved that mechanization and automation of the rockbolting process offers improved quality and safety.

While mining companies and equipment manufacturers, especially in Canada, focused their development on improving semi-mechanized roof support, evolution in Europe concentrated on fully mechanized bolting. During the 1990s, progress accelerated, and today, around 15% of all bolting in underground

mines worldwide is carried out by fully mechanized bolting rigs.

However, compared to mechanization of face drilling and production drilling, this level of acceptance is far from impressive, and the industry has been slow to accept the principle.

The obvious positive safety aspects of mechanized rockbolting have been sidelined by considerations relating to the scale of operations and the type of equipment available. Hence the higher acceptance in mining, where several faces are operated simultaneously. For tunnelling applications, where the rate of advance is of prime importance, the economic criteria might be different.

Also, as there are more functions incorporated into the average rockbolter when compared to a drill jumbo. Bolting units are exposed to falling rock, or cement from grouting, both of which impact upon maintenance costs.

### Significant improvements

When Atlas Copco introduced its current series of mechanized rock bolting units, a wide range of radical improvements was incorporated.

Based on the unique single feed system with cradle indexing, the latest mechanized bolting unit, MBU, is considerably more robust, and less sensitive to falling rock, than its predecessor. Holes are easy to relocate, and the stinger cylinder improves collaring and the ability to install bolts under uneven, rugged roof conditions.

Major re-engineering has resulted in 30% fewer parts. Less maintenance and stock inventory are required, and high availability has been recorded.

Furthermore, the chain feeds used in the new Boltec series feature an automatic tensioning device, which guarantees even and strong feed force for the rock drill, while a stinger cylinder improves collaring and the ability to work under uneven roof conditions. The completely redesigned drill steel support provides sufficient space for bolt plates passing through, and facilitates extension drilling.

The most outstanding benefit, however, is the computer-based Rig Control System, RCS. This system, which has already been successfully incorporated

on the latest Boomer and Simba series of drill rigs, offers simplified fault detection, operator interactivity, and the basis for logging, storing and transferring of bolt installation production and quality data.

The Boltec is equipped with the new rock drill, the COP 1132, which is short and compact, and features a modern double damping system which, combined with the RCS, transmits maximum power through the drill string. The long and slender shaped piston, which is matched to the drill steel, permits high impact energy at high frequencies resulting in long service life of drilling consumables and efficient drilling. Furthermore the COP 1132 is fully adjustable for various rock conditions.

## Versatility and ergonomics

Modern bolting rigs can handle installation of most types of rockbolts commonly used today such as Swellex, as well as resin and cement grouted rebars. Using the new Boltec series based on RCS, the operator copes easily with the more demanding cement grouting and resin cartridge shooting applications, by controlling all functions from the cabin seat.

Up to 80 cartridges can be injected before the magazine needs refilling. Also, because meshing is often carried out in combination with bolting, an optional screen handling arm can be fitted parallel to the bolt installation arm, to pick up and install the bulky mesh screens. Up to 5 different pre-programmed cement-water ratios can be remotely controlled.

The new generation rigs offer the operator a modern working environment in a safe position. Low positioned, powerful lights provide outstanding visibility of the entire drilling and bolting cycle.

The new Boltec family has two members equipped with RCS and the fully automated cement handling system: the Boltec MC, for bolt lengths of 1.5-3.5 m and roof heights up to 8 m; and the larger Boltec LC for bolt lengths of 1.5-6.0 m, primarily for large tunnelling projects having roof heights of up to 11 m. The positive response from operators and mechanics confirms that this latest generation of Boltec will pave



*Boltec LC with screen handling arm.*

the way for further acceptance of mechanized bolting.

## Screen installation

In Canadian mines the combination of rockbolts and screen, or wire mesh, is commonly used for rock support. Since rock reinforcement is potentially one of the most dangerous operations in the work cycle, mechanized rockbolting has become more popular. A Boltec MC using RCS, equipped with screen handling arm, has been in use for a couple of years at Creighton Mine installing screen with split-set bolts.

In general, the screen is 3.3 m-long x 1.5 m-wide, and is installed in both roof and walls, down to floor level. Typical

spacing of bolts is 2.5 ft. Three different types of bolts are used, depending on rock conditions, and all bolting must be done through the screen, with the exception of pre-bolting at the face. In general, galvanized split-set are used for wall bolting, while resin grouted rebar or mechanical bolts are used in the roof, and Swellex in sandfill.

Once the screen handling arm has picked up a screen section and fixed it in the correct position, the powerful COP 1132 hydraulic rock drill quickly completes the 35 mm diameter, 6 ft and 8 ft holes. The bolting unit remains firmly fixed in position after the hole is drilled, and the cradles are indexed, moving the bolt, with plate, into position. The bolt feed, combined with the

impact power from a COP 1025 hammer, is used for installing split-set bolts. The complete rock reinforcement job is finished in just a few minutes.

## Boltec MC flexibility

The Boltec MC delivered to the Creighton mine is capable of handling several types of bolts: split-set, mechanical anchors, resin grouted rebar and Swellex. The switch of accessories between different bolt types takes 5-10 minutes. To minimize water demand during drilling, water mist flushing is used. The Boltec MC can also be equipped with a portable operator's panel connected by a 50 m-long cable.

Cartridge shooting is remote controlled for the Boltec MC, and up to 80 cartridges can be injected before refilling is needed. A unique feature is the possibility to use two different types of cartridges, with fast or slower curing times, housed separately in the dual cartridge magazine. The operator can select how many cartridges of each type to inject into any hole. For instance, he can inject two fast curing cartridges for the bottom of the hole, and follow up with slower-curing cartridges for the rest of the hole, all without leaving his operator's panel!

## Cabletec LC for cable bolting

Atlas Copco has developed a fully mechanized rig for drilling and cable bolting by a single operator. The first unit went into operation some years ago at Outokumpu's Kemi chromite mine in northern Finland, and a second unit went to Chile. Today, a significant number of units are sold to many mines around the world. The Cabletec LC is based on the long hole production drilling rig Simba M7, with a second boom for grouting and cable insertion.

The booms have an exceptionally long reach and can drill a line of up to 4.7 m of parallel holes from the same rig setup. Likewise, the booms can reach up to 8 m roof height, allowing the Cabletec LC to install up to 25 m-long cable bolt holes in underground mining applications such as cut and fill mining and sublevel stoping. Furthermore, the

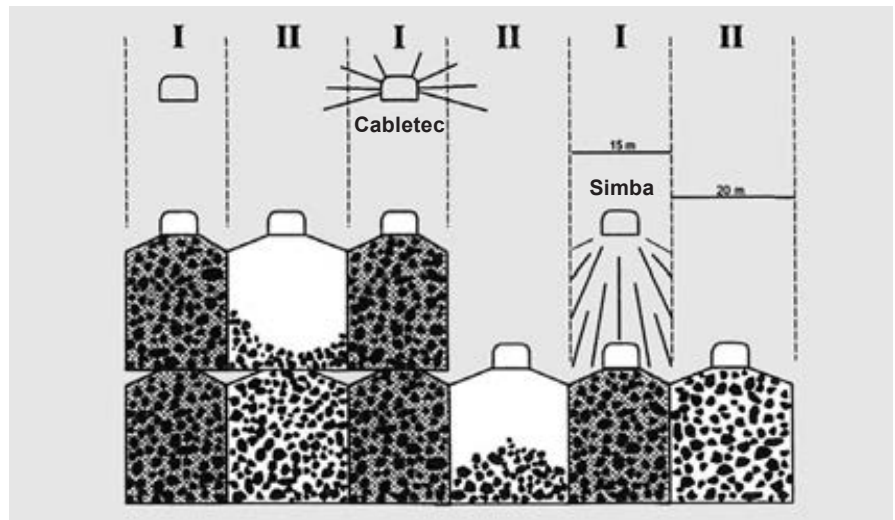

Cabletec drilling and installing cablebolts upwards, and Simba drilling blast holes downwards at Kemi mine.

drill unit can rotate 360 degrees and tilt 10 and 90 degrees, backwards and forwards respectively. The new rig is designed on proven components and technology featuring two booms - one for drilling and the other for grouting and cable insertion. It also features an on-board automatic cement system with WCR (Water Cement Ratio) control. All these features facilitate a true single operator control of the entire drilling and bolting process. The two-boom concept has drastically reduced the entire drilling and bolting cycle time and, by separating the drilling and bolting functions, the risk of cement contaminating the rig is eliminated. The operator is able to pay full attention to grouting and cable insertion, while drilling of the next hole after collaring is performed automatically, including pulling the rods out of the hole.

Cabletec is equipped with the well proven COP 1838 ME hydraulic rock drill using reduced impact pressure with R32 drill string system for 51 mm hole diameter or R35 for 54 mm holes. Alternatively, the COP 1638 rock drill can be used for soft rock conditions. Maximum

hole length is 32 m using 6 ft rods and RHS. The cable cassette has a capacity of 1,700 kg and is readily refilled thanks to the fold-out cassette arm. The cement mixing system is automated, comprising a cement silo containing 1,200 kg of dry cement. The cement is mixed according to a pre-programmed formula, resulting in a unique quality assurance of the grouting process. The cement silo capacity is adaptable for up to 25 m-long, 51 mm-diameter holes.

To date, most holes have been drilled in the 6-11 m range, for which the rig has grouted and installed cable at a rate of more than 40 m/h. Depending on type of geology and hole diameter chosen, the drilling capacity can vary between 30 and 60 m/h.

## Conclusion

Rock support, including scaling, bolting, screening, and cable bolting, is still the bottleneck in the working cycle in underground mining and tunnelling applications. Clearly, any reduction in the time required to install the necessary support has a direct impact on the overall cycle time, and consequently the overall productivity and efficiency of the operations. The fully mechanized bolting rig of today, incorporating all of the benefits of modern computer technology, constitutes a major leap towards improved productivity, safety and operator environment.

**Hans Fernberg and Patrik Ericsson**

### Cabletec main technical data

Length:	13.9 m
Width:	2.7 m
Height:	3.3 m
Turning radius:	4.3m / 7.5 m

# Mining in steep orebodies

## Based on gravity

The different mining methods can be divided into two groups based on the dip of the orebody. Where the dip exceeds 50 degrees, blasted material will gravitate to a collection level where loading and main haulage are carried out. The dimensions of mineral deposits vary greatly, from massive formations stretching over several square kilometres, to half metre-wide quartz veins containing some 20 g/t gold. In recovering the minerals, the miners attempt to leave hangingwall and footwall waste rock intact. In the larger deposits, the drift size does not normally restrict the size of equipment. When the mineralization narrows to a few metres only, it can become self-defeating to excavate space for standard machines, because of dilution. For such situations, a selection of slim machines is available from Atlas Copco, capable of mechanized mining in drifts from 2 m-wide. These include a face drilling jumbo for narrow drifting, a similar longhole drilling rig, and a 2 cu m loader.

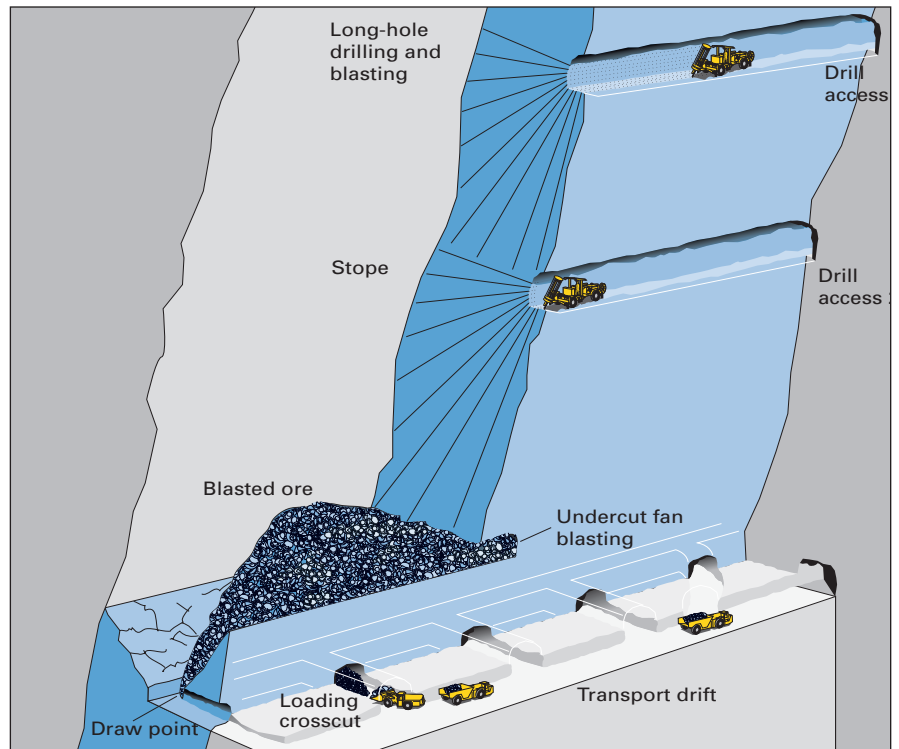

*Sublevel open stoping layout.*

*Big-hole stoping layout.*

## Sublevel open stoping

Sublevel open stoping (SLOS) is used for mining mineral deposits with: steep dip where the footwall inclination exceeds the angle of repose; stable rock in both hanging wall and footwall; competent ore and host rock; and regular ore boundaries. SLOS recovers the ore in large open stopes, which are normally backfilled to enable recovery of pillars.

The orebody is divided into separate stopes, between which ore sections are set aside for pillars to support the roof and the hanging wall. Pillars are normally shaped as vertical beams, across the orebody. Horizontal sections of ore are also left as crown pillars.

Miners want the largest possible stopes, to obtain the highest mining efficiency, subject to the stability of the rock mass. This limits their design dimensions.

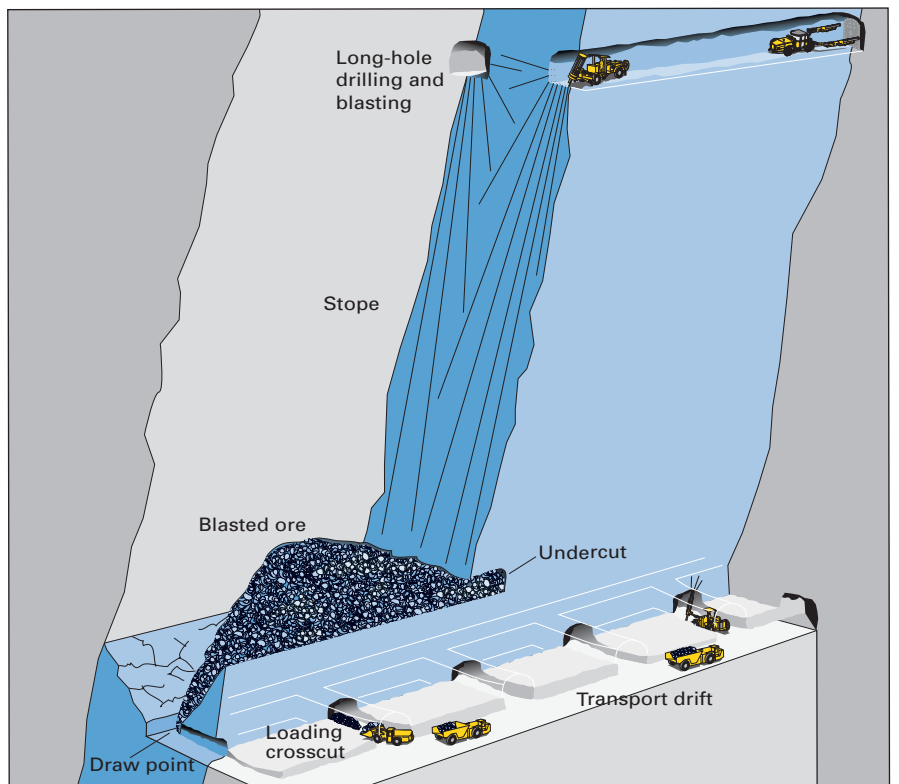

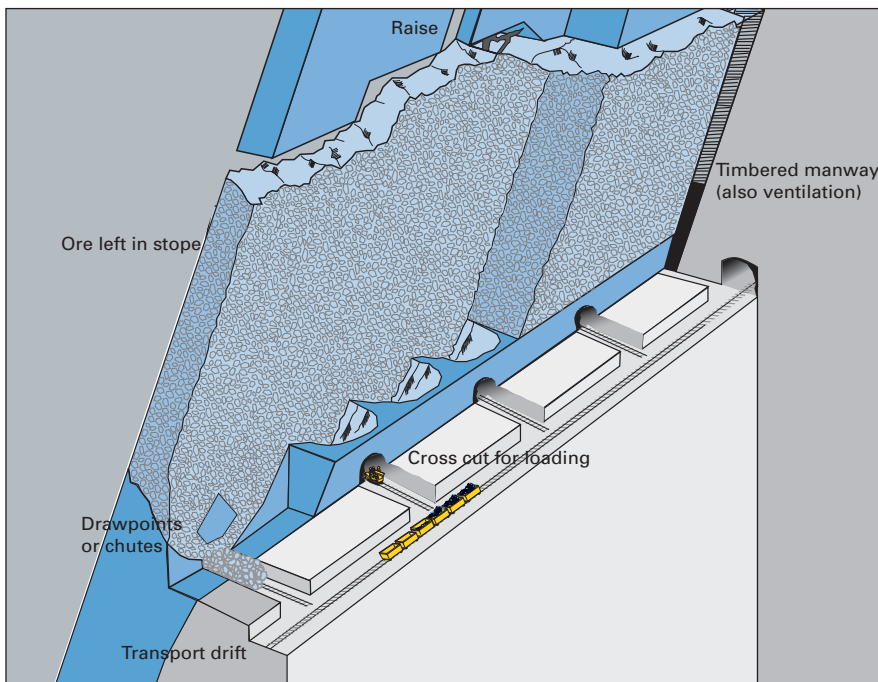

Shrinkage stoping layout.

Sublevel drifts are located within the orebody, between the main levels, for longhole drilling of blast patterns. The drill pattern accurately specifies where the blastholes are collared, and the depth and angle of each hole.

Drawpoints are located below the stope to enable safe mucking by LHD machines, which may tip into an adjacent orepass, or into trucks or rail cars. The trough-shaped stope bottom is typical, with loading drifts at regular

VCR primary stoping.

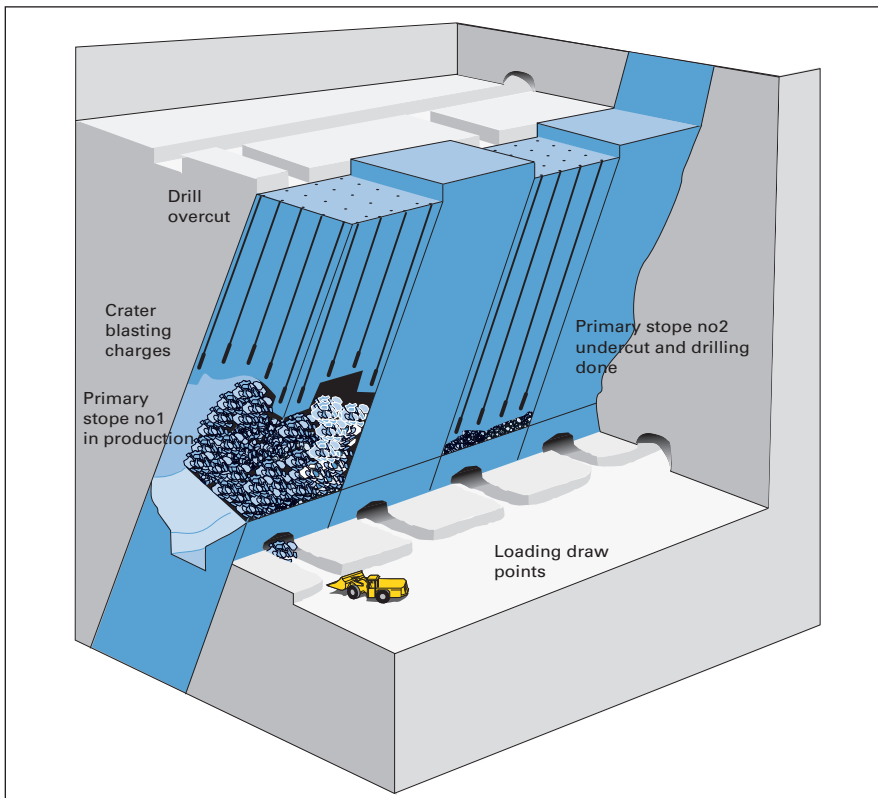

intervals. Nowadays, the loading level can be integrated with the undercut, and mucking out performed by a remote control LHD working in the open stope. This will reduce the amount of drift development in waste rock.

Sublevel stoping requires a straightforward shape of stopes and ore boundaries, within which only ore is drilled. In larger orebodies, modules of ore may be mined along strike, as primary and secondary stopes.

### Bighole stoping

Bighole stoping is an up-scaled variant of sublevel open stoping, using longer, larger-diameter DTH blastholes, ranging from 140 to 165 mm. Blast patterns are similar to SLOS, but with holes up to 100 m-long. A pattern with 140 mm blastholes will break a rock slice 4 m-thick, with 6 m toe spacing. DTH drilling is more accurate than topammer drilling, allowing the vertical spacing between sublevels to be extended, from 40 m with SLOS mining, to 60 m with bighole stoping. However, the risk of damage to the rock structures has to be taken into account by the mine planners, as the larger holes contain more explosives.

### Shrinkage stoping

In shrinkage stoping, traditionally a common mining method, ore is excavated in horizontal slices, starting from the stope bottom and advancing upwards. Part of the blasted ore is left in the stope, to serve as a working platform, and to give support to the stope walls.

Blasting swells the ore by about 50%, which means that a substantial amount has to be left in the stope until mining has reached the top section, following which final extraction can take place. Shrinkage stoping can be used for orebodies with: steep dips; comparatively stable ore and sidewall characteristics; regular ore boundaries; and ore unaffected by storage (some sulphide ores oxidize, generating excessive heat). The development consists of: haulage drift and crosscuts for mucking at stope bottom; establishment of drawpoints and undercut; and a raise from the haulage level passing through the undercut to the

main level, providing access and ventilation to the working area.

Drilling and blasting are carried out as overhead stoping. The rough pile of blasted ore prevents the usage of mechanized equipment, making the method labour-intensive. As such, working conditions are hazardous, and a large part of the ore has to be stored until final extraction. Despite these drawbacks, shrinkage stoping is still used, especially for small-scale operations.

## Vertical crater retreat

Vertical Crater Retreat (VCR) applies to orebodies with steep dip and competent rock in both ore and host rock. Part of the blasted ore will remain in the stope over the production cycle, serving as temporary support. This mechanized method can be regarded as a considerably safer form of shrinkage stoping, as no men have to work inside the stope.

VCR was originally developed by the Canadian mining company INCO, and uses the crater blasting technique of powerful explosives in large diameter holes. Concentrated spherical charges are used to excavate the ore in horizontal slices, from the stope bottom upwards. The ore gravitates to the stope bottom draw points, and is removed by loaders. Each stope is cleaned out before backfilling with cemented hydraulic fill.

Development for VCR stoping consists of: a haulage drift along the orebody at the drawpoint level; a drawpoint loading arrangement underneath the stope; an undercut; and an overcut access for drilling and charging.

The ore in a stope block is drilled from the overcut excavation using DTH rigs. Holes, mainly vertical, are drilled downward, breaking through into the undercut. Hole diameters vary from 140 to 165 mm, commonly spaced on a 4 m x 4 m grid.

From the overcut, powerful spherical charges are positioned by skilled crew in the lower section of the blast hole, at specified distances from the stope roof. The hole depth is measured, and it is stemmed at the correct height. Explosive charges are lowered down each hole and stemmed, usually to blast a 3 m slice of ore, which falls into the space below.

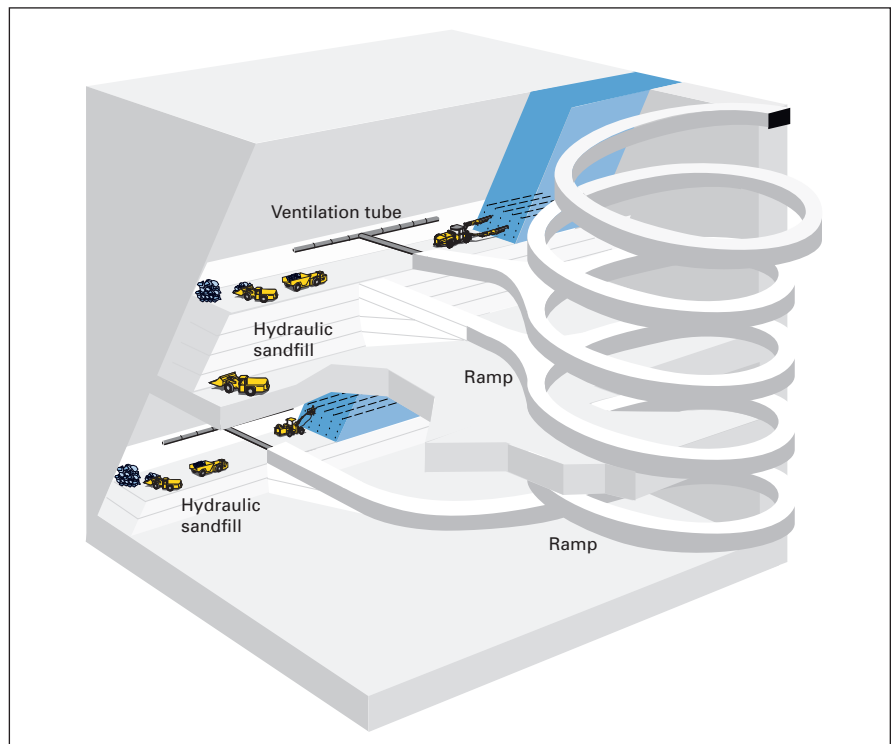

*Cut-and-fill stope layout.*

VCR charging is complex, and its techniques have to be mastered in order to avoid damaging the surrounding rock.

## Cut and fill mining

Cut-and-fill mining is applied to mining steeply dipping orebodies, in strata with good to moderate stability, and a comparatively high-grade mineralization.

It provides better selectivity than SLOS and VCR mining, and is preferred for orebodies with irregular shape and scattered mineralization, where high grade sections can be mined separately, and low grade rock left in the stopes. However, men and machines are working within the stope, which detracts from the safety of the operation.

Cut-and-fill mining excavates the ore in horizontal slices, starting from a bottom undercut, advancing upward. The ore is drilled, blasted, loaded and removed from the stope, which is then backfilled with deslimed sand tailings from the dressing plant, or waste rock carried in by LHD from development drives. The fill serves both to support stope walls, and as a working platform when mining the next slice.

Before filling, stope entries are barricaded and drainage tubes installed.

The stope is then filled with sand to almost full height, and cement is mixed into the final pours, to provide a solid floor for mobile machines to operate. As no rib pillars are left, and the crown pillar is commonly taken out in a single large blast once sufficient expansion room is available, most of the ore can be recovered with a minimum of waste dilution.

Development for cut-and-fill mining includes: a footwall haulage drive along the orebody at the main level; an undercut of the stope area, with drains for water; a spiral ramp in the footwall, with access drive to the undercut; and a raise connection to the level above, for ventilation and filling material.

The stope face appears as a wall, with an open slot at the bottom, above the fill. Breasting holes are drilled by a rig, charged and blasted, with the slot underneath providing swell space for the blasted rock.

The mineralization shows in the stope face, where it can be inspected by geologists. The drill pattern can be modified, to follow variations in ore boundaries. Sections with low grade can be left in place, or deposited in adjacent mined-out stope sections. Mining can divert from planned stope boundaries, and

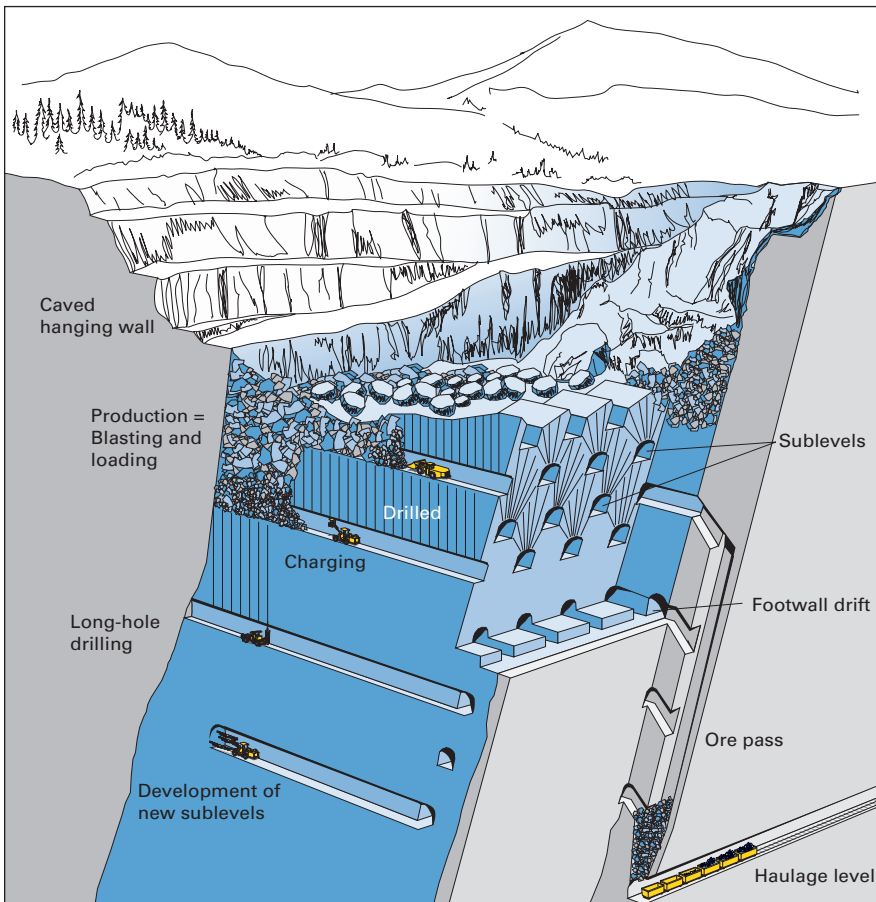

Sublevel caving layout.

recover enclosures of mineral from the host rock. The smooth fill surface and controlled fragmentation are ideal for LHD loaders, the standard vehicle for mucking and transport in cut-and-fill mines. Trimming distances from stope to orepass, located strategically for the ramps, must be within convenient range. Alternatively, the orepasses may be constructed inside the stope using steel lining segments installed in advance of each sand layer. To increase productivity

and safety, there is a trend towards replacing cut and fill mining with bench stoping and fill, as at Mt Isa, Australia, and towards open stoping with paste fill, as at Garpenberg, Sweden.

### Sublevel caving

Sublevel caving (SLC) adapts to large orebodies, with steep dip and continuity at depth. Sublevel footwall drifts have to be stable, requiring occasional rockbolting

only. The hangingwall has to fracture and collapse, following the cave, and subsidence of the ground surface above the orebody has to be tolerated.

Caving requires a rock mass where both orebody and host rock fracture under controlled conditions. As the mining removes rock without backfilling, the hanging wall carries on caving into the voids. Continued mining results in subsidence of the surface, where sinkholes may appear. Continuous caving is important, to avoid creation of cavities inside rock, where a sudden collapse could induce an inrush.

SLC extracts the ore through sublevels, which are developed in the orebody at regular vertical spacing. Each sublevel features a systematic layout with parallel drifts, along or across the orebody. In wide orebodies, sublevel drifts start from the footwall drive, and continue across to the hanging wall. In narrow orebodies, sublevel drifts branch off longitudinally in both directions from a central crosscut drive.

Development to prepare SLC stopes is extensive, and mainly involves driving multiple headings to prepare sublevels. A ramp connection is needed to connect different sublevels, and to communicate with main transport routes. Orepasses are also required, at strategic locations along sublevels, connecting to the main haulage level.

A section through the sublevel area will show drifts spread across the orebody, in a regular pattern, both in vertical and horizontal projections. The diamond shaped area, which can be traced above each drift, delineates the ore volume to be recovered from that drift.

Longhole rigs drill the ore section above the drift, in an upwards fanspread pattern, well ahead of production.

Blasting on each sublevel starts in sequence at the hanging wall, commonly using an upwards raise to provide initial expansion, and mining then retreats toward the footwall. Adjacent crosscuts are mined at a similar pace, with upper sublevels maintained ahead of lower sublevels, to preserve the cave and avoid undermining. Each longhole fan is blasted separately, and the ore fills the drawpoint. Mucking out by LHD continues until the waste dilution reaches the set limit. See the figure showing ore/

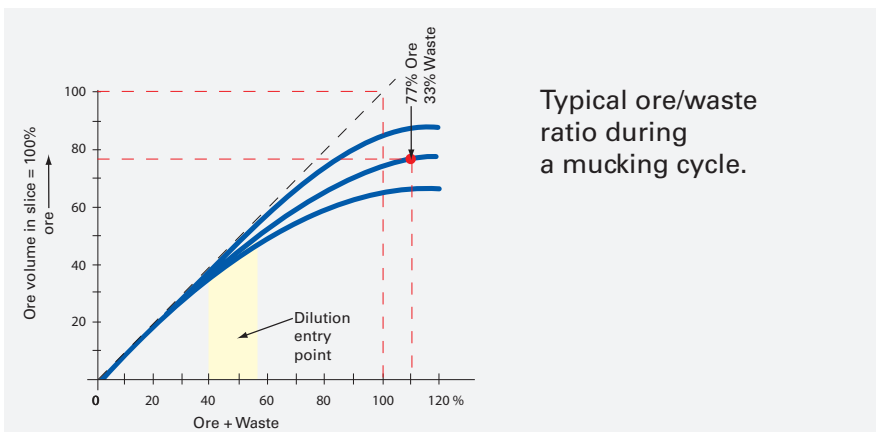



waste ratio during a typical mucking cycle. The LHD then moves to a freshly blasted crosscut, while the charging team prepares the next fan for blasting.

Sublevels are designed with tramming distances matched to particular sizes of LHD loaders. Mucking out is, like the other procedures in sublevel caving, very efficient, and the loader can be kept in continuous operation. Waste dilution in SLC varies between 15% and 40%, and ore losses may be 15% to 25%, depending on local conditions.

Dilution is of less influence for orebodies with diffuse boundaries, where the host rock contains low-grade minerals. Similar rules apply to magnetite ores, which are upgraded by simple magnetic separators. Sulphide ores, however, are refined by costly flotation processes, so dilution has to be closely controlled.

SLC is schematic, and repetitive, both in layout and working procedures. Development drifting, production drilling and mucking out are all carried out separately, with work taking place at different levels simultaneously.

There is always a place for the machines to work, which integrates mechanization into efficient ore production. Consequently, the SLC method is well suited for a high degree of automation and remote operations, with corresponding high productivity. Drawbacks are high waste dilution and substantial ore losses.

The Swedish iron ore producer LKAB is one of the world's leading producers of upgraded iron ore products. Vast experience and successful progress have been accumulated at their two large underground mines at Kiruna and Malmberget in northern Sweden by adopting SLC as the predominant mining method.

The articles in the book *Underground Mining Methods*, edited by William A. Hustrulid and Richard L. Bullock, chapters 43, 46 and 47 give valuable in-depth information about the operations and the caving parameters, both in general and at LKAB in particular.

## Block caving

Block-caving is a large scale production mining method applicable to low grade,

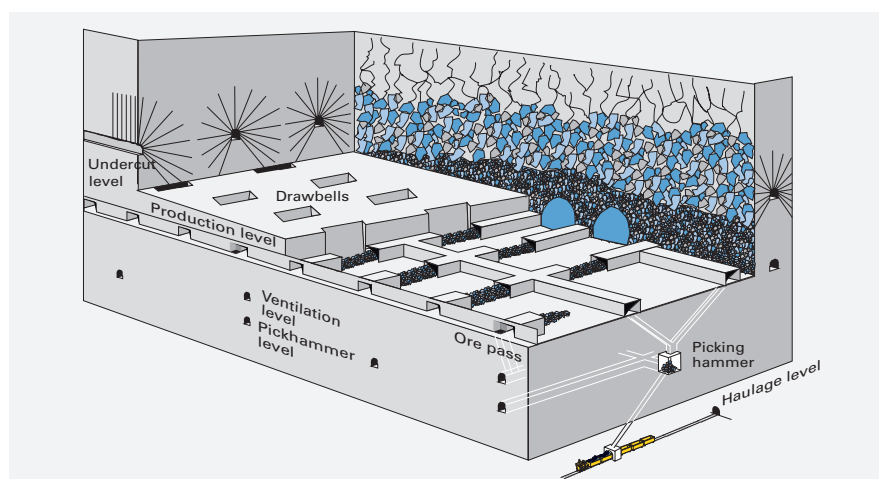

*Block caving layout.*

massive orebodies with: large dimensions both vertically and horizontally; a rock mass that behaves properly, breaking into blocks of manageable size; and a ground surface which is allowed to subside.

These rather unique conditions limit block-caving applications to special mineral deposits such as iron ore, low-grade copper and molybdenum mineralizations, and diamond-bearing kimberlite pipes.

Block caving is based on gravity combined with internal rock stresses, to fracture and break the rock mass. The drilling and blasting required for ore production is minimal, while development volume is huge. Blocks of orebody may have areas of several thousands of square metres, and development may have to start as much as 10 years in advance of production.

Caving is induced by undercutting the block by blasting, destroying its ability to support the overlying rock. Gravity forces, in the order of millions of tonnes, act to fracture the block. Continued pressure breaks the rock into smaller pieces to pass the drawpoints, where the ore is handled by LHD loaders or trains. As fragmentation without drilling and blasting is uneven, a substantial amount of secondary blasting and breaking can be expected at the drawpoints.

Development for block caving applying conventional gravity flow requires an undercut, where the rock mass underneath the block is fractured by longhole blasting. Drawbells with finger raises are excavated beneath the

undercut, to gather broken rock to the grizzly level, where oversize boulders are caught and then broken by blasting or hydraulic hammer. A lower set of finger raises channels ore from the grizzlies to chutes for train loading on the main level.

The intention is to maintain a steady draw from each block, and records are kept of volumes extracted from individual drawpoints. It is often necessary to assist the rock mass fracturing by longhole drilling and blasting in widely spaced patterns.

Drifts and other openings in the block caving area are excavated with minimum cross sections for man-entry. Still, heavy concrete lining and extensive rock bolting is necessary, to secure the integrity of mine drifts and drawpoint openings. Where LHD loaders are used in the drawpoints, a ventilation level is added into development plans.

Where the ore block breaks up successfully, and the extraction is carried out evenly from all of the drawpoints, block caving becomes a low-cost, high-productivity method, with good ore recovery and moderate inflow of waste dilutions. The risks are high, but the result can be extremely favourable. This method is often used when converting an open pit operation into an underground mine where surface production can continue while the underground infrastructure is prepared.

**Hans Fernberg**

# Mining in flat orebodies

## Nearly horizontal extraction

Variations on room-and-pillar and longwall mining techniques have always been attractive propositions for mechanization, because of the near horizontality of such systems. Until recently, trackless equipment was limited to a minimum working headroom of 2 m or more. However, major developments in Polish copper mines and in gold and platinum mines in South Africa have spawned a new generation of thin-seam and narrow mining equipment from Atlas Copco that can work in substantially less space than previously thought possible. The Rocket Boomer S1 L, for instance, has a tramping height of just 1.3 m, yet can cover a face area of up to 29 sq m. Likewise, the Scooptram ST 600LP loader equipped with video cameras to assist the driver has a height of only 1.56 m, but still carries a 6 t payload. Availability of such machines is already revolutionizing the design approach to mining flat orebodies.

## Room and pillar

Room and pillar is designed for mining of flat, bedded deposits of limited thickness. Examples are sedimentary deposits, like copper shale, limestone or sandstone containing lead, coal seams, salt and potash layers, limestone and dolomite.

The method recovers the mineralization in open stopes, leaving pillars of ore to support the roof. To recover the maximum amount of ore, miners aim to leave smallest possible pillars behind, because these are difficult and expensive to recover. The roof must remain intact, and rockbolts are used extensively as rock reinforcement. Rooms and pillars are normally arranged in regular patterns, and can be designed with circular pillars, square pillars, or elongated walls separating the rooms.

Classic room and pillar applies to flat, bedded deposits with moderate to

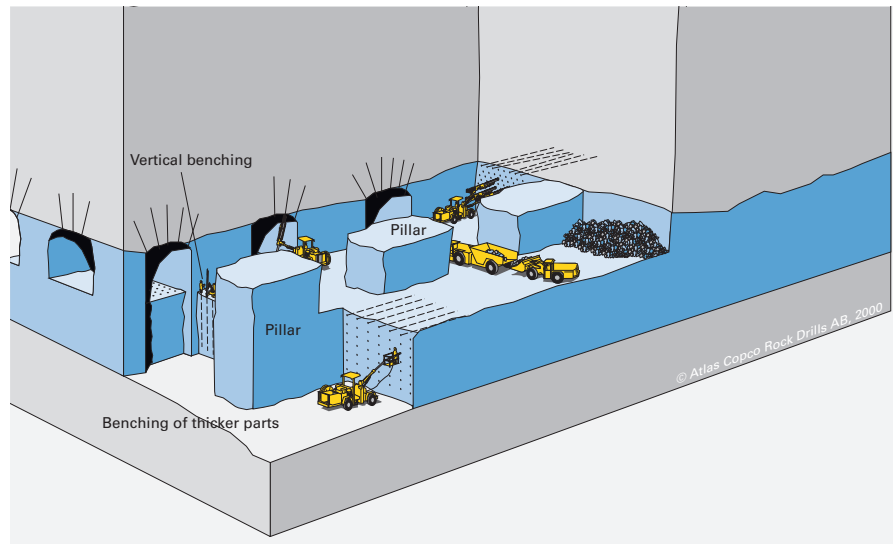

Classic room and pillar layout.

large thickness, also to inclined deposits with larger thickness. Mining the orebody creates large openings, where trackless machines can travel on the flat floor. Orebodies with large vertical height are mined in horizontal slices, starting at the top and benching down in steps.

Post room and pillar applies to inclined orebodies, of dip angle from 20 to 55 degrees, with large vertical height, where mined out space is backfilled. The fill keeps the rock mass stable, and serves as the work platform while mining the next ore slice.

Step room and pillar is an adaptation of trackless mining to orebodies with too steep a dip for rubber-tired vehicles to operate in a regular room and pillar layout. Haulage drifts and stopes are therefore angled diagonally across the dip, to create work areas with level floors off which trackless equipment can work. Mining advances downward, along the step room angle.

## Classic room and pillar

Very little development work is required to prepare flat-bedded deposits for room and pillar mining, because access for ore transport and communication is through the production rooms.

Ore production in flat room and pillar uses the same drill/blast techniques as in normal drifting. Where geological conditions are favourable, large-capacity drilling rigs and loaders can be used.

High orebodies are mined in slices, starting at the top, rockbolting the roof from each bench. Standard crawler rigs are used for drilling vertical holes and conventional bench blasting. Horizontal drilling and flat benching is a more practical alternative, using the same drilling equipment.

The blasted ore is loaded using diesel or cable-electric LHD machines, and, where height permits, dump trucks may be used between stope and dump. In thin orebodies, loading points may be necessary for transferring ore from loader to hauler. As all activities are carried out on one or very few levels covering a large area, there are many faces available at any time, so high equipment utilization is possible.

## Post pillar

Post pillar mining is a crossbreed of room and pillar and cut and fill mining. Post pillar mining recovers the mineralization in horizontal slices, starting from a bottom slice, advancing upwards. Pillars are left inside the stope to support the

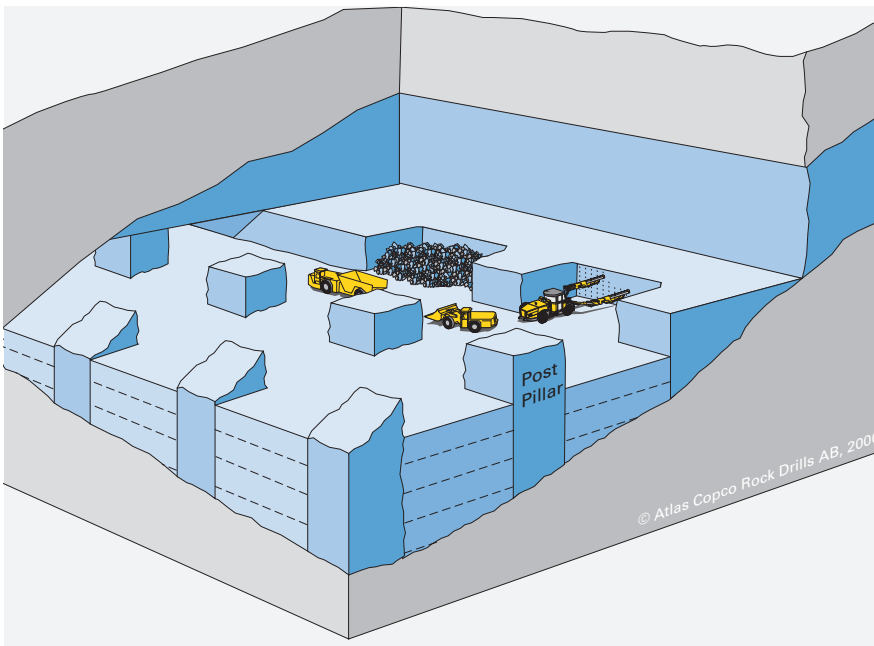

Post pillar mining layout.

roof. Mined-out stopes are backfilled with hydraulic tailings, which might contain cement for added strength, to allow the next slice to be mined working on the fill surface. Pillars are extended through several layers of fill, so that the material contributes to the support, permitting a high recovery rate. The fill allows the stope layout to be modified

to suit variations in rock conditions and ore boundaries.

Post pillar combines the advantages of flat-floor cut and fill, with the spacious stopes of room and pillar, while easy access to multiple production points favours efficient mechanization. Similar to cut and fill mining, cable bolting is commonly carried out to provide safe

Step room and pillar layout.

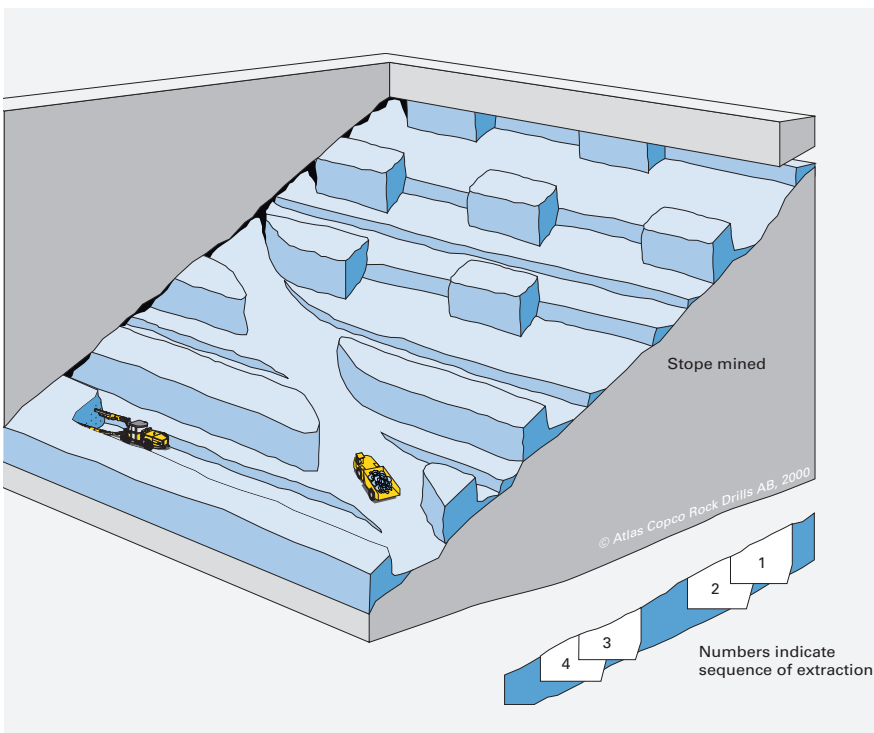

reinforcement of the roof several slices ahead of the current mining.

## Step room and pillar

Step room and pillar mining adapts the inclined orebody footwall for efficient use of trackless equipment in tabular deposits with thickness from 2 m to 5 m and dip ranging from 15 to 30 degrees. Stopes and haulageways cross the dip of the orebody in a polar coordinate system, orienting the stopes at angles across the dip that can comfortably be travelled by trackless vehicles. Parallel transport routes cross the orebody to establish roadway access to stopes and for trucking blasted ore to the shaft.

Stopes are attacked from the transport drifts, branching out at the pre-determined step-room angle. The stope is advanced forward, in a mode similar to drifting, until breakthrough into the next parallel transport drive. Next step is excavation of a similar drift, or side slash, one step down dip, adjacent to the first drive. This procedure is repeated until the full roof span is achieved, and an elongated pillar is left parallel with the stopes. The next stope is attacked in the same way, and mining continues downwards, step by step.

## Longwall mining

Longwall mining applies to thin, bedded deposits, with uniform thickness and large horizontal extension. Typical deposits are coal seams, potash layers or conglomerates, and gold reefs.

Longwall mining extracts the ore along a straight front, with large longitudinal extension. The mining area close to the face is kept open, to provide space for personnel and mining equipment. The roof may be allowed to subside at some distance behind the working face.

Development involves excavation of a network of haulage drifts, for access to production areas and transport of ore to shaft stations. As the mineralization extends over a large area, haulage drifts are paralleled by return airways, for ventilation of the workings. Haulage drifts are usually arranged in regular patterns, and excavated inside the ore. Coal and gold longwall production techniques are similar in principle, but quite different

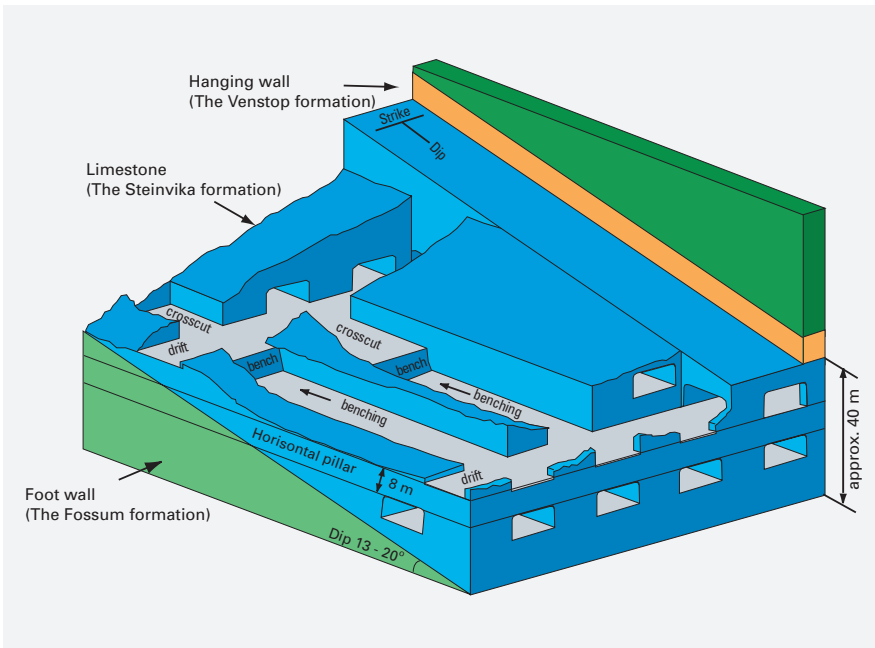

Room and pillar with benching at Dalen mine, Norway.

in terms of mechanization. In the coal mine, shearers shuttle back and forth along the face, cutting coal and depositing it on chain conveyors. The gold reef conglomerate is much harder, and difficult to tackle. South Africa gold mines have developed their own techniques, using handheld pneumatic rock drills in reefs

as thin as 1.0 m, which constitutes a great challenge for equipment manufacturers to mechanize. Pillars of timber or concrete are installed to support the roof in the very deep mines.

**Hans Fernberg**

Typical longwall layout.

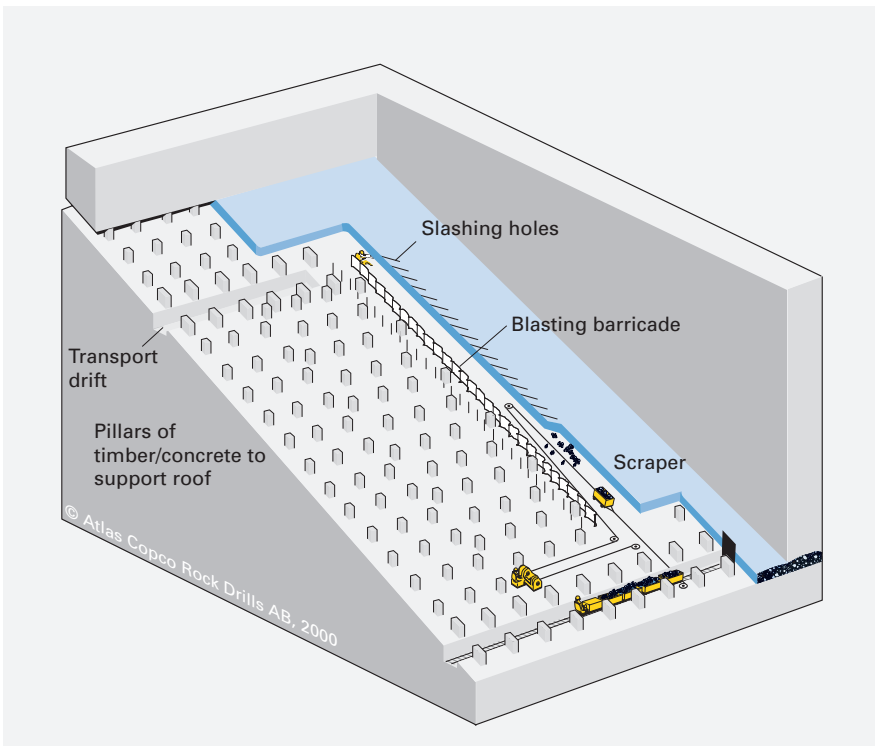

**Complete package**

Atlas Copco offers three key mining tools to provide the total solution for low seam mining applications: drill rigs, loaders and bolting rigs. These are all compact and technically advanced low profile versions, specially designed for efficient production in rigorous underground locations: the Rocket Boomer S1 L face drilling rig is adapted to this specific type of mining, with a coverage area between 6 and 29 sq m in a tramming height as low as 1.3 m; the Boltec SL bolting rig carrier, boom and bolting unit have been designed for efficient operation in roof heights between 1.8 and 2.5 m; and the Scooptram ST600LP can operate safely in 1.8 m headroom as one of a range of loaders of various capacities.



Rocket Boomer S1 L, the cabin version.



Rocket Boomer S1 L, the rear view.



Scooptram ST600LP.

# Backfilling for safety and profit

## Permanent support

Empty stopes are frequently backfilled as a means of providing support for future mining. Other than its own body weight, backfill is a passive support system that has to be compressed before exerting a restraining force. Backfill material is normally generated by the mine as waste rock underground, or as tailings from the surface concentrator, so backfilling may serve a secondary purpose as a means of disposal of otherwise useless byproducts. The optimum backfill method is clearly related to the mining method. Costs of backfill typically range between 10-20% of mine operating cost, of which cement represents up to 75%. Paste fill is gaining in popularity because it uses unclassified tailings and less water, but the capital cost of a paste fill plant is approximately twice the cost of a conventional hydraulic fill plant of the same capacity.

## Functions of backfill

The original function of backfill in hard rock mines was to support rock walls and pillars, and to provide a working surface for continuing mining. This was initially accomplished by rock fill, and more often in the present day by hydraulic fill.

If 3-4% of cement is added to a hydraulic backfill of concentrator tailings, and this is topped off in the stope with a 10% mix, a smooth and hard surface results. This is useful for mechanized removal of broken ore from the subsequent mining operation, and reduces dilution from the fill.

Backfill also affords the opportunity for more selective mining and better recovery of ore and pillars, thereby increasing both mine life and total return on investment.

Other functions of backfill are the prevention of subsidence, and better control over ventilation flow through

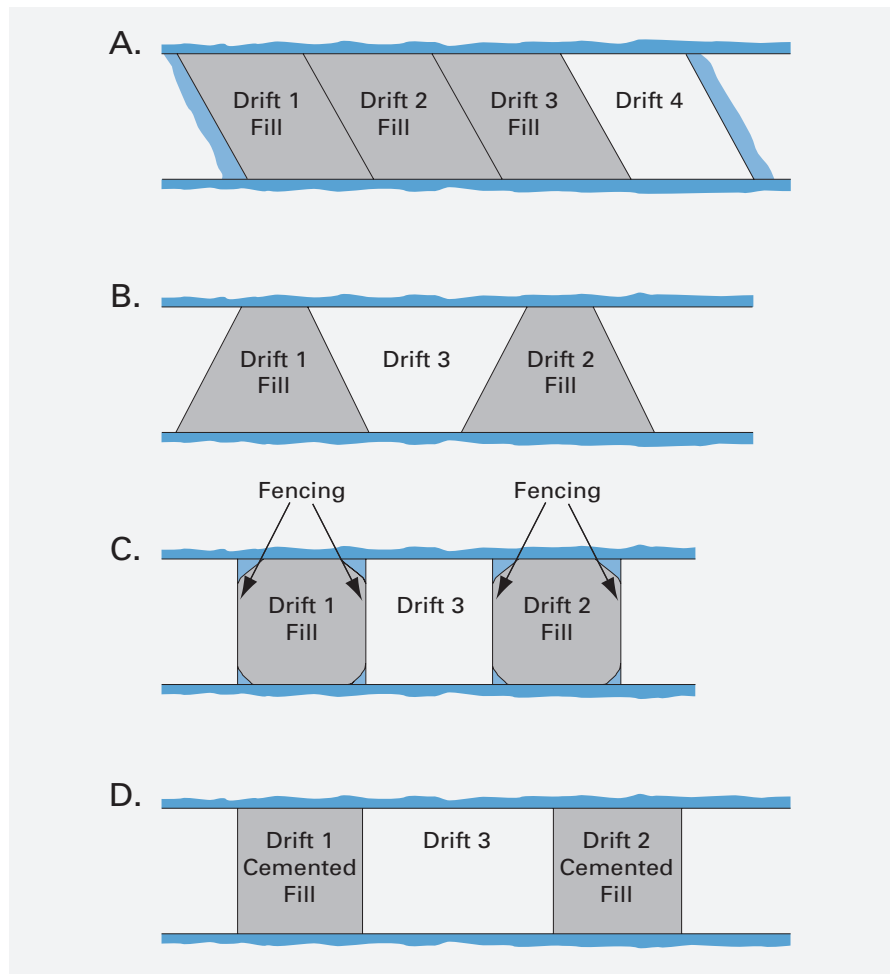

*Drift and fill mining sequence.*

the mine workings. Cemented hydraulic fill (CHF) or paste backfill may also be used to stabilize caved areas in the mine. Backfill is also considered an essential tool to help preserve the structural integrity of the mine workings as a whole, and to help avoid stressing ground to the point where rock bursts take place.

## Application and design

Fill preparation and placement systems should be simple and efficient, with special attention paid to quality control. Two systems are used: cyclic filling and delayed filling. In cyclic systems, the fill is placed in successive lifts, as in cut-and-fill mining sequences. The fill can form a platform for the operation

of mining equipment, or mining may be undertaken below, beside, or through the backfill.

In delayed backfill, the entire stope is filled in one operation. In this case, the fill must be able to stand as an unsupported wall rigid enough to withstand the effects of blasting. It should allow adjacent stopes to be extracted with minimal dilution from sloughing.

A whole host of factors have to be taken into consideration when designing a backfill regime. The geology and dimensions of the orebody and its dip and grade are important factors, as are the physical and mechanical properties of both the ore and its host rock. Environmental considerations, fill material resources, mining method, production capacity and operations schedules bear

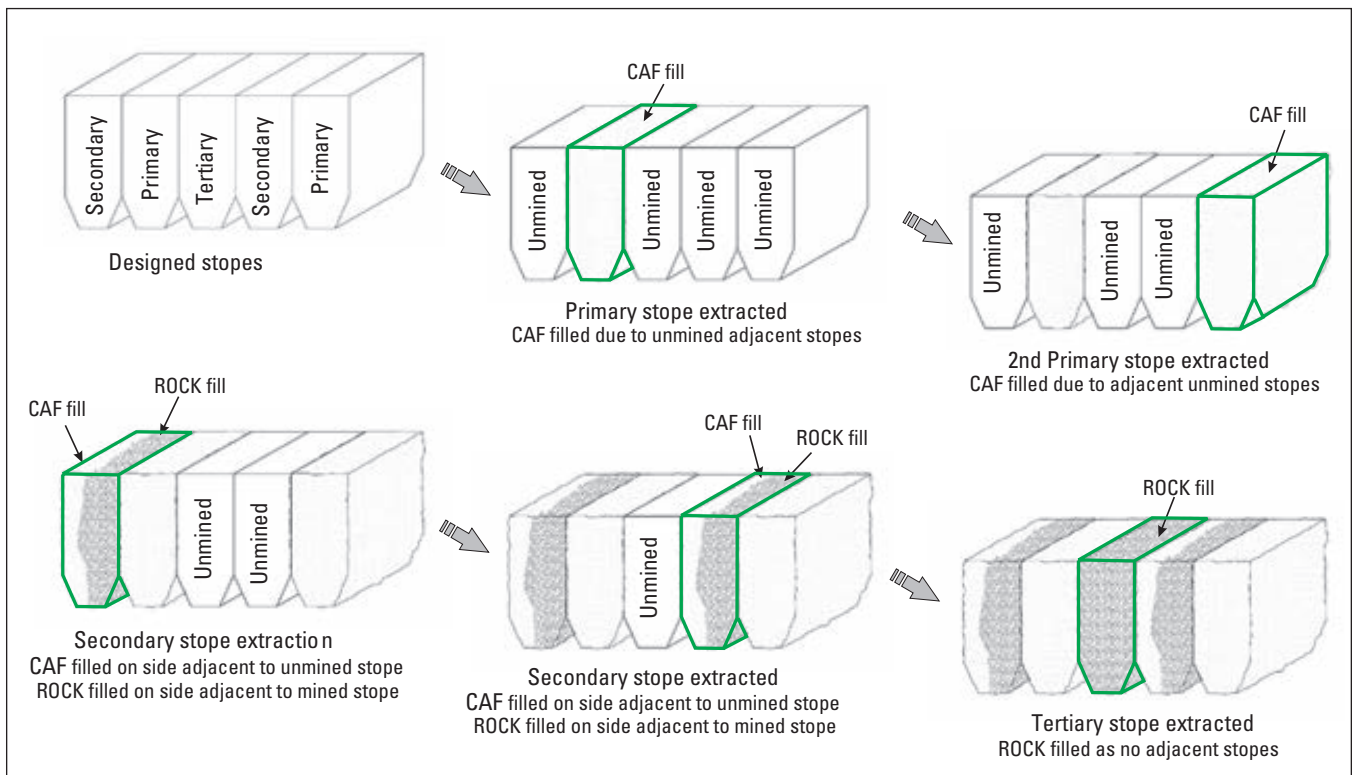

Stope extraction and filling sequence at Olympic Dam.

on the design, as do the fill mix and strength attainable using available materials. Fill quantities will determine the size of the preparation and placement systems, and the location and elevation of stope openings relative to surface facilities such as tailing dams and concentrator are major considerations. Mine planners focus on tailormade fill to save cement costs by strengthening the fill only where it is required, close to the stopes to be mined, such as at Olympic Dam.

### Hydraulic fill

Originally, backfill comprised waste rock, either from development or hand picked from broken ore. Some larger mines in the US quarried rock and gravitated it down fill raises to the mine workings.

Nowadays, rock fill is used for filling secondary and tertiary stopes, and is usually a convenient and economic means of disposal for waste from development.

The first hydraulic fills were composed of concentrator tailings that would otherwise have been deposited on the surface. The mill tailings were cycloned to remove slimes so that the contained water would decant.

This fill was transported underground as slurry, composed of around 55% solids, which is the typical underflow for thickeners and is the pulp density normally used for surface tailings lines.

When the grind from the mill was too fine for decanting in the stopes, alluvial sand was employed instead of tailings. Particles of alluvial sand are naturally rounded, enabling a higher content to be pumped than for hydraulic fill made from cycloned tailings. This type of fill is commonly referred to as sand fill. Many mines still employ non-cemented hydraulic fill, particularly for filling tertiary stopes.

The quantity of drain water from hydraulic backfill slurry containing 70% solids is only a quarter that resulting from a 55% solids mix.

The porosity of hydraulic backfill is nearly 50%. It may be walked upon just a few hours after placement, and will carry traffic within 24 hours.

Underhand cut and fill mining sequence.

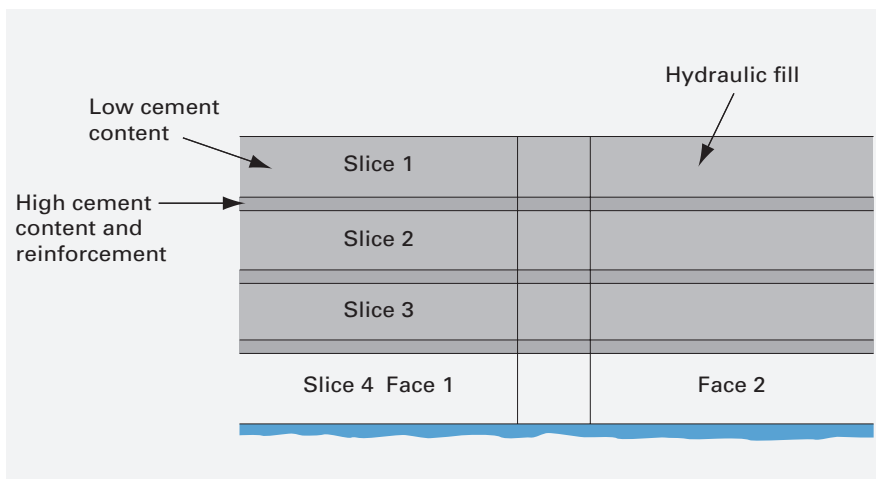

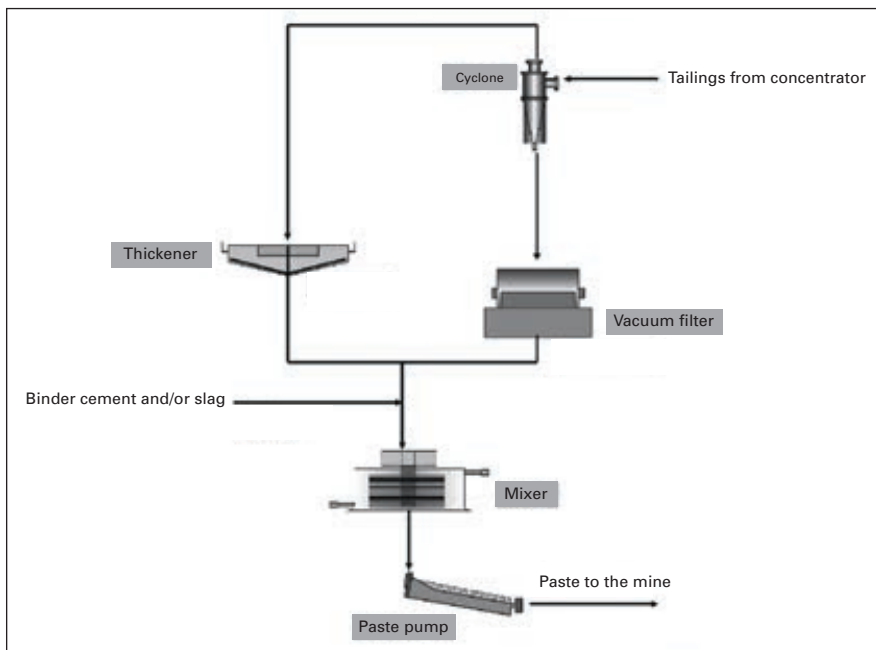

Paste factory – principal flowsheet.

## Planning considerations

Because the density of hydraulic fill is only about half that of ore, a supplementary fill material will be needed when less than half of the tailings can be recovered from the mill circuit.

When planning a hydraulic fill system, a major consideration is water drainage, collection and disposal, particularly on deep mines. Getting large volumes of water back to surface can be a costly exercise, and installing the infrastructure may be difficult, expensive and time consuming.

Portland cement added to hydraulic fill as a binder also adds strength, and this system of fill in normal and high density is employed at many mines around the world. A portion of the cement may be substituted using fly ash, ground slag, lime or anhydrite.

If cement is added in the ratio 1:30, the backfill provides better support for pillars and rock walls. If the top layer is then enriched at 1:10, the backfill provides a smooth and hard surface from which broken ore can be loaded and removed. Addition of cement reduces ore dilution from the fill and facilitates selective mining and greater recovery from both stopes and pillars.

Water decanted from cemented fill has to be handled appropriately to avoid cement particles reaching the ore passes

and sumps, where they can have great nuisance value. One approach is to reduce the amount of water in the fill, increasing solids content to 65-75% and more in a high-density fill. Additives can also reduce the water decant from fill.

## Paste fill

Paste fill originally used non-cycloned mill tailings mixed with cement at the stope. Coarse tailings permit a very high solids content of up to 88% to be pumped at high pressure, and high setting strengths were achieved. Paste is currently used as a replacement for hydraulic fill, with the cement added at surface. It exhibits the physical properties of a semi-solid when compared to high-density fill, which is a fluid.

Because the slimes fraction of the tailings forms part of the mix, cement always needs to be added into paste fill, with 1.5% as the minimum requirement to prevent liquefaction. Very precise control of pulp density is required for gravity flow of paste fill, where a 1-2% increase can more than double pipeline pressures.

## Cemented rock fill

Cemented rock fill (CRF) originally consisted of spraying cement slurry or



Paste fill plant at Garpenberg, Sweden.

cemented hydraulic fill on top of stopes filled with waste rock, as practiced at Geco and Mount Isa mines. Nowadays, cement slurry is added to the waste rock before the stope is filled. Where rock is quarried on surface, it is normally gravitated to the mining horizon through a fill raise, from the base of which trucks or conveyors are used for lateral transport underground.

Advantages of CRF include a high strength to cement content ratio, and provision of a stiff fill that contributes to regional ground support. CRF is still selected for some new mines, and many operators prefer this system.

Cement rich hydraulic fill was once used for mats where poor ground conditions dictated underhand cut and fill mining. Since the major cost component of backfill is the cement at a ratio of 1:2, this fill is not economical, and was replaced with ready-mix concrete with 10-12% cement content for a standard 3,000 psi, or 20 Mpa, mix.

Ice fill has been used in Norway and Russia in permafrost regions.

**Hans Fernberg**

# Atlas Copco rock bolts for mining

Modern computer-based geotechnical monitoring techniques indicate that the greatest relaxation or movement of the rock mass occurs immediately following excavation. They confirm that, after a certain period, the rock will establish a new equilibrium based on its own inherent self-supporting capacity. The best quality rock will remain self-supporting for extensive periods of time without the need for extra support. As the rock quality declines, support requirements increase proportionally. The poorer the quality of the rock, the greater the degree of support required, and it becomes increasingly

crucial to install reinforcement as quickly and as close to the face as possible after excavation. Engineers involved in the design of rock reinforcement systems must satisfy ever increasing demands to optimize the design to gain maximum safety and economy. The primary objective in the design of the support system is to assist the rock mass to support itself. Accordingly, quality and time are the two main parameters which must be taken into account when determining the type of rockbolt to be used for rock reinforcement, in both mining and construction applications.

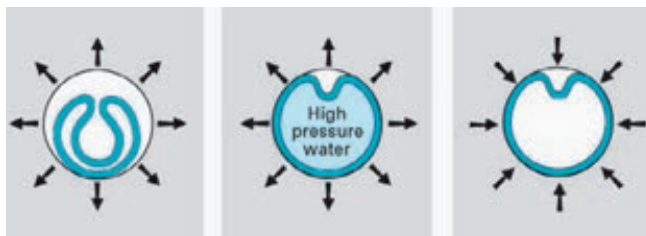
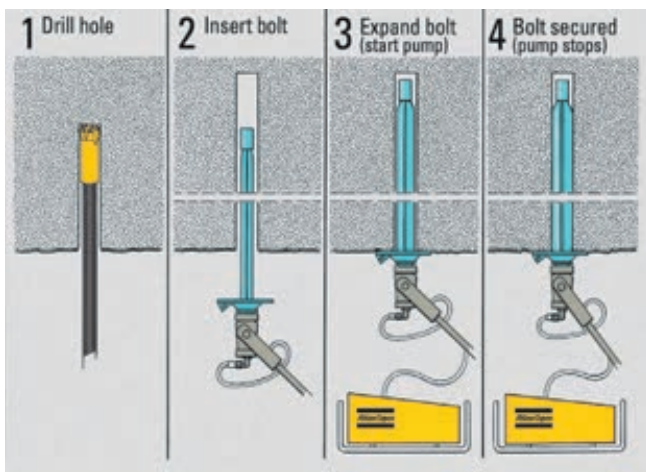

## Swellex

The Swellex concept entails that the rock is secured by immediate and full support action from the Swellex bolts. The moment the Swellex bolt is expanded in the hole, it interacts with the rock to maintain its integrity. The quality of the bolt installation is automatically confirmed when the pump stops, and is independent of rock mass conditions or operator experience. Controllability means safety! The Swellex rockbolts are designed to optimize the effectiveness of each bolt, so the bolting operation matches the required safety levels as planned by the engineers. See pictures to the left.

## Roofex

Roofex features a high quality steel bar inside a smooth plastic sheathing which is fixed inside the borehole with cement or resin grout. The bolt also has an energy absorber which functions as a sliding element over the steel bar. This allows the bolt to extend outwards during sudden displacements such as rock burst or seismic events while still providing constant load capacity. This capability makes the Roofex rock bolt especially suitable for developing new, deep underground excavations in poor quality rock or in areas where rock burst or seismic events are frequent. The bolt can be produced in standard lengths typically used in mining and tunnelling, and the displacement capacity can be pre-selected during manufacture. See picture below.

**Mathias Lewén**

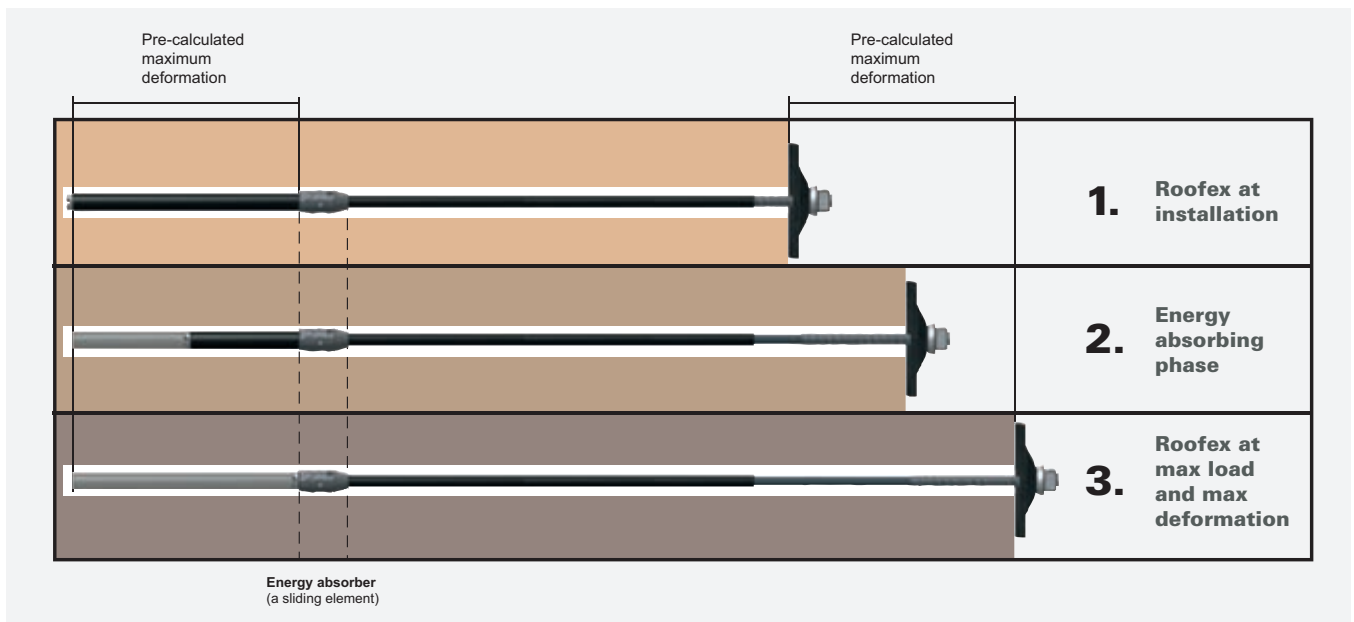





# Improving output at Garpenberg

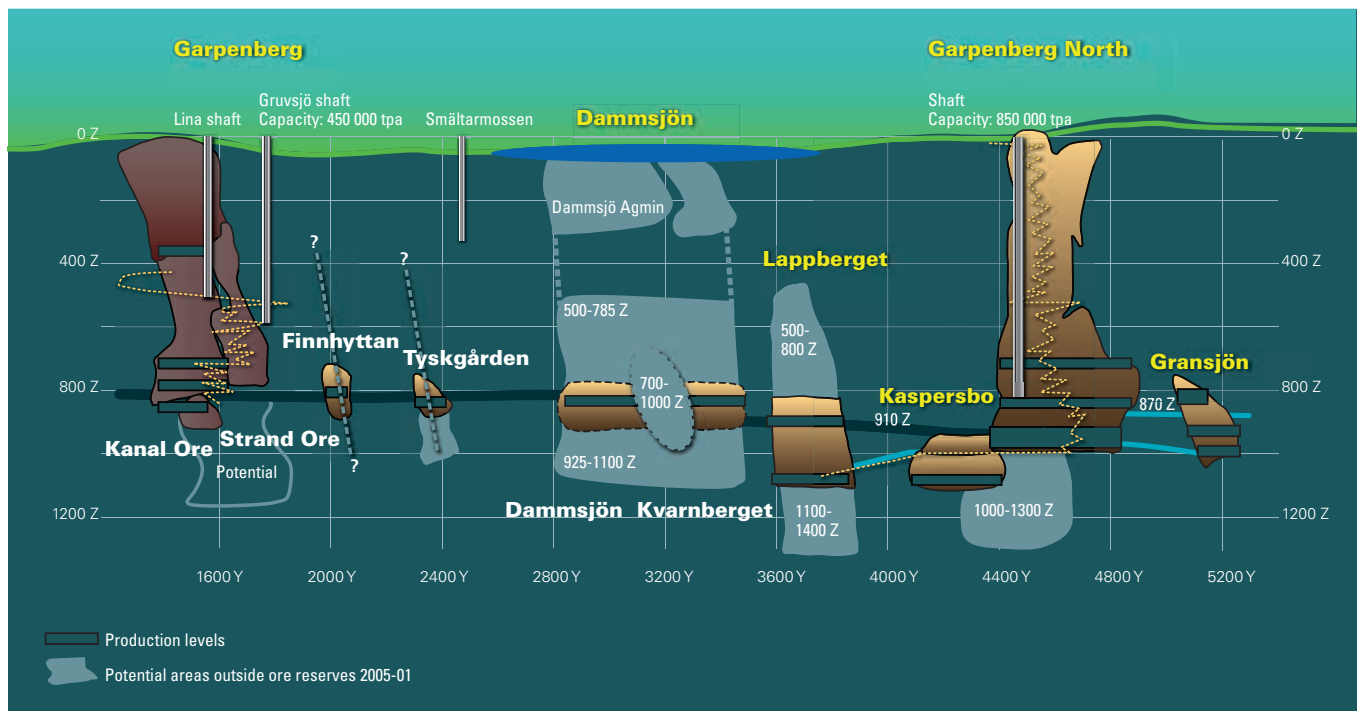

Idealized long section at Garpenberg showing all orebodies and shafts.

## One million tonnes of ore

The Garpenberg mine, located 200 km northwest of Stockholm, extracts more than 1 million t/y of ore. The ore is polymetallic and contains mainly zinc, silver and also some lead, copper and gold. Additionally, about 500,000 t of development waste is excavated annually. Over recent years, Garpenberg has been forced to add reserves, or reconsider its future. Happily, more orebodies have been discovered, and new stoping methods and drilling technology introduced. Atlas Copco has cooperated closely with Garpenberg management to resolve technical issues, designing and supplying equipment to suit the evolving objectives. As a result, the mine achieved over 1Mt of ore in 2005, at very acceptable grades.

## History

Mining has been conducted at Garpenberg since the 13th century. The present operations started in 1950-53, when AB Zinkgruvor developed a new main

shaft and concrete headframe and the adjacent concentrator. Boliden acquired the mine in 1957 and completed the development of a second shaft in 1972, accessing the 800 m level at Garpenberg North, having a hoisting capacity of 850,000 t/y and effectively creating a second and larger mine. Between these two shafts, the company located another orebody under a lake at Dammsjön and, in the 1980s, considered draining the lake in order to develop an open pit.

The mineralization in the Garpenberg area occurs in a long, narrow synclinal structure which is believed to be Middle Precambrian, but may have been remobilized later. The orebodies are vertically extensive lenses that are usually narrow, much folded and therefore twisting and irregular.

## Cut and fill

Until very recently all of the ore, subdivided in 100 m high slices, was extracted by cut-and-fill mining, taking 5-6 m thick slices drilled horizontally from 50-300 m long and up to 15 m

wide stopes. Rock fill was used in the bottom cut, and either plain sand or cemented hydraulic fill above. The sand comes from the coarse fraction of the mill tailings, and the fill is supplemented by development waste.

Mining starts normally at the centre of the base level of the stope and progresses towards the ends and upwards. The last cut, just below the crown pillar, is heavily reinforced to facilitate the recovery of the 8-15 m high pillar using up holes drilling and blasting.

The undercut-and-fill method, progressing downwards, was used in the Strandgruvan section from the mid-70s until 2001, when the ore was mined out. This method provided a safe working roof in the weak, fractured ore with unstable footwall, for just the extra cost of cement and rebar reinforcement. The method was suited to the orebody irregularities, and no crown pillar had to be left or recovered.

The introduction of trackless mining and further exploration of the mineralization in the North mine led to the progressive extension of a 1:7 ramp down



Simba M7 C production drill rig at Garpenberg.

to the 910 m level. In 1998-9, it was extended to the 1000 m level, increasing the overall length to 8.7 km.

To increase hoisting capacity at the Garpenberg mine, the new Gruvsjö production shaft was completed in 1997 and the original shaft was converted for personnel and materials hoisting. With a hoisting capacity of 450,000 t/y, the newer shaft connects with a ramp accessing the Kanal and Strand orebodies.

The present operating area extends approximately 4.5 km SW to NE from the original shaft to the Gransjön mining section.

## Concentrate production

Upgraded in the early 1990s, the concentrator yields separate zinc, lead, copper and precious metals concentrates. The zinc and lead concentrates are trucked to Gävle harbour and shipped either to Kokkola in Finland or Odda in Norway. Copper and precious metals concentrates are railed to the Rönnskär smelter in Sweden. Since 1957, Boliden has milled over 20 million tonnes of ore at Garpenberg.

While the new shaft raised hoisting capacity, and ramp extension accessed new ore in the North mine, metals pro-

duction rose to record levels in 1998. However, this improvement could not be maintained. Zinc concentrate output fell from 69,051 t in 1998 to 61,126 t in 2001, despite a rise in ore production. And proven plus probable ore reserves declined from 5.7 Mt in 1998 to 2.2 Mt at 4.0% Zn in 2003, putting a question mark on the future of the mine.

However, Boliden continued to make investments in technology for the long term at Garpenberg. The mine, the company and the market are now benefiting. And the geologists are very popular.

## New reserves

Probably the most significant event at Garpenberg during the period of decline was the discovery in 1998 of a new orebody between Garpenberg North and Dammsjön, named Lappberget. This encouraged the company to start development in 2000 of an approximately 3.0 km long drift to connect the 900 m level at Garpenberg North, first to Lappberget for exploration access, and thence to the ramp at the 800 m level at Garpenberg. During 2001, Boliden started core drilling at the 800 m and 1000 m levels in Lappberget, and by February, 2003 was able to start mining ore from the new

source. Zinc concentrate production in the year increased to 80,748 t.

In March, 2004 the connecting drift was completed, and the formerly separate mines have since been regarded and managed as a single operation. The drift allows access and infrastructure development of new mineable areas, and Garpenberg quickly boosted mine output. The main focus has been on Lappberget, including driving a ramp close to the orebody from the 350 m level, with connection to the surface scheduled for 2007. The Tyskgården mineralization, discovered in the early 1980s, also became accessible, and mining started there in 2003-4. In 2004 Boliden discovered an extension of the Dammsjön mineralization around the 800 m level, and during 2005 a new discovery was made, the reportedly large and potentially high-grade Kvarnberget deposit.

## Higher output

In 2005, the mine produced 1,102,000 t ore grading 5.75% Zn, 2.28% Pb, 0.09% Cu and 117 g/t Ag. Approximately 40% of the ore came from Lappberget. The mill yielded 101,000 t of 55.3% zinc concentrate; 29,000 t of 72% lead concentrate with 1,800 g/t silver; 2,800 t of 15% copper concentrate with 40,000 g/t; and 120 t of precious metal concentrate grading 65% lead, 40,000 g/t silver and 400 g/t gold. Some 967,000 t of tailings retained 0.34% Zn, 0.29% Pb, 0.02% Cu and 25.5 g/t Ag. By end-2005 Boliden employed 280 people at Garpenberg, with a further 70 working for contractors at the site.

The operation works around the clock 7 days/week in both the concentrator and the mine, with mining carried out by four production teams supported by a development crew and a charging crew. Garpenberg is the Hedemora Community's largest private sector employer.

Since the start of 2005 exploration has continued, not only adding tonnes, but also raising average grade. Thanks to the exploration effort, Garpenberg also started 2006 with proven reserves of 4.73 Mt grading 6.0% Zn, 2.5% Pb, 0.1% Cu, 99 g/t Ag and 0.3 g/t Au. Probable ore brought total reserves up to 10.67 Mt. That compares with 3.63 Mt of reserves at the beginning of 2005.



Total resources were also increased, from 11.08 Mt in January 2005 to 13.22 Mt. This should be sufficient to add another 15-20 years to mine life.

These quantities should increase further when portions of the orebodies at Kaspersbo (from 1,000 m down to 1,300 m), Lappberget (500–800 m and 1,100–1,400 m), Dammsjön (500–785 m and 925–1,100m), and a smaller section at Tyskgården are included in the reserves figures. Kvarnberget is yet to be added, and Boliden is also exploring to the north of the Gransjön where the property extends for several kilometres.

## Sublevel stoping at Lappberget

The geological and geotechnical characteristics of significant portions of the newly-discovered orebodies allow mining using more productive longhole methods instead of cut-and-fill. Lappberget ore, for instance, can be 60 m wide through considerable vertical distances, and has proved to be suitable for sublevel stoping using a system of primary and secondary stopes progressing upwards. Primary stopes are 15 m wide and 40 m high and filled with paste made from concentrator tailings mixed with about 5% cement. The 20 m wide secondary stopes are filled with development muck without cement. High precision drilling is necessary to get optimum ore recovery and fragmentation.

This mining method can possibly be used in parts of the Kaspersbo orebody, if rock quality is high enough. This will help with cost control, which is crucial for mining in Sweden. With Lappberget alone containing 5.46 Mt of the current reserves, grading over 7% zinc and 2.6% lead, plus silver and gold, it is no surprise that present development activities focus on using longhole-based production from these orebodies to raise total metal-in-concentrate output. Presently eight orebodies are being exploited.

Garpenberg has generated a strategic plan for 2006–2019 allocating SEK 1 billion for developing Lappberget. The overall programme includes: increasing concentrator capacity to 1.2 Mt/y; designing and building a paste fill production/distribution system; and starting longhole drilling. This latter project

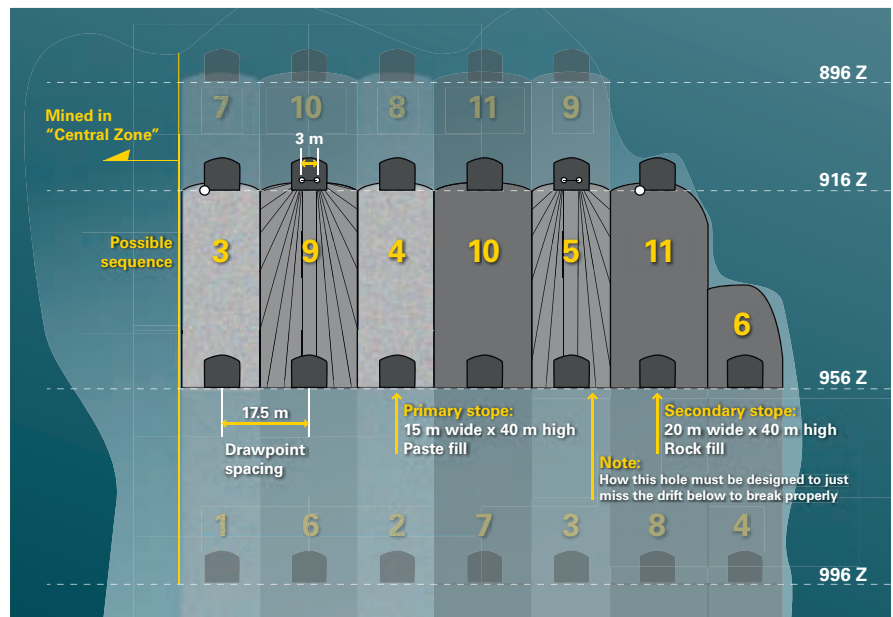

Sublevel stoping layout and mining sequence for Lappberget orebody.

involved rill mining in the Tyskgården orebody, followed by sublevel stoping in Lappberget.

## Rill mining

A special mining method known as rill mining has been developed for excavating the Tyskgården orebody. The orebody is relatively small and large quantities of development muck have to be accommodated underground as hoisting facilities are used for ore only.

The method can be described as a modified sublevel stoping with successive back fill as mining is progressing. The 10 m wide cut-off slots are drilled across the orebody using up-holes and

blasted in one single firing, starting from the centre. Seven 127 mm holes are left uncharged to provide sufficient expansion for the remaining 64 mm holes.

After the slot has been opened, 70 degrees up-holes fans consisting of eight, approximately 17 m long, holes are blasted into the void. Three rows having a total of 24 holes are blasted simultaneously. After mucking out each blast, new waste is discharged into the stope forming a 45 degrees rill down into the drawpoint. As the waste material will stay quite stable at 45 degrees rill angle, the risk of ore dilution is negligible.

The total mine output is restricted to the 1.2-1.3 Mt/y hoisting capacity available plus, with a limited amount of truck

Development and primary stoping layout 1080 level.

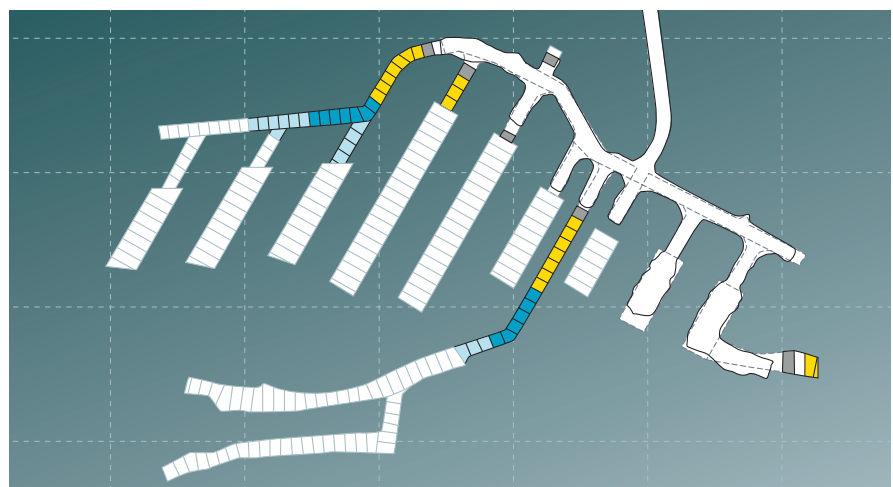

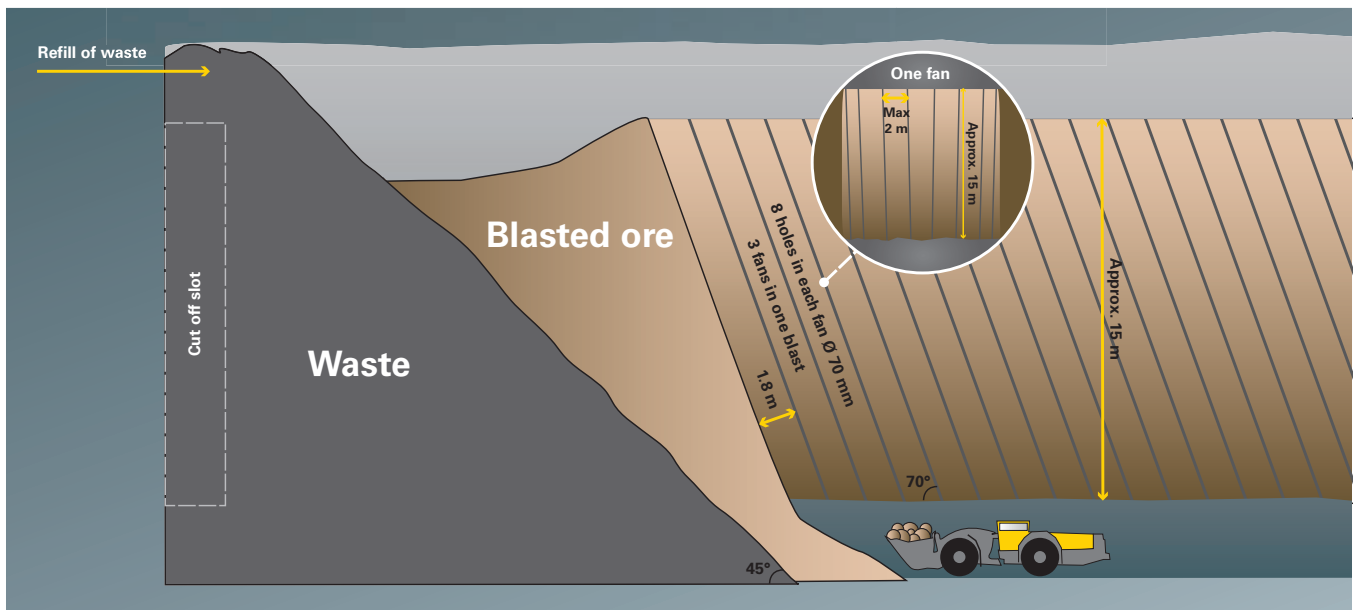

Rill mining in progress.

ore haulage to surface possible. And, although flotation capacity has been improved, concentrator throughput is now limited to the same sort of tonnage by grinding mill capacity. Assuming demand for Garpenberg concentrates increases in the near term, it will be necessary for New Boliden to decide whether to increase hoisting capacity. Developing the now-available reserves for higher long-term production using additional hoisting and processing capacity might double the amount of investment initially planned.

### New drilling technology

Atlas Copco has supplied drilling equipment to Boliden's underground mines for many years. Recently, the company

has worked particularly closely with Garpenberg on the development of computer-based technology for more precise drilling and blasting to enhance productivity and reduce ore dilution and operating costs.

This joint development process started with the 1998-1999 ramp extension at Garpenberg North. The complex geology results in winding cross sections of varying width, and ore boundaries which are difficult to predict by core drilling. To enable the drifts in the cut and fill stopes to follow the paths of the orebodies, accurate production maps and precise drill rig navigation are essential. Producing drill plans in the office is relatively easy. However, getting drill plans that match the actual ore boundaries is a challenge, and frequently the

driller is obliged to improvise while drilling, which can lead to poor blasting results.

### Drill plan generator

The drill plan generator overcomes the ore navigation problem by assisting the operator to create an optimum drill plan right at the face. In case the generated drill plan does not match the actual ore boundaries, the operator can define new coordinates to correct the situation. To do this, having aligned the feed to the laser beam to define the position of the rig, the operator points the drill feeds at the four corners of the face, in line with the geologist's marks.

When all adjustments have been made, the Rig Control System RCS will

Drill pattern for cut off slot.

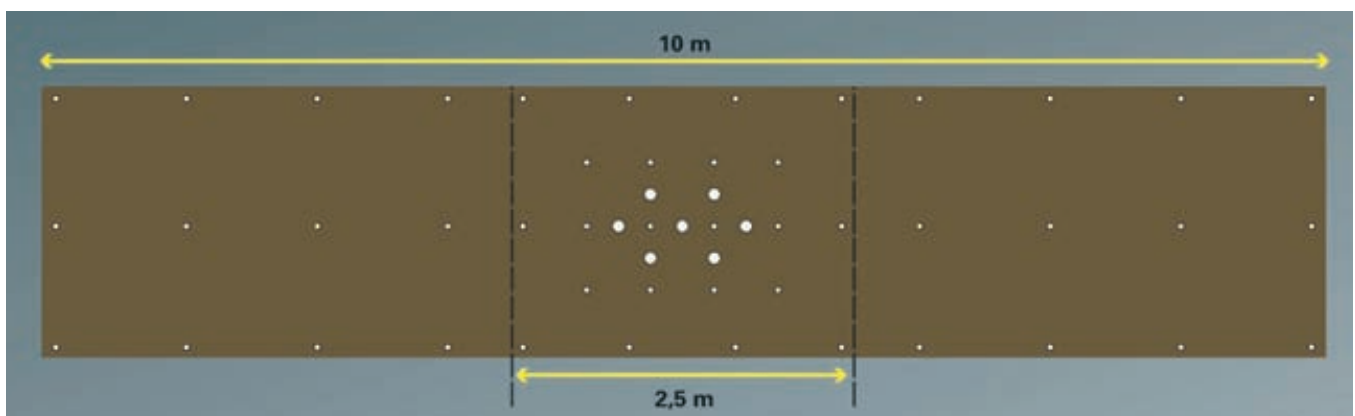



develop the most efficient round compatible with the new parameters. The generated drill plan is automatically entered into the Boomer L2 C ABC Regular standard drilling system, and the operator can start drilling. While drilling, each completed hole is logged, and, if the Measure While Drilling (MWD) option is activated, the drilling parameters along the hole are recorded. All of the data is logged on the PC card for off-line processing in the Tunnel Manager support program, and is then transferred to the mine database. As a result of the Drill Plan Generator and ABC Regular, Garpenberg North increased the size of the production rounds from 400 t to 600 t, reduced drilling time from 5 to 3 h/round, reducing costs of explosives, scaling and rock support and, most important, minimizing ore dilution. Garpenberg now has one Rocket Boomer L2 C30 rig with COP 3038 rock drills and one Rocket Boomer L2 C with the COP 1838, as well as the Rocket Boomer 352S.

## Mine navigation

The availability of orebodies at Garpenberg suitable for mining with longhole production drill rigs led to a further collaboration. Having already transferred RCS technology to the Simba longhole drill rigs, Atlas Copco provided the mine with a Simba M7 C that is additionally able to use new software for precision longhole drilling. This utilizes Garpenberg's mine coordinate reference, mapping and planning system in a similar way to the software developed for the Rocket Boomer L2 C units.

Using a PC card, the Mine Navigation package can effectively integrate the Simba RCS with the mine co-ordinate reference system, allowing the operator to position the machine at the correct vertical and horizontal coordinates in the drilling drift for drilling planned longhole fans in precisely the intended place. Using the drill plan supplied by Microsystem (or, in other mines, the Ore Manager package) to the Rig Control System, the operator can drill to the exact x, y and z positions prescribed for each hole bottom. Just as the Rocket Boomer rigs can use the MWD system while face drilling, so the Simba can

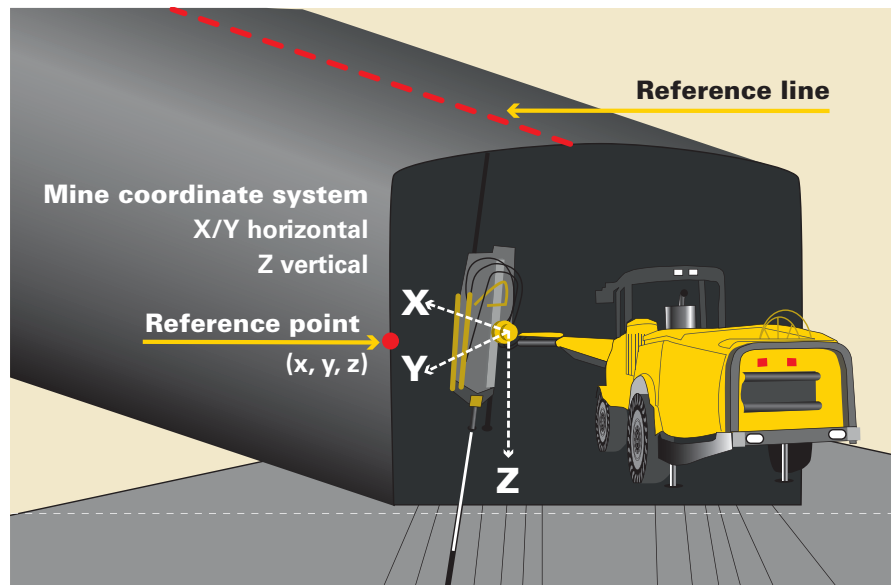

Navigation system for downwards longhole production drilling.

use Quality Log to record drilling parameters and compare the planned and actual result, allowing holes to be re-drilled if necessary. This new technology will help Garpenberg to optimize economy and productivity when applying long hole drilling mining methods.

The target for 2007 was to mine about 600,000 t of ore by cut-and-fill, 300,000 t by sublevel stoping, 150,000 t by rill mining and 150,000 t by crown pillar removal. Further ahead, sublevel stoping is expected to contribute up to 50% of total mine production. However, at present this mining method is completely new to the mining teams at Garpenberg, and they have just started the process of getting acquainted with long hole drilling methods.

## Longhole drilling at Lappberget

After perfecting its longhole drilling techniques at its Tyskgården orebody, the Garpenberg mine began open stoping of the Lappberget orebody using Simba M6 C and Simba M7 C production drill rigs. These are drilling primary and secondary stopes, 10 and 15 m wide respectively, and 20-25 m high.

At one of the primary stopes, at the 1060 level, the Simba M7 C has been drilling up-hole fans using T38 rods since late 2006. The 70 mm holes range in length up to 20 m. The Mine Navigation system is used to position the rig

in the drift and drill towards the exact coordinates set by the drill plan.

The Simba M6 C, meanwhile, is drilling down-holes on the 870 level. Operators report that, when the rig is used in the automatic mode, the automatic bit changer is essential because the rock can wear down several bits per fan. Holes are 76 mm diameter and vary in length up to 25 m with a maximum burden of 2 m.

The automatic bit changer has a circular cassette containing new drill bits to replace those worn out during drilling. During bit changing, the drill rods are retracted and stored in the rig's rod magazine, after which the rock drill collects the worn bit from the shank adapter. This is deposited in the bit cassette, which then revolves to present a new bit to the rock drill. Thanks to the bit changer, the drill rig can be used in the fully automatic mode for a whole shift.

The mine recently commissioned a second Simba M6 C for production at the Lappberget orebody, and a Cabletec LC cable bolting rig has also been acquired for rock reinforcement.

## Acknowledgements

*This article is based upon an original report by Kyran Casteel. Atlas Copco is grateful to the mine management at Garpenberg for their assistance with site visits, and in particular to Tom Söderman for comments and revision.*



*Headframe at Garpenberg.*



# Changing systems at Zinkgruvan

## Partners in production

Zinkgruvan Mining, Sweden's third largest mining company, is owned and operated by Lundin Mining Group. Zinkgruvan Mining produces zinc concentrate (55% Zn) and lead concentrate (73% Pb and 1,400 gm/t Ag) and ships to smelters in northern Europe.

The mine has been continuously in production since 1857, and ore output in 2006 was 787,000 t, together with around 250,000 t from waste development. Average zinc grades were high at 10.3%, whereas lead grades fell to 4.6%, and silver to 93 gm/t. For 2007, ore production is planned at 850,000 t, and a project to increase reserves is underway.

Zinkgruvan ore reserves total 11.2 million t, containing 9.3% zinc, 4.3% lead and 107 g/tonne silver, equivalent to approximately 15 years of production. Added to this, discovered in the 1990s, is a copper mineralization of 3.5 million t containing 3.1% copper and 49 gm/t silver.

Production is obtained from open stopes where, following difficulties with seepage from hydraulic fill when rock quality diminished, the mine now uses paste fill. Rather than deepen the main hoisting shaft, the main ramp access was developed below the 800 m level and will bottom out at 1,100 m under present plans. Key to Zinkgruvan production efforts is equipment supplied by Atlas Copco, which includes three Simba production drill rigs equipped with Secoroc tube-drilling systems, two Boomer drill rigs equipped with Secoroc Magnum SR35 equipment, and two Boltec rigs, together with long-term maintenance and consumable supply contracts.

## Methodology

Until the mid 1980s, upwards cut and fill was the dominant mining method. However, when mining began at the 650 m level in Nygruvan, the first problems with rock stress occurred, resulting



Longhole drilling with Simba M4 C in the Burkland stopes.

in the need for increased rock reinforcement. When mining reached the 566 m level, a borehole camera survey revealed a roof split 6 m above the stopes, causing abandonment of cut and fill methods on safety grounds.

Benching methods were introduced, and have been under constant development since, primarily because of high rock stress. Using benching, no working place need be developed wider than 7 m.

Over the years, benching has developed from longitudinal bench and fill. The mined out bench is backfilled with hydraulic fill before mining the next bench above. Vertical pillars in the ore are left to stabilize the surrounding rock.

## Open stoping

Development continued towards sublevel open stoping, which is a larger scale stoping method than longitudinal bench and fill, with improved rock stress.

Sublevel open stoping as a production method worked excellently in Nygruvan, where the country rock is of extremely good quality. The ore is homogeneous, with distinct ore boundaries where dip in the ore is greater than 75 degrees. The open room that is formed after the stope is mucked has height measurements of up to 70 m, width of 15 m, and a length of 50 m. After mucking is completed, the drawpoints are sealed with bulkheads, and filled with hydraulic fill.

In the mid 1990s, the Burkland orebody was developed. Rock quality and ore geometry were different compared to earlier orebodies, and a project was initiated to utilize a modified sublevel open stoping method for orebodies with weaker hanging walls, but retaining the advantages of the stoping method.

In this method, open stopes have the approximate dimensions 40 m high x 50 m long, and the orebody width up to 30 m. Pillars up to 10 m thick are left between every stope to support the



Ergonomically-designed cab on the Simba M4 C drill rig.

hanging wall, so some 16% of the ore is utilized as pillars.

After the first stope was mined in late 1998, the quality of the hanging was found to be worse than expected, with cave-ins, high waste rock dilution, and difficult backfilling.

### Burkland stopes

Earlier, a study of the new copper orebody had recommended that longhole open stoping and paste backfill should be used when the width of the copper mineralization reaches up to 40 m. The

results of this study were adapted to the Burkland orebody, where the 450 section was converted to longhole open stoping with primary and secondary stopes. The first two primary stopes were mined out by October, 2000.

When the primary stopes are extracted, they are paste filled. The secondary stope, lying between two paste filled stopes, can then be mined out and filled with waste rock, or paste fill with a low cement content.

The stope design in the upper levels in Burkland was chosen to facilitate the change from sublevel open stoping to longhole open stoping. The levels were already arranged in 100 m sequences, so the height of the stopes became 37 m. Stope width was designed to be about half the room length used for sublevel open stoping. The primary stopes were designed to be 20 m long, with the secondary stopes 25 m long.

The stope hanging walls are cable reinforced from the ore drive on the extraction level, and on the upper sublevel, using 15.7 mm cables with maximum tensile strength of 265 KN. The crosscuts are cable reinforced and shotcreted to secure the footwall brow.

Mine-wide, four longhole rigs are used for production and cable drilling.

Stope drilling and cable bolting.

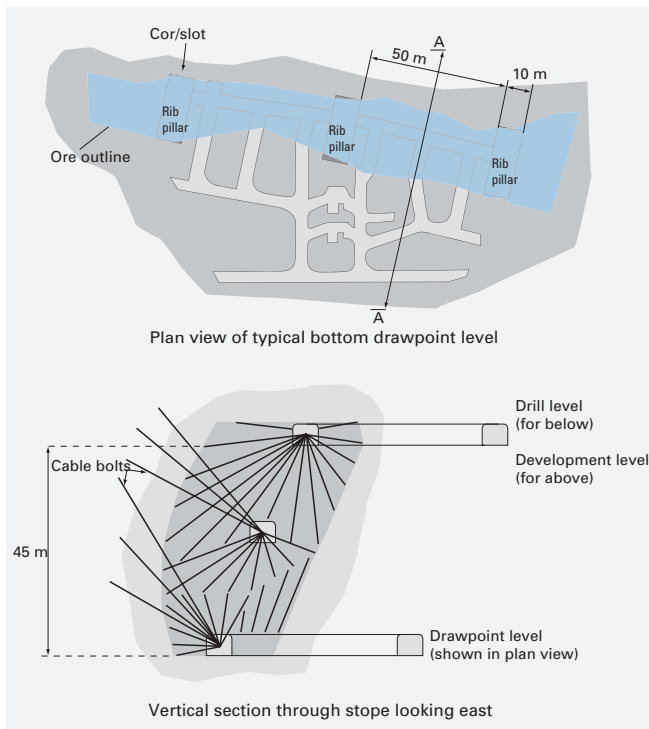

Stoping sequence.

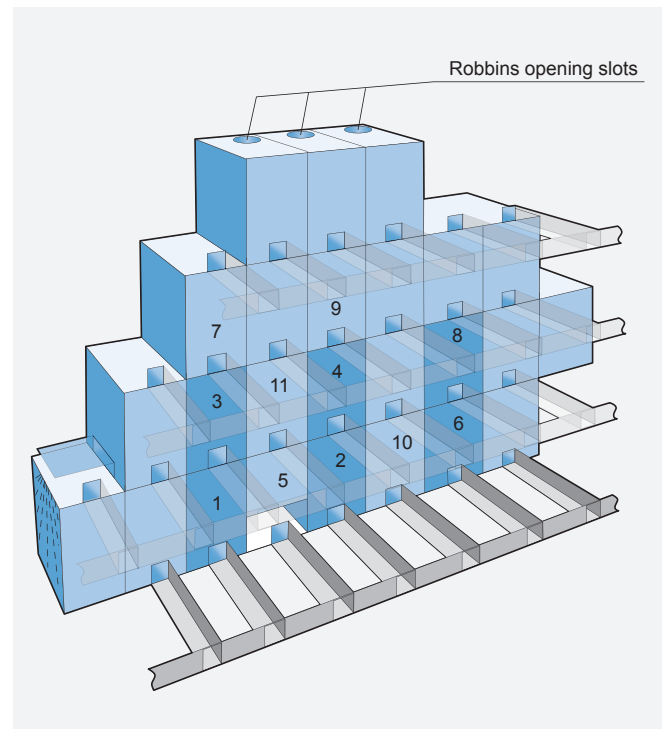





Stopes are drilled downwards from the orebody drives, and from the crosscuts in the top sublevel. The benches are opened on a 600-1,200 mm diameter raise bored hole, with an opening slot along the hanging wall. Blasting is sequential, and rock is loaded from the extraction level below.

The transition to longhole open stoping has contributed to a lower production cost, but the fill adds expense. However, because the method does not normally require pillars, no rock is sterilized when mining the secondary stopes. These savings offset the fill costs, and 800,000 t is added to the ore reserves.

CMS surveys on the first two primary stopes in Bu 450 showed that drilling and blasting had followed the ore boundaries according to plan.

## Paste fill

Hydraulic fill was introduced to Zinkgruvan in the early 1970s when the new mill was built, and was used successfully for many years. However, during the transition to sublevel open stoping, difficulties arose in sealing the open stopes when using hydraulic fill. The bulkheads could not be sealed against the cracked rock in the draw points, and there was also seepage through cracked pillars. Because of the difficulties of managing the fill, certain stopes have not been filled, as the risk of fill collapsing is greater than the chances of a hanging wall collapsing in the open stopes.

Alternatives that were studied included hydraulic fill, with cement for about 50% solidity; paste fill, with cement for 70-76% solidity; and high-density fill, with cement for greater than 76% solidity. Paste fill with cement was selected for longhole open stoping with primary and secondary stopes. Investments required in the paste plant, and for pipe installations underground, reached about 45 million SEK. Golder Paste Technology, together with Zinkgruvan personnel, handled the design, construction and building.

## Stope design criteria

The design of stope sizes was based on the developed levels in the Burkland



Rocket Boomer M2 C developing the sublevels.

Paste fill specifications		
	Nygruvan	Burkland
Primary stope	4 % cement	6 % cement
Secondary stope	1.5 % cement	2 % cement
Slump	150-180 mm	200-250 mm

ore. The paste fill is horizontally transported 1.4 km in order to reach these

stopes, so has to be pumpable. The fill also has to have a minimum strength

Plan of stope extraction level.

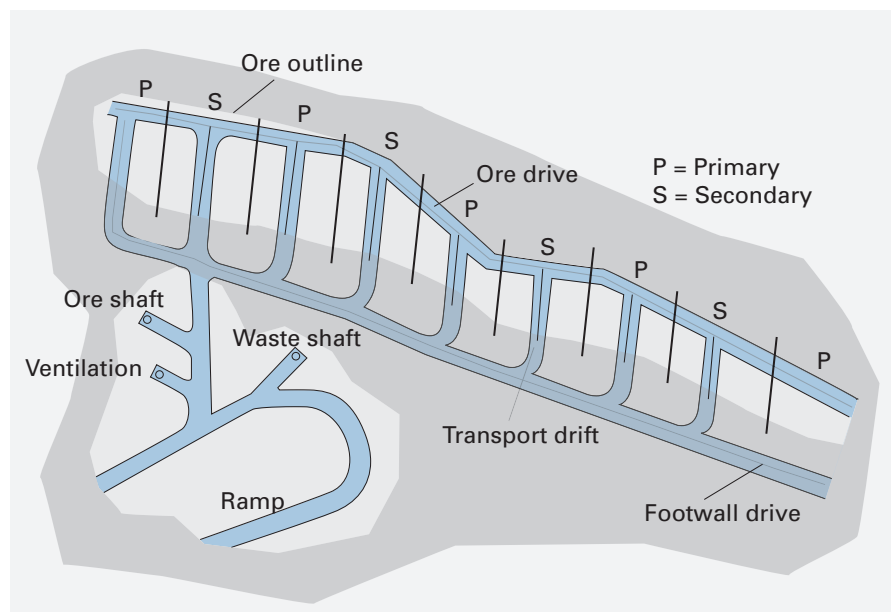



*Boltec LC installing rockbolts in a development drift.*

of 0.35 Mpa, to handle a free-standing height of 40 m. The one-axial pressure-test and pumpability test resulted in the specifications for paste fill in the two orebodies shown in Table 1.

Paste fill is transported to the 350 m level of the mine through two boreholes, a 165 mm hole for gravitating into Nygruvan, and a 300 mm hole for pumping under high pressure into Burkland.

The fill is transported through 6 in steel pipes along the distribution levels, connected by plastic pipes into the stopes.

Advantages of longhole open stoping with paste fill are: improved working environment for all underground activities with regards to exposure of open stopes and backfill; reduced pillar reservation, leading to increased ore reserves; increased flexibility, with more stopes in simultaneous production and lower grade fluctuation; all tailings can be used; no bulkheads required; reduced

drainage water; and possibility of filling abandoned stopes.

Disadvantages are: higher costs than conventional hydraulic fill; and plugged fill pipes and drill holes require more effort.

The long-term focus is directed towards optimization of the water/cement ratio in the paste fill, with a view to reducing the amount of cement used.

## Lower development

In order to mine below the 800 m level, the mine uses three Kiruna Electric trucks for ore and waste haulage to the main crusher. A Simba M4C longhole drill rig is used on production, drilling up to 40 m long x 76 mm or 89 mm diameter blastholes. The machine produces some 50,000 drillmetres/year, while an older Simba 1357 drills a similar number of metres in the 51-64 mm range. The mine is so impressed with the stability of the Simba M4 C rotation

unit that it has had an old Simba 1354 rebuilt to incorporate the same unit. A new Simba M7 C handles the cable bolt drilling. The drilling consumables are supplied by Atlas Copco Secoroc under contract. The ramp will be driven from the current 980 m to the 1,100 m level.

An Atlas Copco Rocket Boomer L2 C is used on ramp and sublevel development, where the requirement is for 18 rounds/week on a 2 x 7 h shift basis. The mine has purchased a second twin-boom Rocket Boomer, this time a Rocket Boomer M2 C, which is the mining version of the Rocket Boomer L2 C.

## Rock reinforcement

The mine installs up to 20,000 resin anchored rockbolts each year, and, having upgraded its production process, found that bolting became the new bottleneck. After prolonged testing of the latest Atlas Copco Boltec LC, they ordered two units.

Using these machines, the working environment for the bolting operatives has improved immeasurably, since the continuous manual handling of resin cartridges has been eliminated. The Boltec LC is a fully mechanized rockbolting rig, with computer-based control system for high productivity and precision. The Zinkgruvan models feature a new type of magazine holding 80 resin cartridges, sufficient for installation of 16 rockbolts. It is equipped with a stinger, which applies constant pressure to keep it stable at the hole during the entire installation process. The operator can select the number of resin cartridges to be shot into the hole, for which the blow capacity is excellent.

The Rig Control System (RCS) features an interactive operator control panel, with full-colour display of the computer-based drilling system. Automatic functions in the drilling process, such as auto-collaring and anti-jamming protection, as well as improved regulation of the rock drill, provide high performance and outstanding drill steel economy. There is integrated diagnostic and fault location, and a distributed hydraulic system, with fewer and shorter hoses for increased availability. Data transfer is by PC-card, which also allows service engineers to store optimal drill



settings. The MBU bolting unit on the Boltec LC features a single feed system, utilizing a cradle indexer at the rear end, and a robust drill steel support plus indexer for grouting at the top end. It is equipped with a low-mounted magazine for 10 bolts, designed for maximum flexibility during drilling and bolting.

The COP 1432 rock drill fitted to the Zinkgruvan Boltec LC, and its successor, the COP 1132 rock drill, are the shortest in their class, with modern hydraulic reflex dampening for high-speed drilling and excellent drill steel economy. They have separately variable frequency and impact power, which can be adapted to certain drill steel/rock combinations.

The BUT 35HBE heavy-duty boom is perfect for direct, fast and accurate positioning between holes, and, at Zinkgruvan, this has been extended by 700 mm. Large capacity working lights and a joystick-operated spotlight ensure that the operator has outstanding visibility.

The Rig Control System (RCS), originally developed for Boomer rigs, is now also installed on Simba and Boltec rigs, so the mine benefits from the commonality.

## New facilities

Lundin Mining Corporation took over Zinkgruvan in 2004, and by the second quarter of 2007 a total of 218,065 Mt of ore was mined, representing a 13.8% increase over the same period in 2006. The company has continued intensive near-mine exploration and pursued a programme of upgrades. In 2006, they added a new facility to store drill core samples, overhauled the ventilation system to reduce energy consumption, and completed the restoration of previously worked land.

The Zinkgruvan operation now makes extensive use of contractors, and 50–60 contractor personnel are on-site supporting the mine's nearly 300 employees at any given time. Contractors have been brought in to perform core drilling, shotcreting, development work and plant maintenance, amongst other tasks.

As a result of newly discovered copper resources, Lundin Mining announced in October, 2007 that SEK 246 million

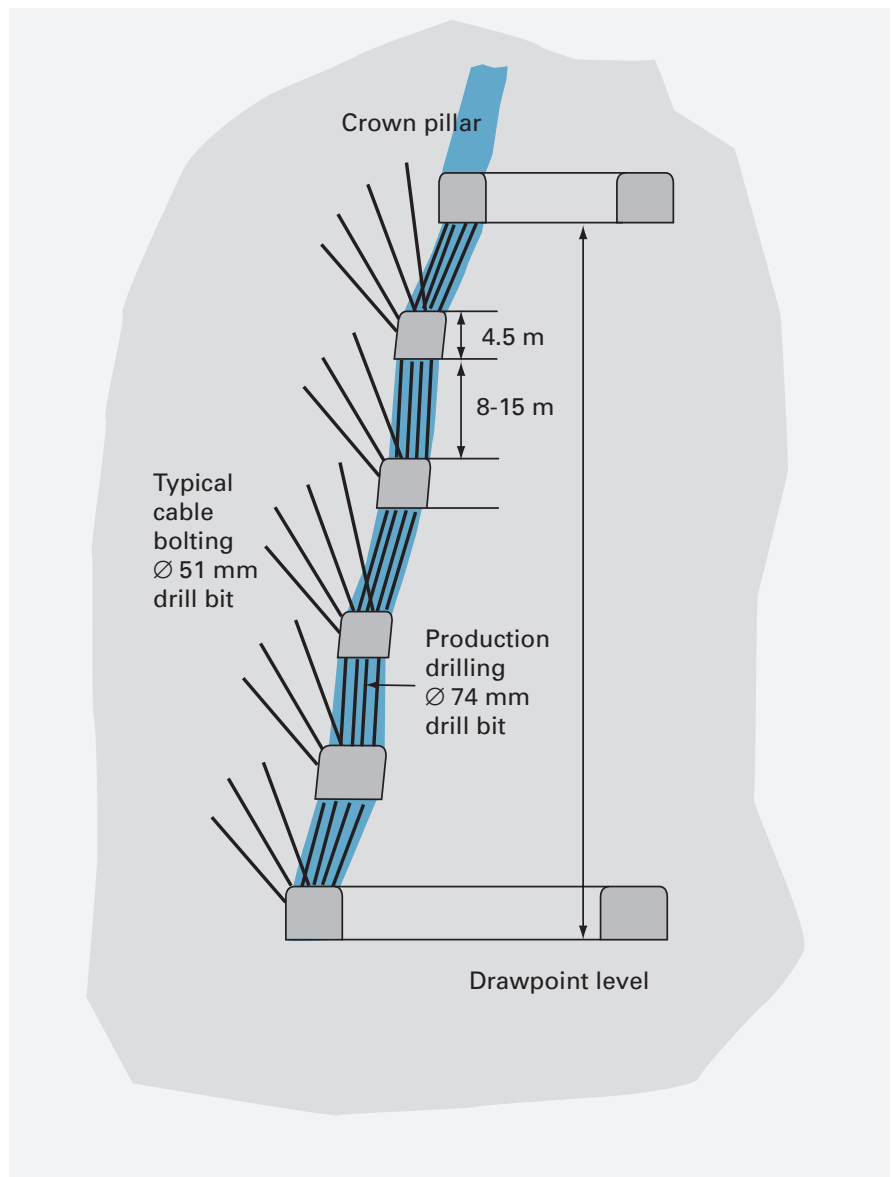

Typical cross section of the orebody looking east.

Primary stope drilling layout.

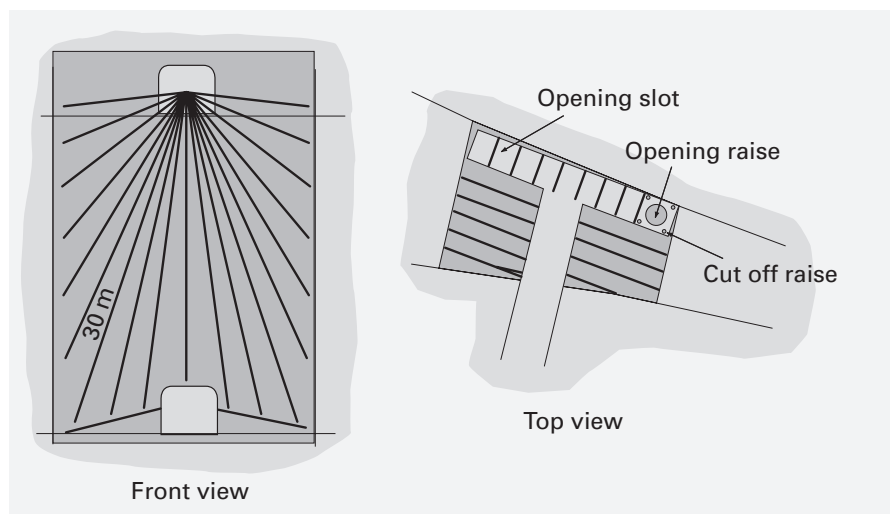



*Boltec LC in for service.*

would be invested to raise the mine's annual ore production to 1.2 Mt. The mine will also process the copper into concentrate.

Another key initiative, taken in 2006, was the development of a new life-of-mine business plan, with the aim of increasing the life of the mine and its total asset value.

The plan is based on the Inco MINE 2-4D system for mine design and scheduling, which works with Zinkgruvan's MicroStation software. A key goal of the plan is increased near-mine exploration to secure an output of at least 900,000 t/y ore from 2008 to 2019.

## **Pioneering partnership**

In a pioneering deal with Atlas Copco, the mine has undertaken an eight year agreement in which the mine's production fleet will be re-purchased by Atlas Copco and then leased back to the mine. The mine will hand over the running of the eight rigs in order to focus on its

core business of mining – effectively outsourcing the fleet and the associated tasks of servicing, maintenance and replacement. A cost and profit sharing element has been built into the agreement, so there is a common interest in providing optimal service in the most efficient way.

The monthly rentals for the rigs are fixed and each rig will be exchanged for a new one at a predetermined time throughout the life of the contract to ensure optimum productivity. Arranged through Atlas Copco Customer Finance, the new deal includes financing, service and logistical supply.

The Atlas Copco service team at the site has been strengthened in light of the new agreement, and now works in two shifts to provide service cover during production, from six in the morning to nine in the evening. A normal day sees one drill rig receiving a full service, as well as preventative and scheduled maintenance tasks. As a result, the best possible service is delivered in the most cost

effective way, and the mine is ideally positioned to maintain maximum output.

From the mine point of view, maintenance of their equipment requires specialist competence, and through the agreement with Atlas Copco, they have constant back-up. If they have a breakdown, they can get production up and running again quickly with a reserve rig and avoid any losses in productivity.

Mines, in general, are becoming more aware of the benefits that financing can bring, giving them control over the costs associated with their production fleet, assisting long-term planning and forecasting.

## **Acknowledgements**

*This article is based on a paper written by Gunnar Nystrom. Atlas Copco also gratefully acknowledges the inputs of Hans Sjoberg and Conny Ohman, both of Zinkgruvan Mining.*



# Increasing outputs at LKAB iron ore mines

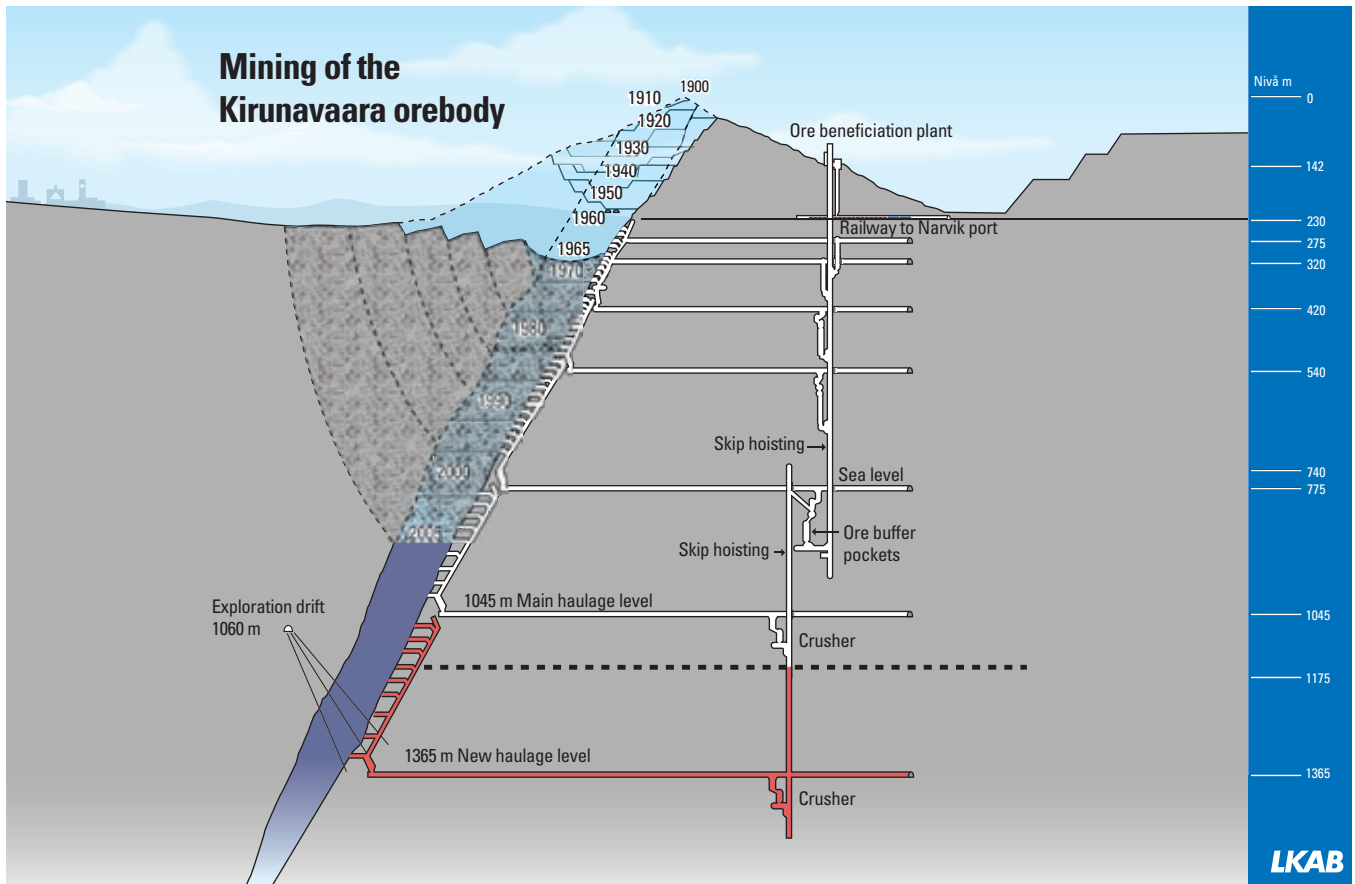

## Optimum techniques

For more than 40 years, the miners of LKAB in the far north of Sweden have been working to get as close as possible to the optimum underground mining technique. At Kiruna, in what is the world's largest underground iron ore operation, many milestones have been reached and passed. Now another is on the horizon as the mine takes new steps to go deeper and expand. Sister mine Malmberget is also expanding output, albeit on a lesser scale. Key to both is a collaboration with Atlas Copco that is providing specialized drilling equipment together with the means of maintenance.

*Mining of the Kirunavaara orebody over the last century.*

## Continuous quest

The Swedish state-owned mining company LKAB is on a continuous quest for the most favourable balance possible in the relationship between ore recovery, waste dilution, overall costs and productivity. Much of the development work done here has been carried out in close cooperation with equipment suppliers, including Atlas Copco.

LKAB's relationship with Atlas Copco began in the early 1960s, with mechanized drilling equipment which was the predecessor of today's automated long-hole production drilling system.

In 1997, Atlas Copco supplied LKAB with four Simba W469 drill rigs equipped with a PLC control system. This

technology is now being successively upgraded with the latest generation of rigs equipped with a PC-based Rig Control System RCS, the Simba W6 C fitted with LKAB's Wassara W100 in-the-hole hammer.

LKAB operates two large mines north of the Arctic Circle, where its Kiruna and Malmberget mines together supply about 4% of the iron ore requirements of the world's steel industry. With no sign of a slow down in demand, the company has ambitious plans for the future. These include new main haulage levels at both mines, which this year alone will require the development of some 40 km of new drifts.

The modern Simba production drilling rigs have made a clear difference in



*Simba W6 C drilling upholes at Kiruna mine.*

LKAB performance, increasing output by 40%. In 2007, Kiruna will extract around 27 million t of crude ore, with a plan to increase to 30 million t in 2009. Malmberget's plan is less ambitious, but significant, in moving production up

*Setting up a Simba W6 C for production drilling.*



from its 2007 base of 16 million t to 17 million t in 2012.

### Optimizing ore recovery

The Kiruna orebody is a single large slice of magnetite about 4 km-long and 80 m-wide, extending to a depth of 2 km with a dip of around 60 degrees. Sub-level caving is used, drilling upward fans of 115 mm-diameter holes. The method lends itself to a high degree of automation, resulting in high productivity. LKAB is constantly striving to minimize ore losses and waste dilution, seeking the best combination to achieve optimum results.

Under investigation are: analysis of the positive effects of accurate drilling on ore recovery rates, waste dilution and fragmentation; the impact of alternative drill fan configurations and hole burdens on mucking and operating costs; and the optimum distance between levels.

All agree on one thing: straight, accurate holes which reach their preplanned target points are vital, because hole deviation has a negative impact on all aspects of the production operation.

Thanks to the improving ability to drill straight holes, LKAB has been

able to gradually increase the spacing between the sublevels from 12 m in the mid-60s using compressed air-powered, topammer rock drills, to today's 30 m using water powered ITH hammers. This has resulted in controlled levels of ore losses and waste dilution. However, the mine wants to raise the bar even higher, believing there is still much more that can be done to increase efficiency, productivity and overall economy.

### Increasing outputs

From their control rooms, the LKAB operators run several drill rigs out in the production areas via remote control. The fans are drilled forwards, 10 degrees off vertical, generally with a burden of 3 m, although a 3.5 m burden is used in some parts of the Malmberget mine. Pumped emulsion and Nonel detonators are the standard explosives.

Kiruna mine is aiming to achieve one million metres of production drilling in 2007. Malmberget, on the other hand, is going for 0.6 million metres. But both will need to increase their capacity in order to maintain and increase the buffer between production drilling and loading.

It was in 2005 that LKAB took the decision to install three Simba W6 C units which are modified versions of the Simba L6 C. Two of these are designed for optimized production drilling at Kiruna Mine with the Wassara water hammer.

The third, a Simba W6 C Slot, was redesigned for optimized up-hole slot drilling in the Malmberget mine. This rig has the ability to drill production holes around the slot, with the added benefit of drilling parallel rings from the same set-up with a burden of 500 mm.

The criteria from LKAB were high productivity, efficiency and accuracy. The rigs in the Kiruna mine will have to drill 60 m-long holes in order to meet future targets.

Such long holes have to be very straight, and with the new rigs LKAB has high expectations for both production rates and precision, with the flexibility of being able to run the rigs manually as well as automatically. The Wassara hammer has the advantage that it does not leak oil into the environment.

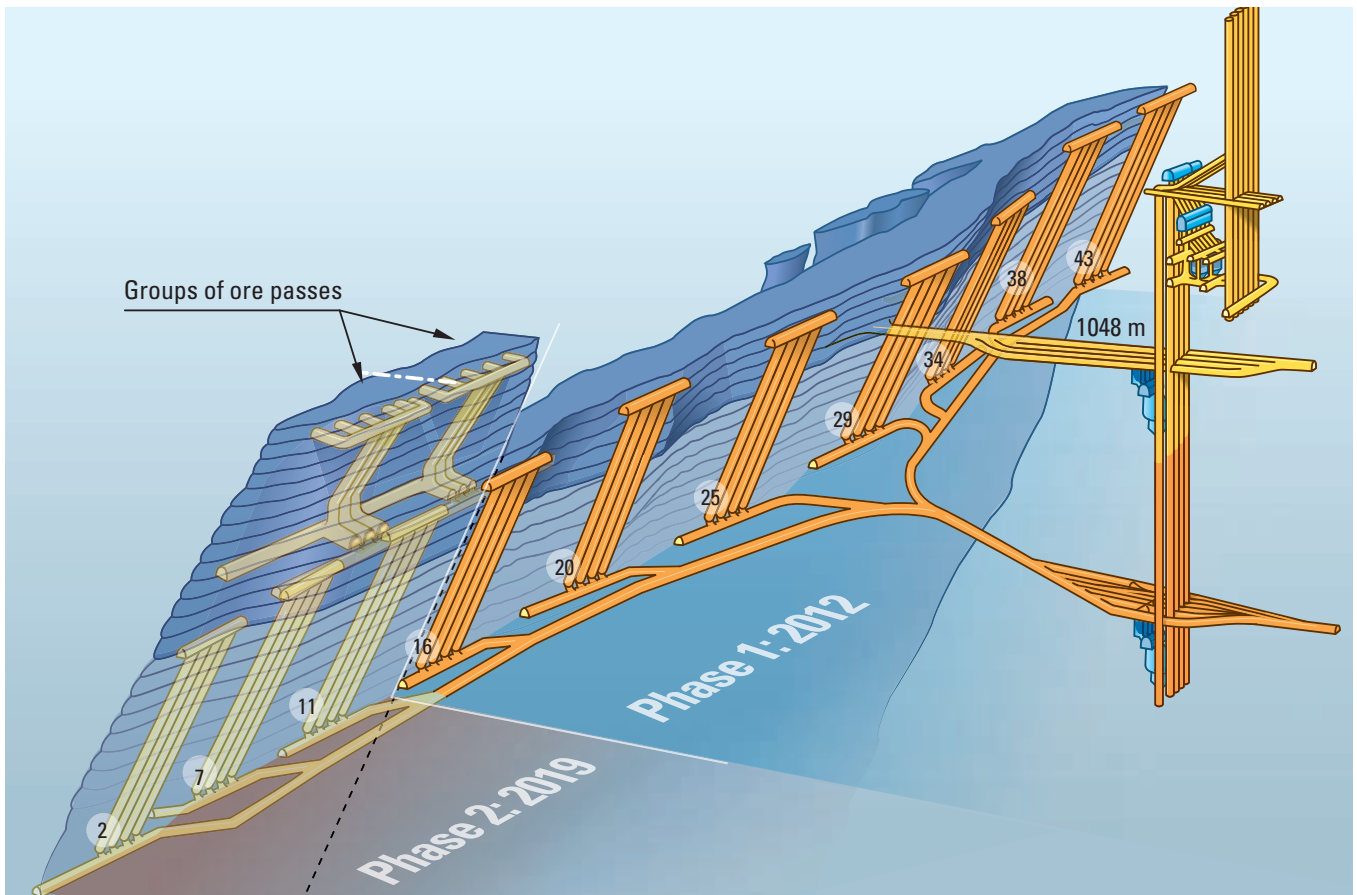

Development of 1365 m haulage level at Kiruna.

For each of the Simba W6 C rigs LKAB has set targets of 80,000 drill-metres/year. Since October 2006, the two drill rigs at Kiruna have achieved 65,000 and just over 70,000 drillmetres/year respectively, with an average monthly performance of 10,000 drillmetres.

## Alternative configurations

The rigs drill alternative configurations with holes 15-58 m long. The fans are spaced at three metre intervals, and any deviation of more than 2% might cause the fans to overlap. The average penetration rate is 0.65 m/min over the entire hole, which can be compared to top-hammer drilling where the penetration

rate drops with hole depth, and the risk of deviation increases.

All of the rigs have drill tube magazines which are sufficient for drilling the required hole lengths, thereby eliminating the need for manual addition of tubes. They are also equipped with a PC-based Rig Control System (RCS) specially designed for ITH applications. The new water pump system reduces water spillage and lowers the overall cost. The pump pressure control has been modified to optimize hammer efficiency.

With increased automation and reduced manning there is a growing need for remote surveillance. Atlas Copco's Rig Remote Access (RRA) interface allows the user to connect the drill rig

to an existing network system via LAN or WLAN. RRA is used for remote supervision when drilling unmanned in full fan automation, as well as for transferring drill plans and log files and handling messages from the rigs' control systems.

If manual operation is preferred, the rig cabin offers a good working environment with vibration damping and noise insulation.

The LKAB rigs are working with ABC Total, the highest level of automation, facilitating drilling a full fan in automatic mode with only some initial steps needed from the operator. Within the ABC Total package, there is also the possibility to drill manually or with one-hole automatics if preferred. The

*The Wassara W 100 hammer on the Simba W6 gives good penetration and, as it is water-powered, does not release any oil into the air.*



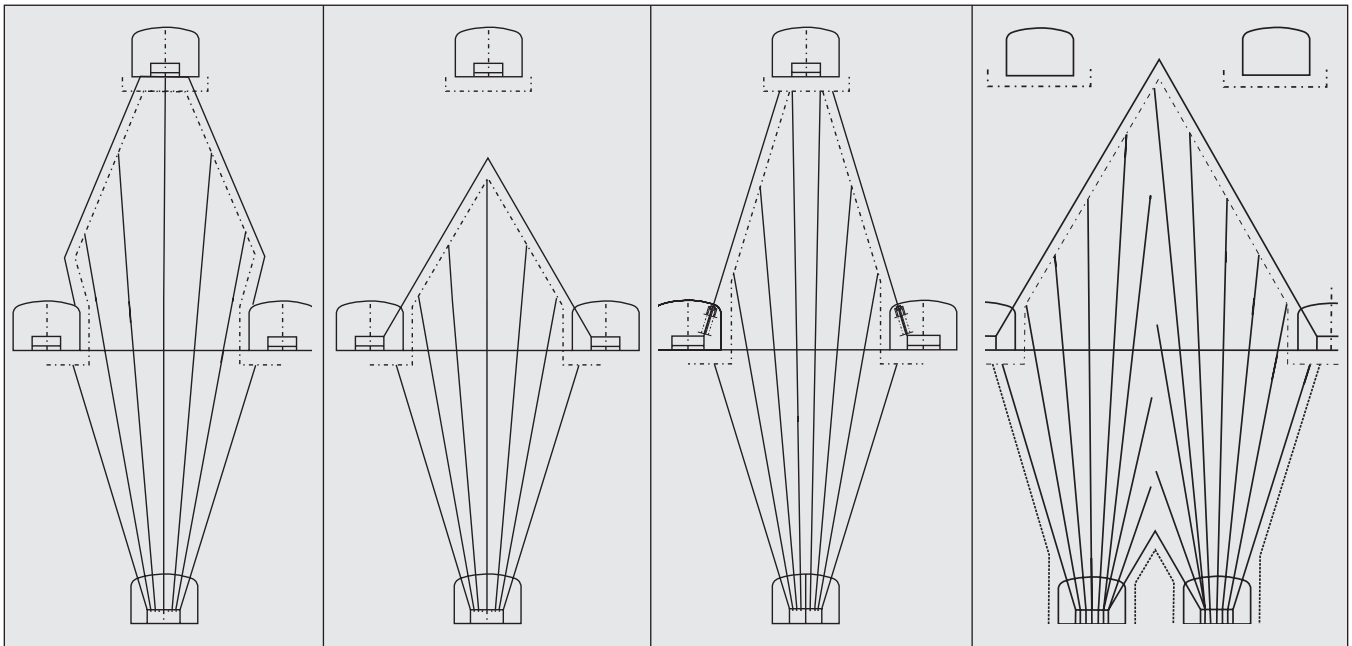

Alternative drilling configurations under consideration by LKAB.

automatic systems also enable the rigs to run unmanned during shift changes, lunch breaks and night shifts.

## Service agreements

Both LKAB mines have full service agreements with Atlas Copco, who provide continuous preventive maintenance for their fleet of 20 rigs. Under the terms of the agreement, Atlas Copco runs a thorough check on each rig at the rate of one per week. The agreement, which is based on the number of metres drilled, also includes the supply of all spare parts. Only genuine Atlas Copco parts are used on contract maintenance, guaranteeing longer service life and greater availability.

The availability target is 92%, and penalties are payable on underperformance, with bonuses awarded if the targets are exceeded. LKAB is pleased with the agreements and the way they have been designed, feeling they can let go of the maintenance responsibility and concentrate on drilling.

Many changes have been introduced to ensure communication between mine and manufacturer on a regular basis, resulting in a mutual approach to problem solving with a focus on proactive and preventive maintenance.

One of the most important changes was to reorganize the service intervals

to better fit in with LKAB schedules. Another was to move the service centre for the team of 18 service and maintenance staff from underground to surface.

LKAB confirms that the improvements have had the desired effect, with more consistent maintenance. Regular meetings, spontaneous as well as planned, ensure a more structured approach to

problems. As a result Atlas Copco is seen by LKAB as safe and reliable.

## Acknowledgements

*Atlas Copco is grateful to the managements of Kiruna and Malmberget mines for their assistance in the production of this article.*

*All on the same team: From the left, Robert Wetterborn, Construction Supervisor, Mining Dept. at LKAB, Patrik Kansa, Atlas Copco Service Manager and Roger Lärkmo, Production Manager, Production Drilling at LKAB.*







# Production control at Kemi chrome mine

## Intelligent mining

The large chromite deposit being mined by Outokumpu at Kemi, Finland has a lower than average  $\text{Cr}_2\text{O}_3$  content of about 26%, so chromite and ferrochrome production technology has had to be continuously upgraded to remain competitive.

The Intelligent Mine Implementation Technology Programme of 14 projects achieved real time control of mine production in precise coordination with the needs of the mineral processing plant and the ferrochrome smelter. The system utilizes a fast, mine-wide information system that can help optimize financial results for the whole operation. Computerized drilling with Atlas Copco Rocket Boomer and Simba rigs, accurate coring with Craelius rigs, reliable rock reinforcement with Cabletec and Boltec rigs with Swellex bolts, and the dependability and longevity of Secoroc drilling consumables support this unique mine strategy. An automated Scooptram ST14 has been evaluated for backfilling, with good success. The result is cost-efficient, integrated production, on a model which may form the basis of the next generation of mining techniques.

## Introduction

Outokumpu is one of the world's largest stainless steel producers, accounting for about 8% of global stainless slab output, and a similar share of cold rolled production. These are hugely significant proportions of a market that has risen by an average of 5.5% per annum over the last 20 years, and is currently enjoying 7% growth.

Mainstay of the Outokumpu strategy is its highly cost-efficient fully integrated mine-to-mill production chain in the Kemi-Tornio area of northern Finland. An ongoing investment programme of EUR1.1 billion will expand

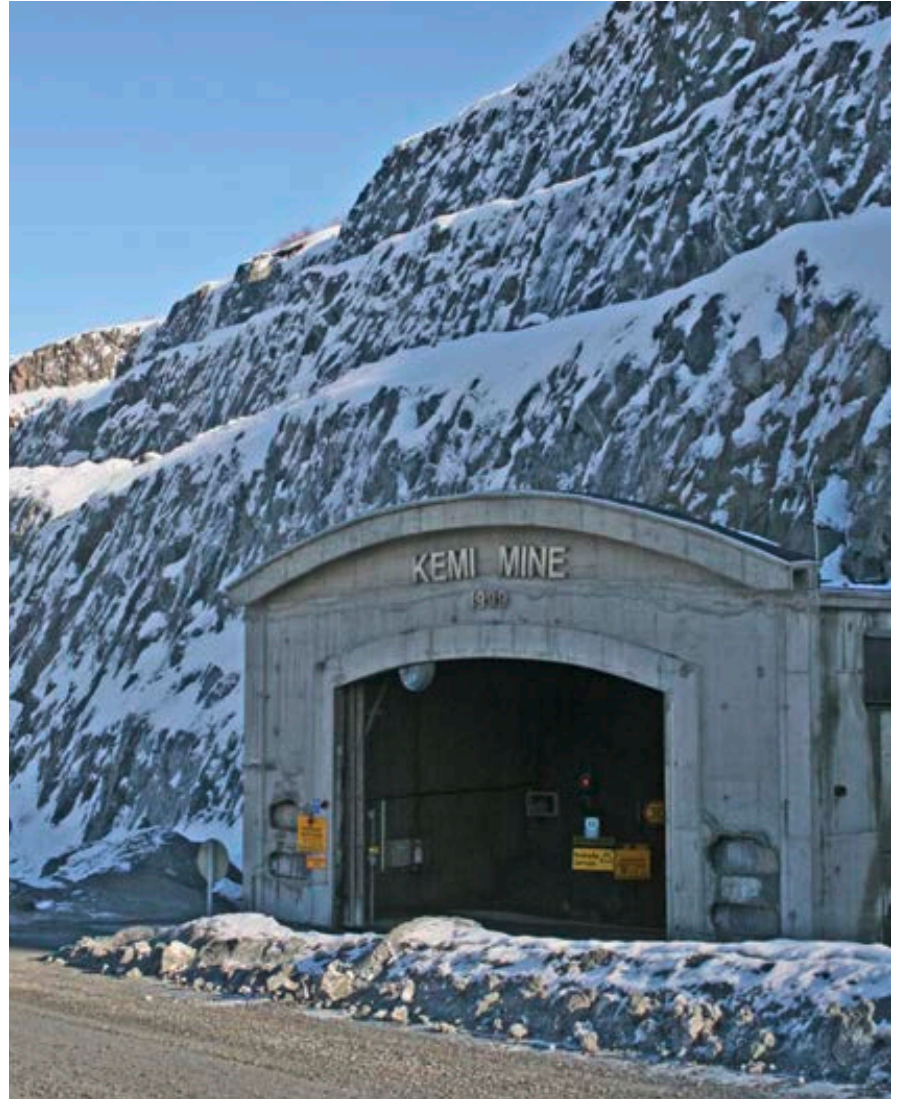

Access to the underground operations at Kemi mine.

total slab capacity from 1.75 million t to 2.75 million t, and coil rolling capacity from 1.2 million t to 1.9 million t.

Ore reserves at Kemi chrome mine are abundant, and the efficiency of the Tornio smelter is enhanced by its proximity to both the mine and harbour facilities. Mining production has been progressively switched from surface to underground, where intensive use is being made of information technology to optimize the overall mining and processing operation. Underground mining

started in 2003 at 150,000 t/y, and production will increase to the planned level of 1.2 million t/y by 2008.

## Reserves

The Kemi deposit is hosted by a 2.4 billion year old mafic-ultramafic layered intrusion extending for some 15 km north-east of the town itself. The chromite-rich horizon appears 50-200 m above the bottom of the intrusion, and has an average dip of 70 degrees

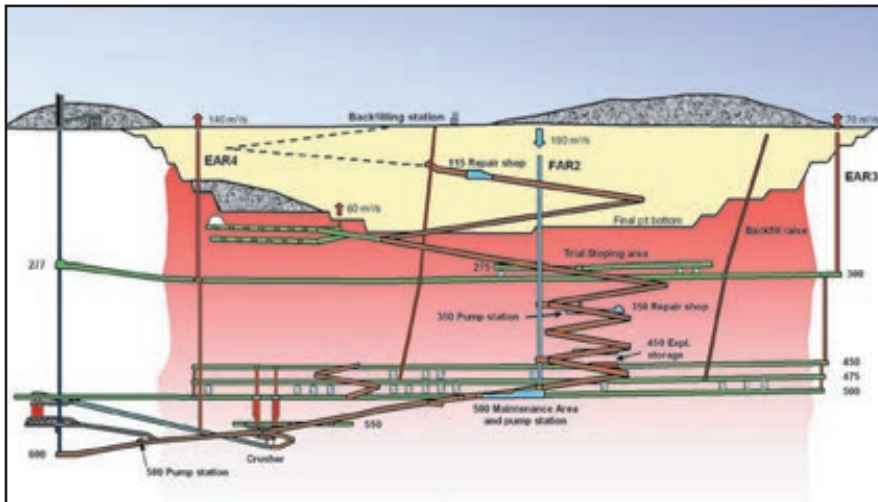

Kemi underground mine – simplified long section.

northwest. The main immediate host rock is weak talc-carbonate, in which the hanging wall contact is clearly defined. At the footwall, the chromite and host rock is inter-layered, and must be mined selectively. However, there is strong granite some 80 m below the footwall.

The Kemi chrome deposit comprises 11 mineralizations within a 4.5 km long zone varying from 5-105 m in width, with average thickness of 40 m, a mineral resource of over 150 million t of 28.6% Cr<sub>2</sub>O<sub>3</sub>. Of this, there are 50 million t proven reserves underground between the 500 m level and the bottom of the open pit. The ore body continues at depth, probably to 1,000 m, with 750 m having been reached by the deepest exploratory hole. The 1.5 km long

x 500 m wide main pit has a final planned depth of 220 m.

A two shift/day, five day/week pattern is worked in the mine, from which about 1.2 million t/y of ore grading 24-26% Cr<sub>2</sub>O<sub>3</sub> is processed continuously by the concentrator. The yield is 220,000 t/y of 12-100 mm lumpy concentrate with 35% Cr<sub>2</sub>O<sub>3</sub>, and 420,000 t/y metallurgical grade concentrate at 45% Cr<sub>2</sub>O<sub>3</sub>. Over the years, more than 30 million t of ore have been produced from open pits, resulting in 130 million t in the waste heaps.

## Ore grade control

Ore grade control in both the open pit and the underground mine involves intensive wire line diamond core drilling,

to determine boundaries and qualities of specific ore types. In addition, all blast holes in the open pit are sampled. Technical innovations for ore characterization and quantification include OMS-logg down hole logging, and automated image analysis for establishing grain size distribution.

Basic production data about mineralogical and process histories are logged for each ore stope on a daily basis, and this is merged and compared with daily and blast-specific production histories from the database.

Each ore blast is treated selectively at the concentrator, in order to minimize feed variation and maximize process stability.

In the concentrator, total chromite recovery is around 80%, depending on the proportion of lumpy ore. Metallurgical grade concentrate contains about 45% Cr<sub>2</sub>O<sub>3</sub> of 0.2 mm grain size, while upgraded lumpy ore is about 35% Cr<sub>2</sub>O<sub>3</sub> with 12-100 mm size. The former is pelletised at Tornio, and then mixed with upgraded lumpy ore before smelting to produce ferrochrome.

Concentrator operation is optimized by accurate calibration of the feed slurry analyzers, and control of product quality from each unit process, both by compensating for changes in feed type, and measuring product quality on-line. Manual input can be used, as well as on-line information.

A Craelius Diamec 264 APC drill rig carries out 10 km of coring each year. Drill sections are established every 10 m and downhole survey is standard procedure, using a Maxibore system. Based on the drill hole data, a 3D model of the orebody is created and used as a basis for production planning.

Tying all these streams of collected data and planning outputs together requires an extremely fast communications network, interfacing with a single master database.

## Underground infrastructure

The main decline starts at a portal in the footwall side of the pit, at about 100 m below the rim. The decline is mostly 8 m wide x 5.5 m high, to accommodate passing vehicles. It descends at 1:7 to a depth of 600 m at the base of

Atlas Copco Diamec U6 APC at work underground.





the hoisting shaft, and connects with several intermediate sublevels. The decline is asphalted throughout most of its length.

There is also a 5,000 cu m repair shop for open pit equipment at the 115 m level, and a larger 14,000 cu m workshop at the 350 m level for the underground mobile equipment fleet. The final 23,000 cu m main workshop is at the 500 m level. The 350 m level workshops are enclosed by megadoors, which keep in the heat so that an ambient 18 degrees C can be maintained. The service bay is equipped with a 10 t travelling gantry and 16 m long inspection pit. The washing bay is equipped with two Wallman hydraulically controlled washing cages, so there is no need for operatives to climb onto the mobile equipment.

The main pumping station is located at the 350 m level, and has pumping capacity of 2 x 250 cu m/h. The slurry-type pumps, with mechanical seals, pump the unsettled mine water to the surface with a total head of 360 m. Two other dewatering pumping stations are located at the 500 m and 580 m levels.

The crusher station at the 560 m level is equipped with a 1,000 t/h Metso gyratory crusher. This is fed from two sides by vibrating feeders from separate 8 m diameter main ore passes from the 500 m level, and from one side by a plate feeder, to which the ore can be dumped from the 550 m level. A 40 t travelling gantry crane services the entire crusher house. Crushed ore gravitates onto a conveyor in a tunnel below the crusher for transport to the shaft loading pockets 500 m away.

## Underground production

Trial stopes in three areas accessed from the 275 m and 300 m levels were mined to determine the parameters of the bench cut-and-fill technique to be used. These had a width of 15 m, and were 30-40 m long, with 25,000-30,000 t of ore apiece. Both uphole and down-hole drilling methods were tested, and 51 mm diameter downholes selected as being the safest.

For production purposes, 25 m high transverse stopes are laid out, with cable bolt and mesh support to minimize



*Rocket Boomer L2 C is used for sublevel development.*

dilution. Primary stopes are 15 m wide, and secondary stopes 20 m wide. Cemented fill, using furnace slag from an iron ore smelter and fly ash from local power stations, is placed in the primary stopes, while the secondary stopes will be backfilled with mine waste rock. The primary stopes are being extracted one or two levels above the secondary stopes.

Mining sublevels with 5 m x 5 m cross sections are being established at 25 m vertical intervals, using an Atlas Copco Rocket Boomer L2 C drill rig

equipped with COP 1838ME rock drills and 5 m long Secoroc steel and bits. Rounds of 60-80 holes take about 2 hours to drill, charge and prime. An emulsion charging truck with elevating platform and Atlas Copco GA15 compressor provides fast and efficient explosives delivery. The footwall granite is very competent, but lots of rock reinforcement is required in the weaker host rock, where all drives are systematically rock bolted and secured with steel fibre reinforced shotcrete. The planned nominal capacity is 2.7 million

*Stoping sequence at Kemi mine.*

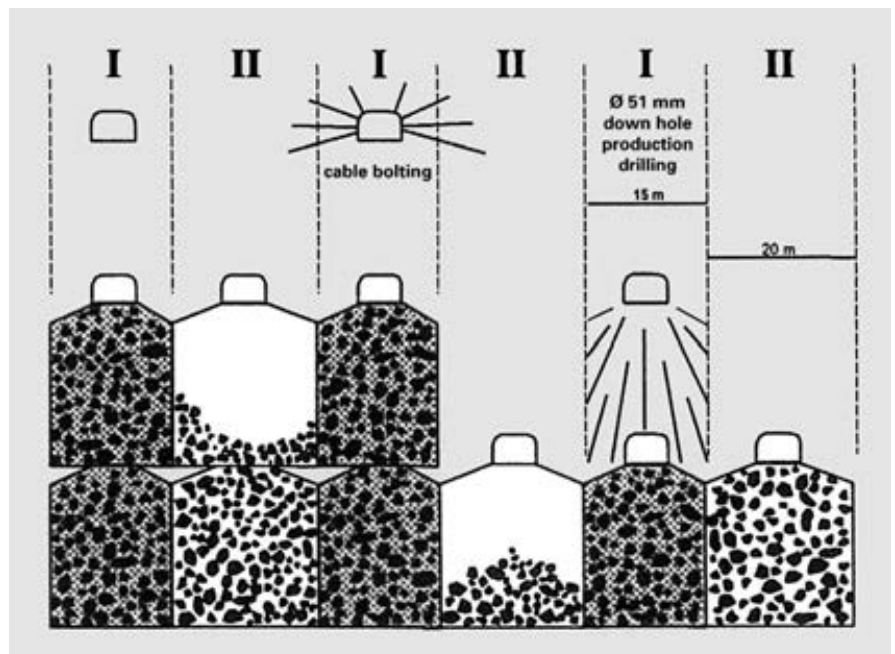



The Scooptram ST14 during tests at Kemi Mine, trams automatically between loading and dumping. The process is supervised from a remote control station.

t/y of ore, which allows for increased ferro-chrome production at Tornio when Outokumpu decides to expand the smelting operation. Budgeted cost for mine development is EUR70 million.

### Automated Scooptram ST14

In late 2007, a Scooptram ST14 loader was delivered to Kemi for use in analyzing the potential of automated back-fill

as an alternative to manual operations, particularly in hazardous environments. The operator is able to monitor every move of this advanced vehicle from the comfortable environment of the control station. He may switch over at the touch of a button from automatic to manual mode, and take control using the joysticks.

The prime reason for introduction of the Scooptram ST14 is to improve safety

by removing the operator from potential danger. However, the automated machine is also speeding up the backfilling operation, a task normally carried out by manually-driven haulage trucks.

The Scooptram ST14 is equipped with four cameras, two forward facing and two rearward facing. These are complemented by another three cameras, which are located in the drift at the loading and dumping areas. Lasers mounted either side of the machine scan the drift wall up to 35 m ahead, providing real-time data on its exact position within the drift. Coupled with an ultra-precise steering algorithm and odometer, this allows the operator to ascertain the exact location of the Scooptram within the mine complex. The algorithm controlling the interface between operator, vehicle and environment has been developed in-house by Atlas Copco, and forms a basis for further advances in this technology.

The Scooptram ST14 has been rigorously tested at Kemi in backfilling situations where it would have been impossible to use a conventional loader, and has proved its worth. The experience gained will help Atlas Copco to further develop its robust and reliable automated systems for underground use.

### Rock reinforcement

2.4 m long Swellex Mn12 bolts are used for support in ore contact formations. These are being installed at a rate of 80-120 bolts/shift using an Atlas Copco Boltec LC rig, which is returning drilling penetration rates of 3.2 to 4 m/min. The Boltec LC rig, featuring Atlas Copco Rig Control System, RCS, mounts the latest Swellex HC1 pump, for bolt inflation at 300 bar pressure, and reports progress on the operator's screen.

The HC1 hydraulic pump is robust, simple, and with low maintenance cost. Coupled to an intelligent system, it reaches the 300 bar pressure level quickly, and maintains it for the minimum time for perfect installation. Combined with the rig's RCS system, the pump can confirm the number of bolts successfully installed and warn of any problems with

A 3D impression of Kemi mine showing the open pit, the underground development and the orebodies.

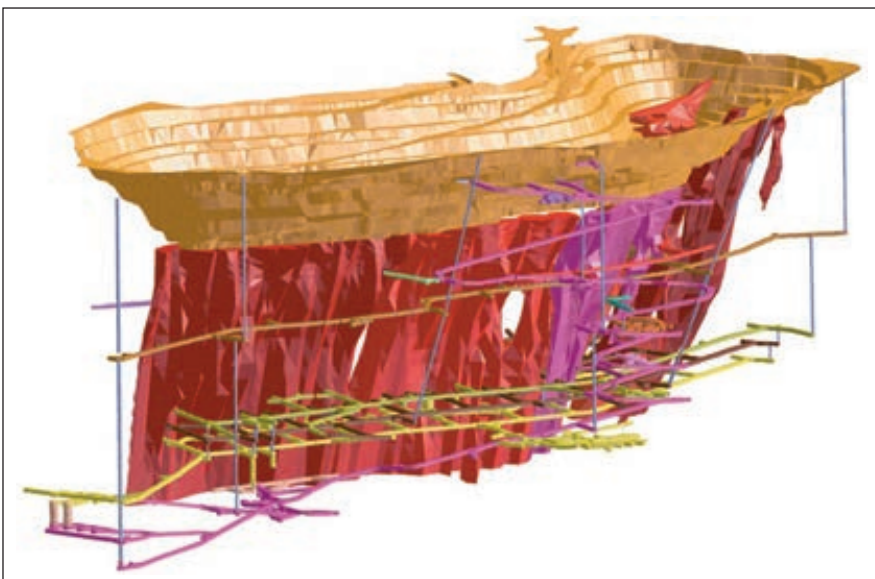



inflation. A series of slip-pull tests carried out throughout the mine proved the strong anchorage capacity of Swellex Mn12, both in the orebody and for the softer talc-carbonate and mylonite zone.

## Cable bolting

Kemi installs some 80 km of cable bolt each year using its Atlas Copco Cabletec L unit, which is based on the longhole production drilling rig Simba M7, with an added second boom for grouting and cable insertion. The Rig Control System enables the operator to pay full attention to grouting and cable insertion, while drilling of the next hole after collaring is performed automatically, including pulling the rods out of the hole. The main benefit of the two-boom concept is to drastically reduce the entire drilling and bolting cycle time. Also, separating the drilling and bolting functions prevents the risk of cement entering the rock drill, thereby reducing service and maintenance costs.

Kemi tested the prototype Cabletec L and eventually purchased the unit after minor modification proposals. During the testing period, where most holes were in the 6 to 11 m range, the rig grouted and installed cables at rates of more than 40 m/hour. The capacity of the unit, which is governed by the rate of drilling, provided around 50 per cent extra productivity compared with alternative support methods.

The Cabletec L is equipped with a COP 1838 ME hydraulic rock drill using reduced impact pressure with the R32 drill string system for 51 mm hole diameter. The machine's cable cassette has a capacity of 1,700 kg and is easy to refill, thanks to the fold-out cassette arm. It features automatic cement mixing and a silo with a capacity of 1,200 kg of dry cement, which is mixed according to a pre-programmed formula, resulting in unique quality assurance for the grouting process.

## Bench cut and fill

The current mining method is bench cut and fill, a type of sublevel stoping with downhole production drilling, in which primary stopes are 25 m high,



*Boltec LC installing Swellex Mn12 rockbolts.*

15 m wide and between 30 and 40 m long. Using a Rocket Boomer L2 C rig, the drifts for the primary stopes are developed laterally from the footwall through the ore zone. Then a Simba M6 C production rig drills down 51 mm diameter blastholes in fans 2 m apart. Each stope yields between 25,000 and 35,000 t of ore.

Tests showed that drilling upwards would be about 30 per cent more efficient, but because of safety issues related to the poor rock conditions, it was decided to start with downhole drilling while getting experience with the rock and the mining method. Meantime, Kemi ordered a Simba M7 C rig with

long boom to be delivered in August, 2005. With Simba M6 C and M7 C, operators are able to cover all kinds of drilling patterns. Mining of the 20 m wide secondary stopes started in 2005, while sublevel caving with uphole drilling was tested at one end of the main pit in 2006. Secoroc rock drilling tools are used for production drilling. The previous 64 mm holes over-fragmented the ore, but a switch to 51 mm resulted in lower specific charges and better fragmentation, while retaining the same number of holes. When developing the secondary stopes, the mine can go back to 64 mm drilling if there are problems keeping the holes open due

*Cabletec L installing cable bolts at Kemi.*





*Simba M6 C at work in the sublevels at Kemi mine.*

to the stresses and rock movements. Kemi is carrying out slot hole drilling with a truck-mounted Simba M4 C rig. The front part of the rig has been redesigned to accommodate the Secoroc COP 84L low volume DTH slobber, which is used to drill the 305 mm diameter opening hole for the longhole raises. The blasting holes are drilled off

using a COP 54 with 165 mm bit with the same tubes. The 20 m raises are blasted in two 10 m lifts.

### **Rig Remote Access**

The drill rigs at Kemi are integrated into the Ethernet WLAN communications network that eventually will cover

the whole mine. Currently, this 1 GB network, which is based on commercially available equipment, covers the declines, the workshops and parts of the production area.

This network infrastructure not only allows effective underground communication but also means that all the Atlas Copco drill rigs equipped with the Rig Remote Access (RRA) option are logically integrated into the information systems in Outokumpu's administrative organization. The RRA is installed on the Rocket Boomer and Simba rigs.

The RRA, which consists of a communication server on-board the rig and a network adapter, integrates with the mine's network to allow data transfer and remote monitoring and troubleshooting. It works as a two-way communication system, since data can be sent and received in real-time between Atlas Copco and the mine. For instance, should one of the drill rigs encounter a problem, the warning will also be seen by the operator which can then contact Atlas Copco immediately, enabling them to enter the rig's electronic system and diagnose the fault. The main benefits of RRA are: the administrative system can be updated automatically with the latest information with no manual handling; the rig operator always has access to the latest production planning; there is no need to write work reports after each shift, since all log files are automatically saved to the planning department; work orders can be issued during the shift and directed onto the specific drill rig instead of being written before each shift; and fault diagnostics can be conducted remotely, which allows the service technician to diagnose the problem and choose the correct spare parts before travelling to the drill rig.

### **Acknowledgements**

*Atlas Copco is grateful to the mine and concentrator management at Kemi for assistance in producing this article.*

*The 350 m level workshop at Kemi.*





# Mining magnesite at Jelšava

## Mechanization of overhand stoping in thick deposits

As Slovakia moved from centralized control in the early 1990s, the management of Jelsava magnesite mine faced the accumulated problems of over-exploitation and under-mechanization. In the intervening years, the mining method has been revised, the equipment inventory renewed, and the output quality improved. Despite the sometimes difficult economic situation, accompanied by political upheavals, the employee-owned company SMZ that controls the mining operation is doing well. Atlas Copco and its local distributor ISOP have been there to lend a helping hand, as a result of which Rocket Boomer drill rigs and Simba longhole drill rigs have become Jelšava's main production tools.

## Producing clinker

The fully mechanized underground mine at Jelsava, operated by SMZ, feeds high grade magnesite to on-site conversion facilities with a capacity of 370,000 t/y raw clinker. The process includes primary and secondary crushing, followed by dense medium separation to produce a concentrate for thermal treatment in shaft and rotary kilns. Electromagnetic separators differentiate magnetic brick-making clinker from non-magnetic steelmaking clinker.

SMZ's raw Jelšava clinker is converted to materials for metallurgical, ceramic and agricultural use. Annual production is around 352,000 t, comprising 167,000 t steelmaking clinker, 160,000 t of brickmaking clinker, and 25,000 t of basic monolithic refractory mixes. Overall, 85% of SMZ output is exported to 28 different countries.

To contain production costs SMZ has been investing in more cost effective mining, and plans to replace the rotary kilns with more efficient twin-shaft kilns that emit very little dust.



Map of Slovakia showing Jelšava location (Industrial Minerals).

## Geology

The Dúbrava-Miková orebody that SMZ exploits is the largest of 12 significant magnesite deposits in Slovakia. These extend from Podrečany in the west to Bankov, near Košice, in the east and were all mined for varying periods during the 20<sup>th</sup> Century. The mineralization is part of a magnesite belt extending from central Austria to the Slovakia-Ukraine border. Within Slovakia, the deposits occur mainly in the Slovenské Rudohorie mountains, and Jelšava is in the deeply dissected Revúčka highland area of this

range. The magnesite deposit extends over 325 hectares within a spur of the Magura hill mass, and the maximum altitude of this spur is 675 m asl. The underground mine is accessed laterally from portals in the sides of the spur, and mineral moves through the process plant downhill from the primary crusher, which is outside the mine on the same level as the main haulage.

The magnesite is part of a sedimentary sequence that has been subjected to tectonic forces and metamorphism, especially during the Variscan and Alpine events. This sequence, underlain by

Rocket Boomer M2 C moving towards the faces.



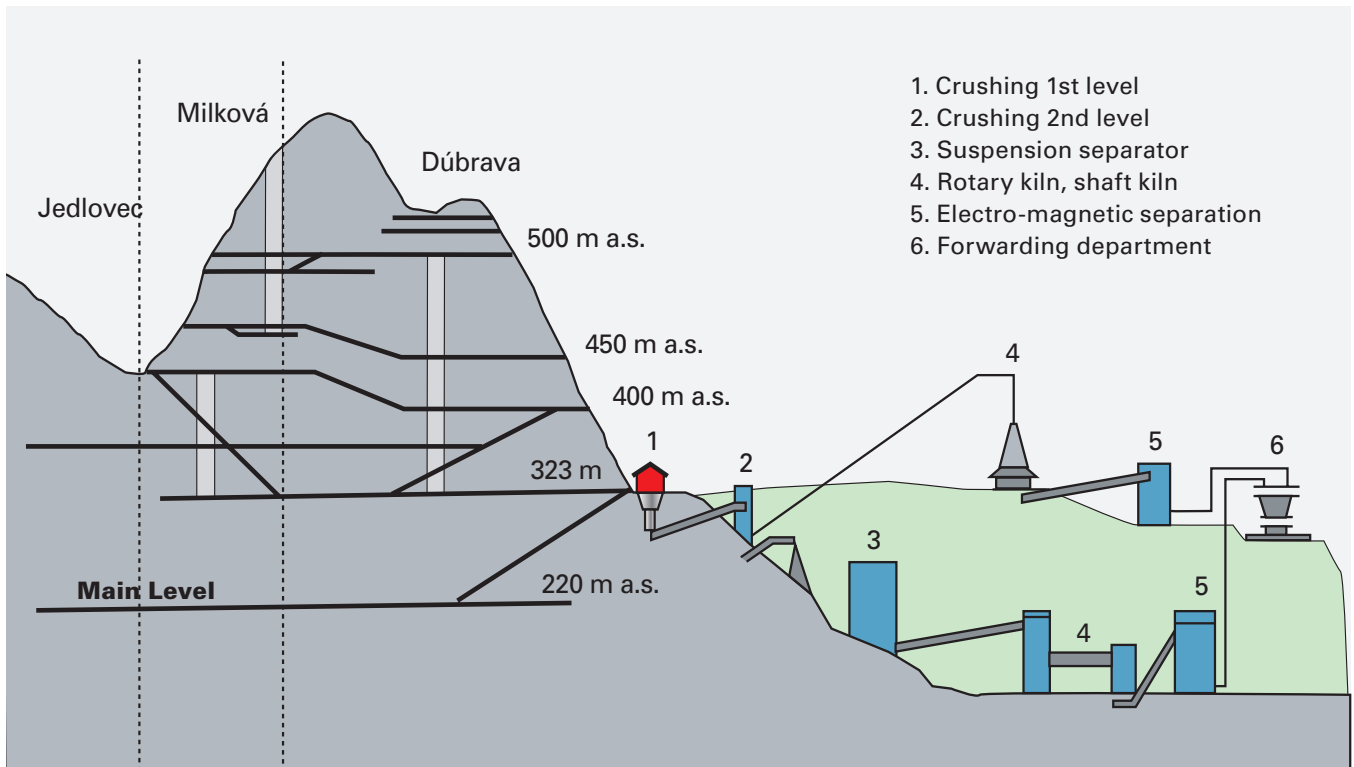

Idealised section of the mining operations and process plant at SMZ (Industrial Minerals).

diabase, comprises graphitic slate, bench-like dolomite, and the dolomite which hosts the magnesite. Graphitic slate also overlies the dolomite.

Magnesite formation has been dated at 320 million years and the mechanism is thought to have been hydrothermal alteration of a fine-grained Carboniferous limestone bioherm. The orebody is estimated to be 4,000 m-long,

1,000 m-wide and 400 m-thick, but is irregular in shape and contains cavities often filled with ochre. However, it is structurally sound, to the extent that it could be mined with pillar support and no rock reinforcement. The raw magnesite analyses 36-44% MgO, 48-50% CO<sub>2</sub>, 0.1-12% CaO, 0-2.3% SiO<sub>2</sub> and 3.2-6% Fe<sub>2</sub>O<sub>3</sub>. The specific mineralogy makes Jelšava magnesite a unique

source of ferric magnesium, this being one reason why it is imported by consumers so far away. SMZ estimates a reserve sufficient for 150 years' mining at the present production rate of 1.2 million t/y.

## Room and pillar

Around 35% of the ore is mined by the room and pillar method in blocks which are up to 100 m-long, 50 m-high and 30 m-wide, with 10 m-wide pillars along the short and long walls of the chamber, and a crown pillar at the top. Within these blocks, it is impossible to avoid mining some lower grade material, and this is stored in surface dumps.

Parallel uphole and inclined hole drilling up to 30 m was initially used for blasting the chambers, but the mine later switched to fan drilling in order to achieve better mining efficiency and safety.

This method again allows the mining of long, high blocks of magnesite up to 200 m x 300 m x 60 m, mined in up to five ascending slices.

The technique provides much greater stability in the rock mass because, not only are the rooms lower at 4.8 m to

Sequence of room and pillar mining.

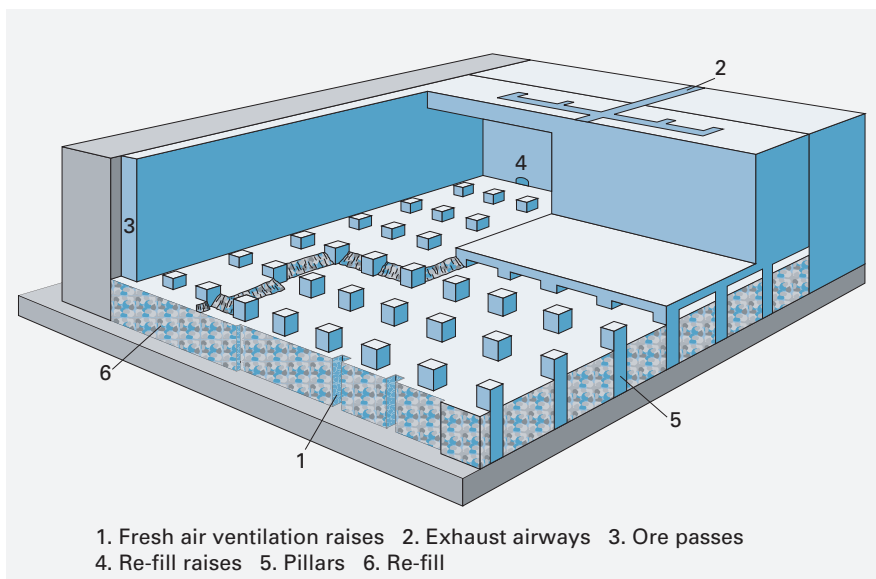

1. Fresh air ventilation raises 2. Exhaust airways 3. Ore passes  
4. Re-fill raises 5. Pillars 6. Re-fill



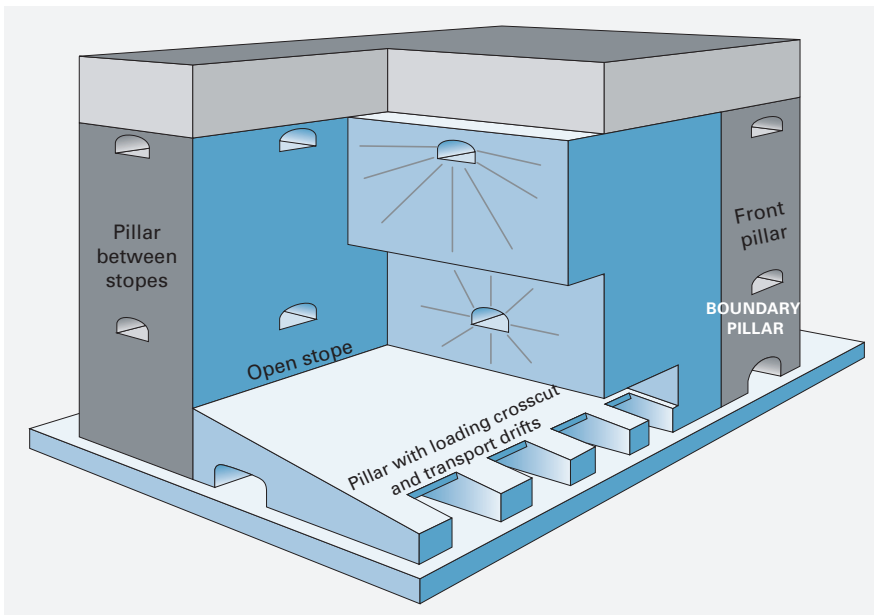

Overhand stope room and pillar system at SMZ.

5.0 m-high, but also the voids are filled, providing a bench for drilling the next slice as mining proceeds up each block. Pillars are 5 m x 5 m at 12 m spacing. The smaller rooms allow more selective mining, producing a higher proportion of processable magnesite, while the 4.4 million t of waste material dumped on surface during chamber mining can now be used as fill. The fill rate is up to 300,000 t/y.

In 1971, a new rail haulage was installed, equipped with locomotives and 20 t-capacity bottom-dump wagons. The rail system still handles ore from the core area of the mine, but it is more cost effective to use truck haulage from more peripheral parts.

## Overhand stoping

Chamber and pillar mining has created a huge void within the mine, now totaling 13 million cu m, and undercut sections of the hanging wall have collapsed in places.

Studies resulted in an overhand stoping method being introduced in some of the mining blocks above the 323 m level from 1990 onwards, and this now accounts for 65% of production.

By 1998, SMZ was looking to increase production and productivity in the overhand stoping blocks. In consultation with Atlas Copco, the mine trialed a Rocket Boomer 282 equipped with a COP 1432

rock drill. This rig achieved the expected performance improvement, and was bought by SMZ, together with a Rocket Boomer 281 and a Simba H357, for precise and rapid pillar recovery. The latter unit was equipped with a COP 1838 rock drill. Switching from pneumatic to hydraulic drilling using the two Rocket Boomers increased overhand stoping magnesite output by a factor of four.

In the overhand stoped sections muck is loaded by a fleet of three LHDs and two wheel loaders. The LHDs typically

tram to the ore passes that supply the rail haulage system, while the wheel loaders dump into trucks that may go either to the ore passes or directly to the primary crusher.

## New level development

In 2000-2001 SMZ started to develop a new mining level at 220 m asl. Whereas extraction had thus far all been above the local erosion base level, providing natural drainage at 287 m asl, this new level is below the water table. The amount of water to be pumped out is equal to the amount of ore to be extracted.

For initially driving the access ramp, and later development, plus some production drilling, Atlas Copco offered SMZ a new Rocket Boomer M2 C twin-boom rig, and helped train six Simba operators to use it.

Work on the ramp and some lateral development started in 2001 and was scheduled to take 3-4 years. The Rocket Boomer M2 C normally works either one or two of the mine's three eight-hour shifts on the ramp, but also works on production. The new level will be worked in 10 m-high slices, improving geotechnical conditions and saving on primary development costs. However, although many blocks of high quality magnesite are directly accessible using overhand stoping from the new level,

Rocket Boomer 281 drilling a crosscut entry.



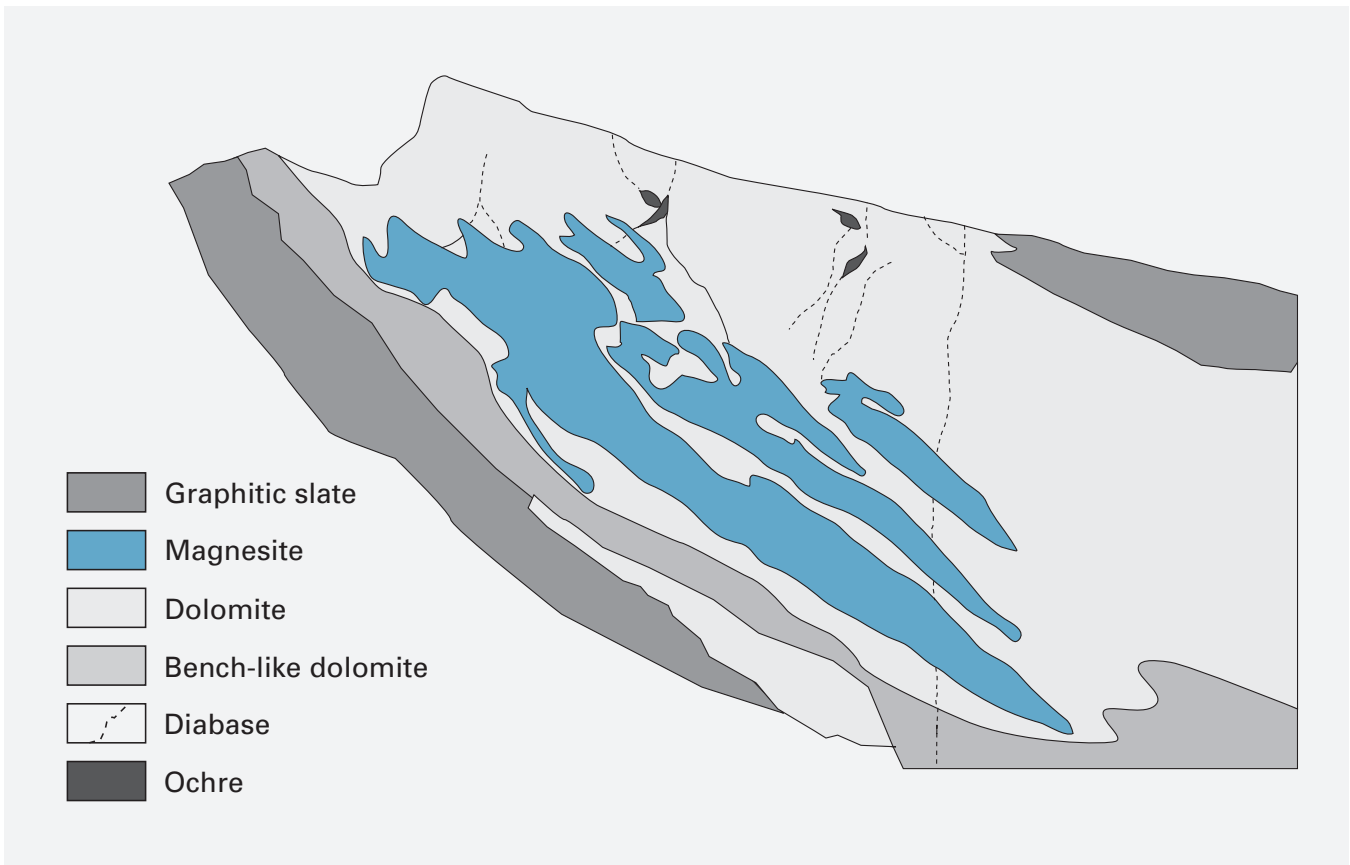

Geological section of Dúbrava Massif (Industrial Minerals).

some ore is located between access levels, some is distant from the core facilities, and some occurs as layers too thin for overhand stoping. Extraction technology for all these various sources will require new drilling, loading and hauling equipment.

Although the new mining level is below the rail haulage, and ore will probably be delivered directly to the primary crusher, SMZ expects the rail system to remain in use for another 10 years.

## Grade improvement

Secoroc equipment supplied through ISOP is used for the Atlas Copco rigs at Jelšava. Despite the very abrasive nature of the magnesite, bit life ranges from 600 m to 1,500 m. The three Rocket Boomers use 51 mm bits, and the Simba H357 drills with 64-65 mm bits. The mine does 80% of its blasting with ANFO, and uses plastic explosive for wet holes.

Of the annual mine production of 1.2 million t, around 1.16 million t is magnesite, and concentrate output is

approximately 700,000 t. Back in 2001, chamber and pillar mining supplied 430,000 t, overhand stoping 705,000 t and development 28,000 t. By 2002, 70% of drill/blast production came from overhand stoping with the Rocket Boomers, 20% from pneumatic drilling in chamber and pillar sections, and 10% from pillar recovery with the Simba H357. The improvement in average grade achieved by the more selective overhand stoping with hydraulic drills has increased the output of clinker, despite lower gross output.

## Atlas Copco representation

Atlas Copco has a Customer Center in Prague, serving the Czech Republic and adjacent countries. In 1992 ISOP, based at Zvolen in the centre of the country, was appointed as its sole distributor in Slovakia. The Rocket Boomer 282 provided for trials in 1998 was the first two boom hydraulic rig supplied to a Slovakian mine, and the Rocket Boomer M2 C was also a first.

Including the units at SMZ, ISOP presently supports nine Atlas Copco underground drill rigs in mines. Other customers include Siderit, which has two Boomer H104 drill rigs and several Atlas Copco hydraulic breakers working at its iron-manganese ore mine at Nižná Slaná, not far from Jelšava. ISOP modified these Boomer H104 rigs at the workshop in Zvolen so they could work as longhole drilling rigs. Siderit delivers ore to the US Steel plant in Košice, and to the Novy Huta works at Ostrava in the Czech Republic.

There are also six Atlas Copco surface drilling rigs in the country, five of which are DTH machines and the sixth a Coprod-fitted hydraulic rig. This latter machine yields 500,000 t/y limestone for supply to US Steel Košice.

## Acknowledgements

*Atlas Copco is grateful to the management of SMZ for its assistance with the production of this article.*



# All change for Asikoy copper mine

## Moving ore production underground

Copper has been mined for many years at the Asikoy open pit, located in Kure county, some 60-km north of Kastamonu in the western part of Turkey's Black Sea Region. Kure itself is 25 km from the Black Sea coast, and 300 km from Ankara. A major open pit operation was established in the mid-sixties, and production continues to this day. However, reserves were diminishing, and, with the available orebody extensions at depth, a plan for underground mining was evolved. This required excavation of a conveyor adit to transport rock from underground to the existing mill, and a vehicle access adit, together with a spiral ramp to the base of the known deposit. Shafts for backfill and ventilation were also needed. Production commenced in 2001, when STFA Construction and STFA Tunnelling Corporation Joint Venture took over the underground mining operation as contractor, using a fleet of Atlas Copco equipment which includes production and development drill rigs, loaders, and trucks. Monthly ore production is around 45,000 t at average grade 2% Cu, with cut-off grade of 0.5%.

## Access

The vehicle access adit is horizontal, and connects with the spiral ramp developed in the footwall of the orebody down to the sump level. The orebody, which dips at between 45 and 60 degrees, is accessed from the ramp, along levels spaced at 12 m vertical intervals.

The 20 sq m oval-plan spiral ramp was driven at 5-7 degrees from 932 m level to 792 m level by hand between 1998 and 2000 using Atlas Copco BBC 16W pneumatic rock drills with jack-legs. This work was carried out under



View of Asikoy open pit mining operation.

contract by STFA tunnelling division. Average advance was 120 m/month. The top half of each round was drilled from the levelled muckpile. The total development carried out prior to production was 1,954 m of ramp driveage, 815 m of shaft sinking, and 3,331 m of other development.

The sump at the base of the mine has 2,560 cu m capacity, and there is a natural water make of 12 lit/sec. Two vertical shafts to surface and one sublevel shaft facilitate ventilation. The exhaust shaft is equipped with a cover, which can be raised in winter to induce natural air movement.

Portal entrance to Asikoy underground mine.





## Development

An Atlas Copco Rocket Boomer 282 equipped with COP 1838ME rock drills is used to develop the ore and waste drifts.

The Rocket Boomer has one extending boom to facilitate drilling off the first rounds in strike drifts at right angles.

Drill hole diameter is 45 mm, and hole length 3.5 m. The mine has conducted trials of bits from different manufacturers, and has settled on Secoroc as the most cost-effective. Around 250 m/month of drivage is required to keep pace with the stopes, all of which are mined on the retreat.

Most development is within the competent footwall rock mass. The orebody exhibits different rock mass characteristics. Ground support is by shotcrete, bolting with mesh, mesh reinforced shotcrete, standard Swellex in 2.4 m and 3.3 m lengths, and cement grouted bolts in 3 m, 4 m and 6 m lengths. Two manually-controlled Atlas Copco Scooptram ST6C loaders are used for mucking development faces.



*Scooptram ST6C, one of three at Asikoy.*

The Rocket Boomer 282 handles all rockbolt drilling, with 37 mm holes for Swellex and 64 mm holes for grouted rebar. The mine is working with Atlas Copco to increase the use of Swellex, because of its better controllability.

## Production

The mining method is longhole bench stoping with post backfill. The ore is developed by driving strike access drifts with cross sectional area of 21.68 sq m

*Line-up of Atlas Copco equipment at Asikoy mine.*





along the footwall contact, or in the centre of the orebody. Stope preparation is carried out by driving 7 m-wide x 4.5 m-high sill drifts across the strike, to the hangingwall or footwall. These drifts vary in length, depending on the thickness of the orebody.

An Atlas Copco Simba H1254 with top hammer is used for stope drilling. Blast holes with a diameter of 76 mm are drilled downwards on several patterns, according to ore and stope type. The mine prefers downhole drilling as the most practical for their patterns, while reducing the safety risk.

At the end of the sill drifts, a 1.5 m x 1.5 m drop raise is opened by long-hole blasting, and this is widened out to create a free breaking face. Thereafter, the bench between the sill drifts is blasted towards the open slot one or two rows at a time. The main blasting agent is ANFO, which may be diluted with polystyrene beads for the profile holes, with Powergel primers and Nonel initiation. The ore is mucked from the lower sill drift using a remote controlled Atlas Copco Scooptram ST6C. After completing the extraction of the ore between the sill drifts, the open stope is backfilled to the floor level of the upper sill drift. Once two adjacent primary stopes are backfilled, the primary pillar can be mined as a secondary stope.

The production stopes can be up to 60-70 m-long, but average around 30 m-long. Currently, 8 m is left between

Production drilling with Simba H1254.

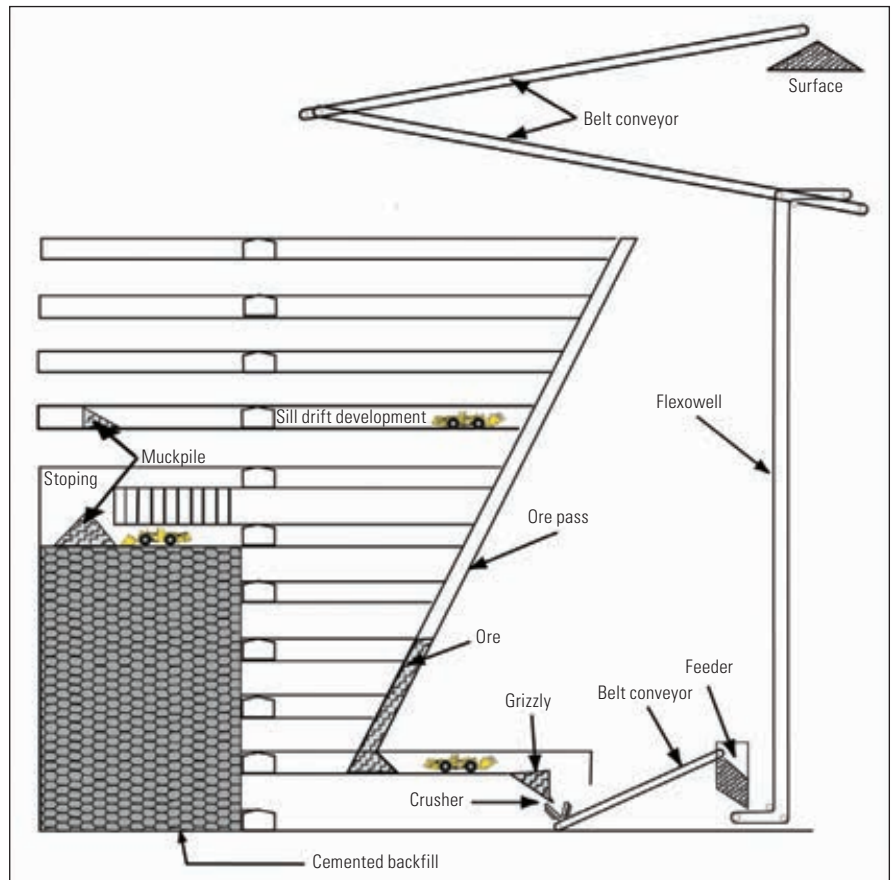

Production flow from orebody to surface.

Stoping sequence at Asikoy.

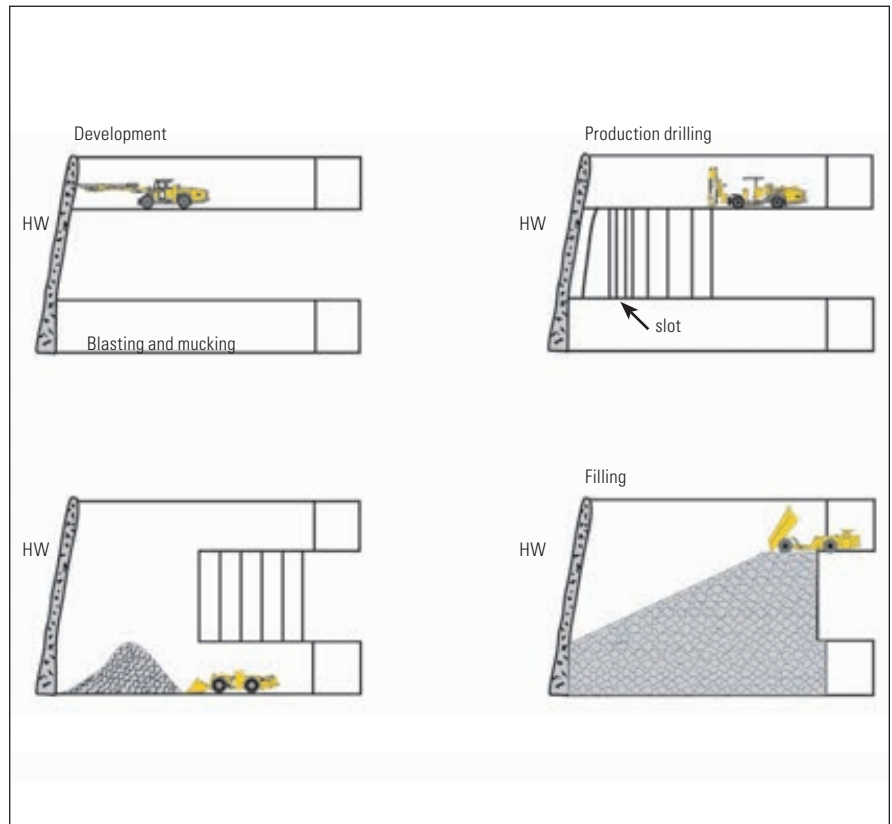



Rocket Boomer 282 on surface.



Unique Flexowell vertical conveyor installation.

sublevels, and the extraction drives are 4.5 m-high. The latest stope, which lies between 894 m and 912 m levels, has a height of 12 m, and this larger dimension will be increasingly used.

### Rock handling

The 2.5 m-diameter main orepasses are also longhole drilled using the Rocket Boomer 282, or hand drilled. An ore-pass system to the 804 level feeds the underground crusher. Crushed ore sized at -10 cm travels along a conveyor belt to a feeder, and into a Flexowell vertical conveyor belt system at 792 level. A trunk conveyor at average grade of 8 degrees transfers the ore to the surface primary crusher.

There are four vertical shafts for backfilling at Asikoy, with three sub-vertical shafts.

Two types of fill are used for backfilling. These are cemented rock fill (CRF) and uncemented waste fill (WF). CRF, with a cement content of 5% by weight, is used for backfilling of primary stopes. Secondary stopes are waste filled. Minetruck MT2000 trucks are used for both types of backfilling.

SFTA has a ten-year contract to produce 30,000 t/month of ore grading 2% copper at a fixed price per tonne, although 414,000 t was produced over the last year. The ore is concentrated to 17% at site, and is trucked to the port of Inebolu, some 25 km away, from where it is shipped to a smelter

located in Samsun, along the Black Sea coast, and to export markets.

### Training

This is the first mining operation where SFTA has been involved and, being the only Turkish-operated mechanized mine, the company takes education and training very seriously. Atlas Copco undertook the training of the mine instructors, and SFTA has carried on, giving every man on the mine specific education, each with a course every three months. The average age of operators is around 30, and most have been with the group for many years.

There are 140 men on the mine. In total, thirteen engineers have been employed for production and engineering. Atlas Copco has a maintenance contract for its equipment at the mine, and provides a workshop container manned by a fitter.

### Acknowledgements

Atlas Copco is grateful to the management of Asikoy copper mine for the opportunity to visit the project. Particular thanks are due to Kenan Ozpulat, project manager, and Serkan Yuksel, chief mine engineer, for their assistance at site and in reading draft.

Minetruck MT2000 discharges cemented backfill into a primary stope.





# Restoring profitability at Tara

## Thirty years on

Tara Mine's orebody was discovered in 1969 and production began in 1977 following extensive exploration work. The Tara Mine, the biggest zinc mining operation in Europe and the fifth largest in the world, is performing better than ever with a new management team and a healthy injection of new technology. The mine celebrated its 30th anniversary on June 4, 2007.

## Back on track

Tara Mine had been finding it difficult for many years to meet its targets. Today, however, productivity is back on track and Tara has returned to profitability.

Swedish mining company Boliden took over in January, 2004. Since then, significant improvements have been made following the introduction of revised management practices and more modern equipment.

Boliden is well known for its successful copper operations in northern Sweden, and its zinc deposit at Garpenberg in the central, south-eastern part of the country. For many years the company has co-operated closely with Atlas Copco, so when the time came to upgrade the equipment fleet at Tara, Atlas Copco was the natural choice.

The Tara fleet includes a Cabletec cable bolting rig, two Rocket Boomer M2 C drill rigs for development and three Scaletec rigs for scaling roofs and walls.

A Simba production drill rig is also on order. Added to this, Atlas Copco has provided substantial operator and maintenance training programmes for each equipment type.

## Meeting targets

Tara Mine is now meeting its target of close to 200,000 t of zinc concentrates per year and 40,000 t of lead concentrates.

All workings are underground in an area of some five square kilometres.



The Tara Mine's orebody was discovered in 1969 and production began in 1977 following extensive exploration work. The mine celebrated its 30th anniversary on June 4, 2007.

Although the central section of the mine has been largely worked out, extensions to the orebodies at Nevinstown (the upper mine) and the South-West Extension (SWEX, the lower mine), have been developed. Annual ore production is currently 2.7 Mt, with zinc and lead concentrates produced on site.

Here, as with most of Ireland, limestone and dolomitic limestone dominate the geology. The orebodies lie in the lower carboniferous limestone, which, in Ireland, is claimed to contain the highest known concentration of zinc per square kilometre anywhere in the world.

The bulk of the Tara ore dips at angles of 15–20 degrees to the south-west. Locally, the dip increases to 45 degrees and is rarely near vertical. The ore lenses are numbered from 5 (lowest) to 1 in the main orebody.

In the SWEX mine, the ore varies in thickness from as little as 3–4 m to 20–30 m. The workings are approximately 5.5 km from the entrance of the access ramp at the surface. All ore production

is conveyed to a central storage bin underground and hoisted to the surface through a 350 m deep shaft. The upper orebody lies about 50 m below the surface while the SWEX workings are about 900 m deep. Excavation is currently by long-hole drilling of open stopes through the width of the orebody, usually with their long axis parallel to the strike. This orientation reduces the amount of waste rock development required in the footwall. Additional horizontal drive access is sometimes in the hanging wall or by intermediate drives, depending on ore thickness. The footwall development drives normally run along the strike of the orebody. This gives stope lengths of up to 100 m and widths of up to 20 m while main access developments follow the dip.

Each stope is designed individually, taking account of such parameters as ore content, bedding planes, faults, joints, and adjacent openings. Stope tonnages can range from 5,000 t to more than 100,000 t. Approximately 110 separate



Atlas Copco equipment, such as this Rocket Boomer M2 C drill rig, plays a central role, pictured here with instructor Lars-Olov Jansson (left) and operator Noel Dunphy.

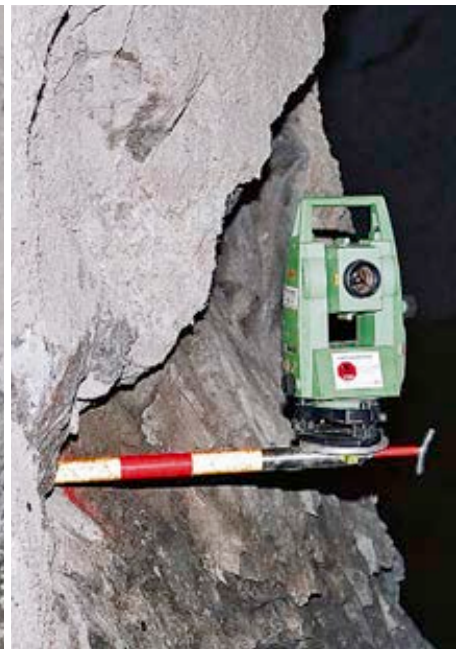

The laser theodolite survey station, the key to accurate surveying.



The Rocket Boomer M2 C console during a stope development.



Blasthole markings in stope development at a Tara face, seen from the cab of the Rocket Boomer M2 C drill rig.

stope and pillar units are brought into production each year.

### Improved morale

An important aspect of the changes taking place at Tara is the positive effect on morale. All operations are now characterized by enthusiasm and co-operation among both miners and management.

The operation is backed up by a programme of technology transfer from the Garpenberg Mine to Tara. The mine is very development-intensive, having to drive at least 13,500 m of drifts per year. This consists of some 4,000 m for

capital development, service needs and exploration drifts, and 9,500 m for stope development.

At present, the development work is split roughly 60/40 between the lower and upper mine, with one crew in each. In future, however, an even greater share of the development will take place in the lower mine. Although most of the development work is in waste rock, drifting produces about 15% of the ore production. The Tara miners are proud of their equipment, and this is reflected in the remarkable condition of some of the older drill rigs. There is a great sense of ownership of the rigs by the operators,

and high satisfaction with the enclosed cabs. Together with the improved accuracy of the Tara system and the ABC control system, this helped improve quality performance, achieving better pulls and less overbreak in drives.

The Rocket Boomer M2 C rig in the SWEX mine is equipped with the ABC Regular rig control system and is coordinated with Boliden's own survey procedure.

The drill pattern data is entered into the control system and allows the operator to accurately position and align the feeds, normally using a reference plane generated by the survey system.



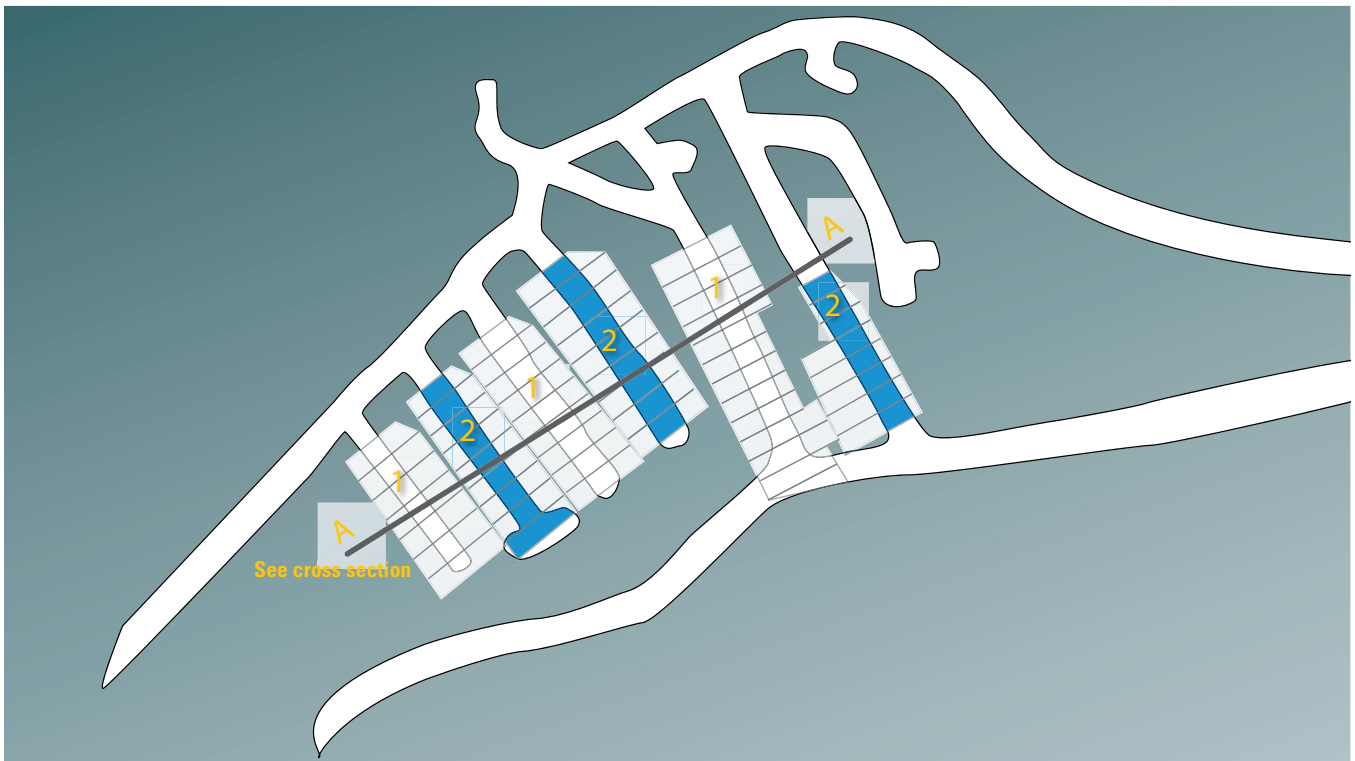

Fig 1: Plan of the 1135 level at Tara Mine. 1= primary stopes 2= secondary stopes

A common hole depth can be activated enabling all holes in the drill pattern to end up in the same vertical plane, irrespective of the starting point. This feature prevents overdrilling which saves drill metres and gives a more efficient use of the explosives. A built-in program compensates for any mechanical deflection of the booms.

Depending on the application area, the rig drills holes up to 5.4 m long. Drift sections vary from 4.5 m wide x 4.2 m high to 5.5 m wide x 5.5 m high. The blasthole diameter is 45 mm and 57 holes are normally drilled. In the centre, there are four relief holes, 102 mm in diameter. The holes are blasted using bulk emulsion explosive with Nonel detonators. A round with 4.9 m hole depth gives a pull of 4.7 m.

Of the two Rocket Boomer M2 C rigs delivered in 2006, one uses 16 ft (4.88 m) rods and the other uses 18 ft (5.59 m) rods. A third rig will also use 16 ft rods, and all rigs are equipped with BUT 32 booms.

## Streamlined surveying

The mine's survey department carries out all surveys of drifts in three planes

(x, y and z co-ordinates) in conjunction with mine planning engineers. This procedure has been developed by Tara using Boliden's Eagle system and streamlines the transfer of planning co-ordinates to the rig's programming card, in a similar way to Atlas Copco's Tunnel Manager. Together with the use of a laser reference and the ABC control system on the drill rigs, the method eliminates conventional surveying in order to obtain a clear, easy survey line-of-sight where drives do not follow a straight, horizontal path. It also eliminates the need for frequent survey checks. The direction of each drift is fixed according to the mine grid azimuth, and co-ordinates are needed for every change in level. If the beam from the laser-theodolite at the reference point hits the back of the face, this eliminates the frequent pegs used in conventional surveying as the face is advanced. This distance value is entered into the Boomer controls so that the on-board computer can calculate exactly where the rig is to be set up.

The system enables the operator to become an integral part of the survey and drift process. All the miner needs to know is the distance from the laser and the rig's program in order to drill

the required drill pattern with accurate offsets. Line, grade and overbreak are achieved much better than before.

## Mechanized scaling

In keeping with Tara's emphasis on safety in all procedures, scaling now takes place after every blast. The three Atlas Copco Scaletec scaling rigs are more compact and easier to operate than their predecessors.

Scaletec machines equipped with Atlas Copco SB 300 scaling hammers are working on a three-shift cycle. In the development cycle, scaling takes place immediately after mucking out and before any necessary ground support. The rigs are integrated into the development cycle to speed it up, but they also scale other areas which are not shotcreted, such as high-stress areas, before they come into production.

## Simba on the way

The first Atlas Copco Simba production drill rig is soon to join the Tara fleet following its success at the Garpenberg Mine in Sweden. Also featuring the Rig Control System (RCS), the rig simplifies

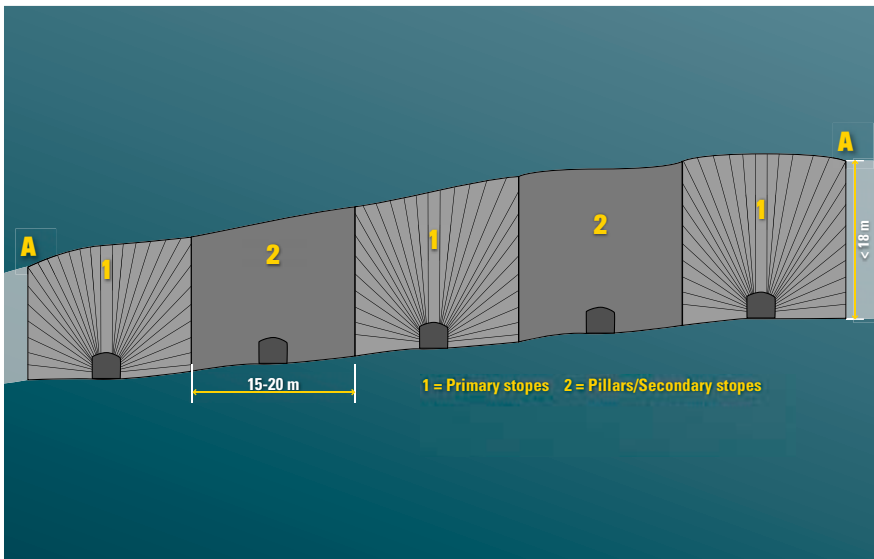

Fig 2: Cross section A–A showing the blasthole drilling pattern at SWEX and stope-pillar geometry.

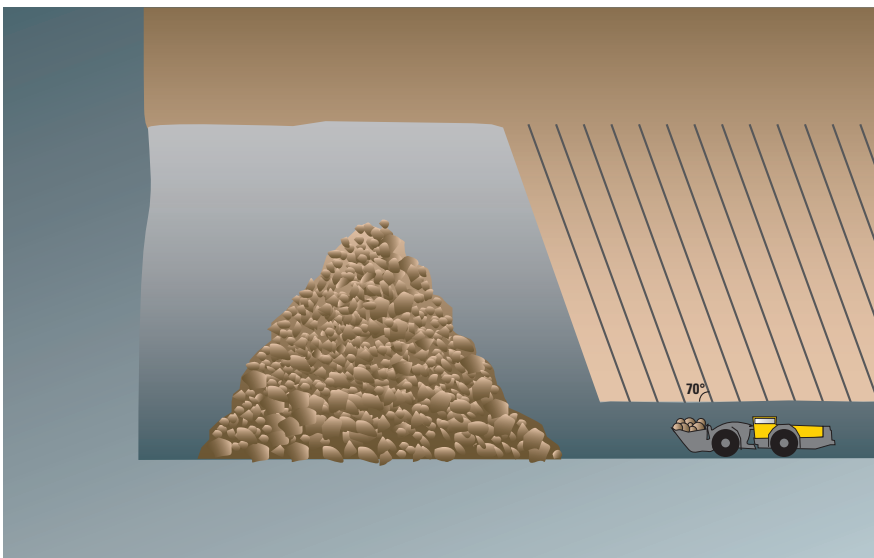

Fig 3: Long section showing the drilling pattern of the blasthole fans and mucking.

accurate set-up, enabling the operator to fix the rig position with two survey reference points.

This special feature is called Mine Navigation, (MN). It was specially developed for Boliden's Simba M7 rigs but is now available as an option for all Simba models.

The drill pattern is stored on board the rig and automatically transferred to its controls. Fans of 64- or 70 mm diameter holes, 2.2–2.5 m apart, are drilled at a 70 degree angle with toe spacing of 2.4 m. Stopes in the SWEX mine are normally 17–18 m wide, up to a maximum of 20 m. Two to four drilled rings provide around 5,000 t of ore from each

round. The pillars between filled stopes are mined, so accuracy in the development drives and the production drill pattern is essential. Also, some of the most valuable ore material is at the top of the drill ring under the hanging wall, therefore hole position at this area is important.

Stope and development drilling is crucial, and approximately 400,000 m of longhole drilling is carried out each year.

Alternating, sequential stoping is used with backfilling of the first open stopes and settlement, prior to mining the remaining pillars. Some permanent pillars are left at strategic locations. A

relief slot is excavated at the end of each stope development drift and the ore is progressively blasted and mucked out (Figure 3).

In the event of the ore exceeding a vertical thickness of 25 m, intermediate and/or hangingwall access drifts will also be developed.

## Ground control with Cabletec

Reliable ground control, in which cable-bolting, including an Atlas Copco Cabletec rig, plays an important part, is vital for both safety and optimum ore recovery.

The separate grouting boom of the Cabletec is a very attractive feature as two operations can carry on simultaneously. This has produced 50% more productivity from the Cabletec compared to earlier machines.

A bulk cement handling system helps keep cement dust away from the operators. A 30 t silo stores the dry mixture, with the required amount carried to the cable-bolting rig in an Atlas Copco-designed mobile silo, the CS 22.

The support required is calculated according to gravity loading, the density of the rocks, and strength of the cable. Normal bolting spacing is the same as the blasthole fan spacing, but if the roof conditions require it, they do more. Pyrite and boulder conglomerates, with lumps 3 cm to 3–4 m in a mudstone matrix, can make ground conditions difficult in the hangingwall. The exposed pyrite in the conglomerate, with up to 40% iron content, has to be mined as soon as possible.

## Automatic grouting

The mine is doing away with manual handling of cement for safety and efficiency. The grout tank is delivered to the site and loaded up by forklift and the Cabletec carries enough grout on board for a whole shift.

The grout mix has to be fluid enough to be pumped into the hole but rigid enough to remain in it and hold the cable whilst curing. There is sufficient hose on board to pump grout to the end of a 25 m-hole, which meets all of Tara's needs.



*The mine's Cabletec in action.*

Cablebolting is generally carried out as an independent operation after production drilling. Tara uses more than 6,500 m of cable each month, or some 70 km/y. Each cable bolt hole is 15–25 m long and 51 mm in diameter.

A double strand of cable is inserted which offers a loading capacity of 50 t/strand. Where required it takes about 1,500 m of cable per stope to support the hanging wall.

With this amount of cable, other major advantages of the Cabletec come into play. The rig has an onboard storage capacity of 1,700 m of cable compared to the 700 m capacity of the previous rig.

The cable is easily loaded, as it is supplied on a reel that is brought to the rig by forklift truck and loaded automatically without any manual handling.

The filling of mined stopes required to support mining of adjacent pillars is also a crucial operation in the support of the whole mine. For the primary stopes, the sand/cement ratio varies from 15:1 to 25:1 depending on requirements. Two months are required for settlement in the

stope and curing before the adjacent pillars can be mined. Sufficient compressive strength is achieved after 56 days with a 15:1 sand/cement ratio. Then, in order to prevent subsidence, the open pillar stopes that are not required for mine support are filled with low cement ratio, classified tailings.

The introduction of some new methods, along with the purchase of new equipment, has required training for both safety and efficiency.

Many of Tara's operators have also visited the Atlas Copco facility in Örebro where they had the opportunity to familiarize themselves with the new units, prior to delivery at the mine. For example, prior to the delivery of the Scaletec rigs, Atlas Copco trained six Scaletec operators for Tara during a five-day programme, followed by a course for Tara service technicians.

## Service and support

Apart from the commissioning and introduction of new equipment, all servicing is undertaken by Tara's own staff

alongside an Atlas Copco Service Supervisor. This is coupled with support from the local Atlas Copco depot and Atlas Copco in the UK, as required.

The mine operates a planned preventative maintenance programme to minimize equipment downtime and the engineering maintenance departments carry out all normal maintenance and repairs.

Weekly inspections and most other routine servicing are carried out at the worksite, but for major services requiring a crane, for example, the equipment is brought into the underground workshop, 430 m below the surface.

Around 300 miners and supervisors are at work underground in two 10½ h shifts/day, 08:00 to 18:30, Monday to Saturday. This gives 11 shifts (six days and five nights) on a three-week rotation basis which means that the miners get a week off every third week. In addition, more than 100 support personnel work both underground and on the surface.

Tara's excellent safety record, with greatly reduced accidents since 1999, has resulted in a "Level 7" rating in the



International Safety Rating System. The mine aims to achieve OHSAS 18001 certification by the end of 2008, and all employees are scheduled to attend monthly safety meetings. Added to this there is a strict and comprehensive planning and environmental policy in place as well as a department dedicated to environmental monitoring and control.

Current reserves, production rates and metal prices set the life of the mine to at least 2016 – although exploration for further extension of the SWEX ore-body continues. With the current working atmosphere, high demand for its products, and new Atlas Copco equipment, few would bet against Tara’s continuing success.

## Acknowledgements

*Atlas Copco is grateful to the management at Tara Mine for their assistance in the production of this article.*



From left, Patrick White, Mine Captain, Derek Douglas, Cabletec operator and Benson Plunkett, Senior Operations Engineer, in front of the Cabletec rig.



## Place of great prospect

Tara Hill, in the Boyne Valley, County Meath, is one of Ireland’s most historical sites. Appropriately, its ancient name is said to mean “Place of Great Prospect”. The area is covered in many mysterious stones dating back thousands of years, one of which is the famous “Lia Fáil, the Stone of Destiny”. This 1.5 m high column of granite is believed to mark the coronation site of the High Kings of Ireland. Legend has it that when a true king touches the stone, the power is so great that it gives off a terrifying roar that echoes across the valley.

*Mythology meets modern mining: this mysterious monument is thought to be 5,000 years old.*



# Mining challenge at El Soldado

## Integrated operation

El Soldado is a tightly integrated operation consisting of an underground and open pit copper mine, a concentrator and an oxide plant. In order to increase production underground, El Soldado introduced a variation to its standard sublevel open stoping mining method in 1983. Six years later, the open pit section of the mine was started, posing an additional complication for the geotechnical and mine design teams. These days, the engineers enjoy the challenge of an underground mine, which features a complex layout and problematic rock conditions with numerous open cavities, irregular orebodies of variable dimensions and in situ stresses that vary in magnitude as well as in orientation. Extraction of the reserves must also follow a sequence that minimizes impacts on the overlying surface operations. A committed user of Atlas Copco drill rigs, the mine depends upon Rocket Boomer M2 Cs for development and Simba M6 Cs for production, all featuring a high level of computerization.

## History

The El Soldado and Los Bronces copper mines and the Chagres smelter, all located in Chile, are operated by Compañía Minera Disputada de las Condes.

In addition to its record as a successful mining company, Disputada's operations achieved recognition in 1999 when it became the first industrial company to receive Chile's National Environment Award, recognizing its leadership in environmental practices and its high standards in environmental management.

Disputada produces around 250,000 t/year of copper. When, in 2002, Anglo American plc agreed to purchase Disputada from Exxon Mobil, it substantially enhanced the quality of its base metals portfolio, in addition to offering significant synergies with its other Chilean copper operations, the Doña



Atlas Copco ROC L8 crawlers at El Soldado open pit.

Inés de Collahuasi and Mantos Blancos mines.

El Soldado mine is located 132 km northwest of Santiago, on the western slopes of the Coastal range, at about 830 m asl. El Soldado produces around 64,000 t copper in concentrate and 5,000 t copper cathode, and its reserves are estimated to be 115 million t grading 1.0% copper.

The total workforce of El Soldado is under 280 people, of which one third are employed in the underground mine.

Of these, 24 technicians are employed in maintenance. The mine operates Monday to Friday in three shifts of 8 h.

Mining at El Soldado started in 1842. Since 1978, when Exxon Minerals acquired the operation, about 70 million t of ore containing 1.8% copper have been mined by the underground sublevel open stoping method. In 1989, the El Morro open pit commenced production to increase output to the present 18,000 t/day. Today, the underground mine provides less than 30% of the

El Soldado location in central Chile.



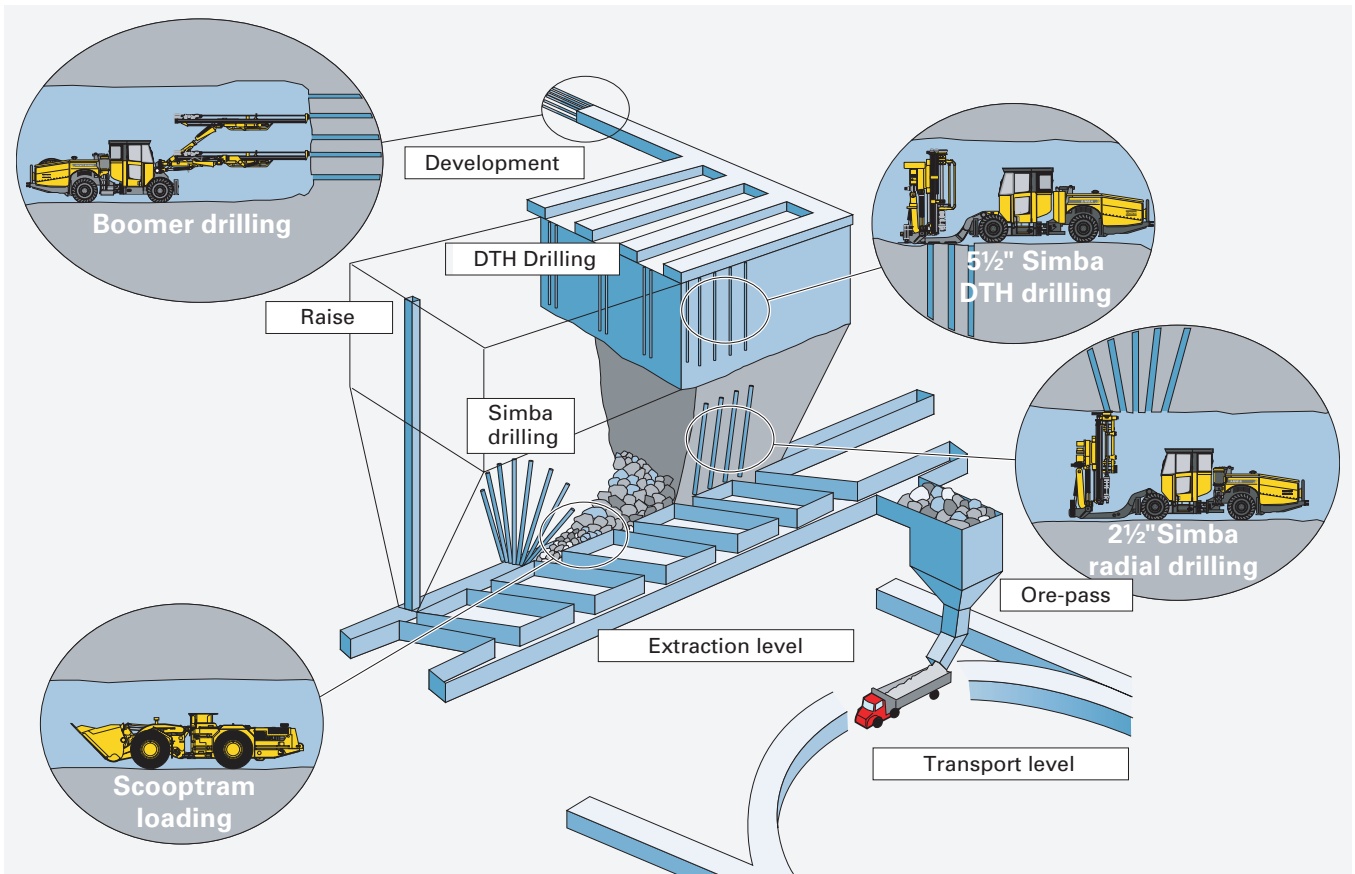

El Soldado underground mining schematic overview.

total concentrator feed, but rather more of the contained copper.

The sulphide plant's current capacity is 6.5 million t/year, of which the underground mine supplied 2 million t in 2006. This is expected to decrease to 1.6 million t in 2007 as open pit output increases.

### Problematical geology

The El Soldado deposit is located in the Lower Cretaceous Lo Prado formation, and is thought to be of epigenetic origin. The main host rocks are trachytes, followed in importance by andesites and tuffs. Copper mineralization occurs as

numerous isolated orebodies, with a strong structural control, located throughout an area 1,800 m-long by 800 m-wide. The lateral limits of the orebodies are characterized by abrupt variations in the copper grade. The transition from high-grade mineralization of 1.2% to 2% Cu to low grade areas of 0.5%

Section of El Soldado mine and plant process.

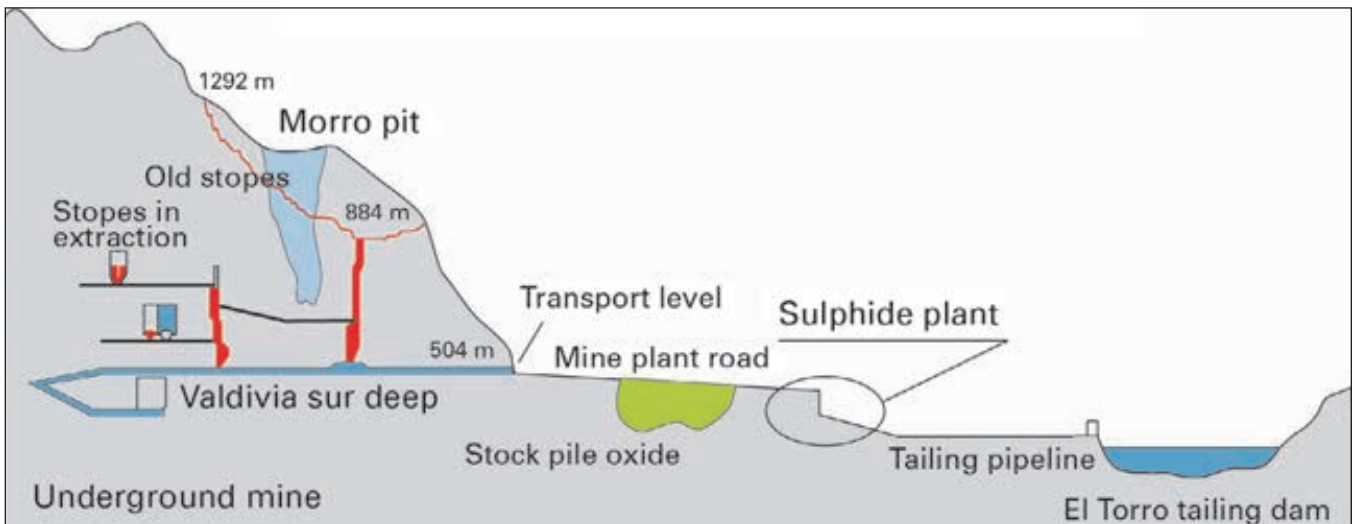

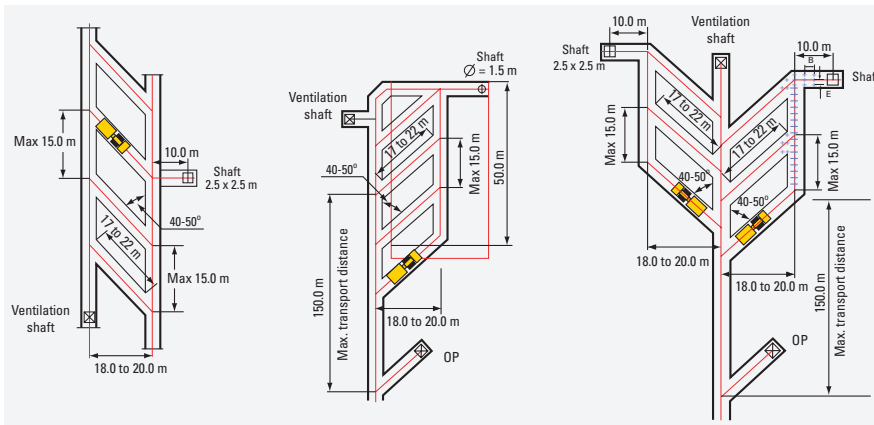

Extraction level layout.

to 1.2% Cu takes place within a few metres. Orebodies typically exhibit an outer pyrite-rich halo, followed inwards by an abundant chalcopyrite and bornite core, with minor chalcocite and hematite. The main gangue minerals are calcite, quartz, chlorite, epidote and albite.

The orebodies are of tabular shape, with dimensions that vary from 100 to 200 m in length, 30 to 150 m in width, and 80 to 350 m in height. The ground conditions are classified as competent, with an intact rock strength greater than 200 Mpa, in a moderate stress regime ranging from 15 to 30 Mpa. These geotechnical conditions facilitate the development of large open cavities, normally as large as the orebodies, with dimensions from 40 to 90 m width, 50 to 290 m length, and up to 300 m height.

The nature of the major structures, and the inherent condition of the rock mass, play a critical role in determining the extent of any likely instability surrounding excavations at El Soldado mine. Seven main fault systems, and a system of bed contacts, have been defined within the ore deposit limits as being significant in geotechnical terms. The induced state of stress after excavation is a significant mine design criteria, and a monitoring objective. In an attempt to obtain information on the in-situ stress in critical areas of the mine, measurements have been carried out.

## Mine stability

Mine stability is a matter of prime importance in the planning process, particularly as the El Morro open pit is situated

immediately above the underground mine. An integral mine plan is therefore required, in which the sequence of extraction, both in the open pit and underground, needs to satisfy safety and efficiency criteria. In particular, the design and extraction sequence of underground stopes have to be managed in such a way that they do not affect the open pit operations, and minimize disturbance to unmined areas, enabling maximum resource recovery. This has to be balanced with the need to maintain high-grade feed, and the selectivity that comes with underground mining. There has been a large amount of development in the underground mine, creating a large number of stopes, and a complex layout.

Because of all the aspects that need to be taken into account before mining can start, extensive geotechnical monitoring is applied to rock conditions, to detect and identify failures and instabilities, to collect data for mine planning and stope design, and for ongoing assessment of mine stability. Over the longer term, the collected data provides control points to update the geotechnical database, and to verify the assumptions made in the design.

## Underground layout

The access points to the orebodies are located on the slope of the Chilean coastal range hosting the mine, several

Rocket Boomer M2 C underground.



Surface workshop at El Soldado.



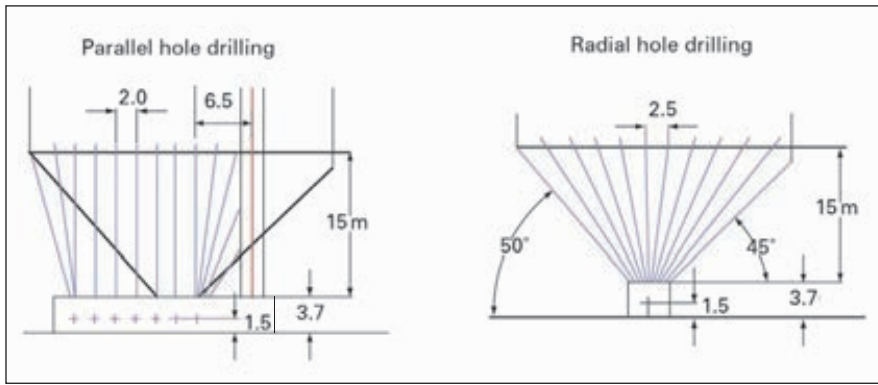

*Uphole production drilling pattern.*

hundred metres above the valley floor. Today, the main entry is located at -100 level (730 m asl) and the haulage level is at 300 m below datum (530 m asl). The mine has been developed by a network of sublevels, providing access to the tops and bottoms of the mining areas. Sublevels are linked by ramps, with a maximum slope of 15%. Ore is loaded directly into ore passes with an overall capacity of 10,000 to 30,000 t, which connect sublevels with the haulage level. This ore is transported to a crusher located on surface, near the concentrator, using 50 t-capacity, highway-type trucks. Some ore is mined below the main haulage level, and this material is transported directly to the surface crusher using trucks and ramps.

Historically, the massive, but irregular, orebodies and the competent ground conditions made sublevel open stoping the preferred mining method. However, in 1983, fully mechanized sublevel and large-diameter blast hole open stope (SBOS) was introduced as a variation of the standard method, enabling an

increase in production rates. Nominal stope dimensions are 30 to 60 m-wide, 50 to 100 m-long, and up to 100 m-high, though large orebodies are divided into several units, leaving rib and crown pillars as temporary support structures. Rib pillars are 30 to 50 m-wide, and crown pillars 25 to 40 m-thick. The stopes are mined progressively downwards by a traditional SBOS method, and are left unfilled. Pillars are subsequently recovered by a mass blast technique, and are sometimes designed to break more than 1 million t of ore each.

The rock is very competent, and the stope cavities can be left open, sometimes standing for 5 or 10 years, depending on the sector and the rock structure. Smaller stope cavities normally have stable geometries, with less than 5% dilution from back extension or wall failure. However, three large open stopes, the Santa Clara, California and Valdivia Sur stopes, have experienced controlled structural caving, filling the existing void and breaking through to

the surface. If it is decided to fill a stope, then waste rock from development is used.

## Production stopes

Production block access is provided by developing sublevels, with a pattern of 5.0 m x 3.7 m LHD drawpoints at the base of the stope. Block undercutting is accomplished with a fan pattern of 60 to 75 mm-diameter holes up to 25 m-long loaded with ANFO and HE boosters. Slots are made by enlarging a 2.5 x 2.5 m blast hole slot raise, at one end, or in the middle, of the stope. Blast holes of 165 mm-diameter and up to 80 m-long are drilled with an underhand pattern. Blast size and blasting sequence is defined for each stope, according to major structural features and the proximity of existing cavities. Dilution control is improved, and blast hole losses avoided, by carefully considering the particular geometries created by the intersection of major discontinuities and the free faces of the planned excavation. Often, faults present geometries which generate wedges that can slide into the cavity, affecting fragmentation and generating oversize rock at drawpoints. The presence of cavities, or simultaneous mining in nearby locations, also impose restrictions in the mining sequence and size of blast.

Production ore from stopes is loaded out with 10 cu yd LHDs. One-way distances of 100 to 150 m are maintained to orepass tips, which are not equipped with grizzlies as oversize rock is drilled and blasted in place at the drawpoints. Orepasses terminate in hydraulically-controlled chutes at the -300 haulage level, where the 50 t trucks are loaded with run-of-mine ore or development waste.

A square pattern of 1.90 m x 1.7 m split set bolts, 2.05 m-long, in combination with wire mesh, is used to maintain working areas free of rock fall, and to protect personnel and equipment. This approach to ground control is not intended for heavy rock loads or massive stress-induced instabilities, though is adequate for local support. Where needed, cable bolting is used to support unfavourable geometries, such as large wedges or low dip bedding layers,

*Downhole production drilling pattern.*

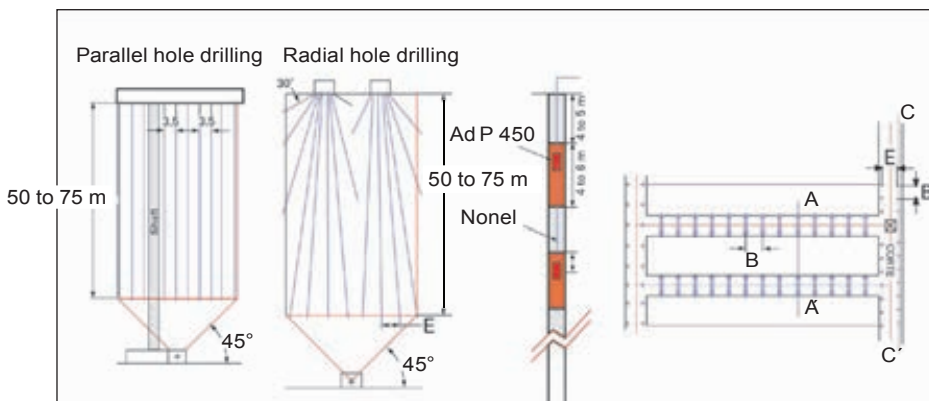





*Simba M6 C drilling radial holes.*

and also to support drawpoints and ore passes where the rock conditions have changed dramatically. Occasionally, cable bolts are used to minimize or prevent caving in the sublevel stopes.

Development headings average 18.5 sq m cross section, in which the introduction of the Rocket Boomer M2 Cs has increased the incremental advance from 3.9 to 4.2 m/round. The number of holes/round has meanwhile been decreased by changing from 45 mm to 51 mm-diameter bits and a 5 in cut hole.

Large-diameter blast hole open stoping has worked well at El Soldado. The mine drills up to 53,000 m/year using DTH, and 32,000 m/year with top-hammer drilling. The current method allows the exploitation of larger units, reducing preparation costs and improving productivity costs. Another advantage of the method is that it is selective, allowing extraction of only the mineral. The current cost distribution is: development 32%; service and other 28%; drilling and blasting 17%; extraction 12%; and transport 11%.

## Equipment maintenance

El Soldado has been through a phase of equipment replacement. Two of the

three Atlas Copco Boomer H127s equipped with COP 1032 rock drills have been replaced by new Rocket Boomer M2 C units featuring Advanced Boom Control (ABC) system. These work alongside the remaining Boomer H127 unit drilling 43 mm holes. The old machines have been rebuilt, one as a secondary drill rig, and the other as a scaler.

For production, El Soldado employs three Atlas Copco Simba 264 rigs equipped with the COP 64 DTH rock drill for 5.5 in holes. There are also an Atlas Copco Simba H221 and a Simba H252, both used for radial drilling of DTH holes ranging between 65-75 mm. The Simba H252 drills the 75 mm-diameter upholes for the undercut.

The Simba 264 machines are being replaced by the new generation Simba M6 C DTH drill rigs, which along with the Rocket Boomer M2 C units, feature the ABC Regular, which will be upgraded to ABC Total in due course.

El Soldado obtains 20% to 30% more drilling capacity per hour with the new Simba M6 C machines, on account of mechanized tube handling and better control of drilling parameters.

The robust design offers better utilization and lower maintenance. Three PT-61 ANFO chargers, built on Atlas

Copco DC carriers in co-operation with Dyno Nobel, are used for both face and long hole charging. A fourth unit, a Rocmec DC 11 built on an Atlas Copco carrier, is equipped with an Atlas Copco GA 11 compressor and an ANOL CC type of charging vessel.

For loading and transportation, three Atlas Copco Scooptram ST8B loaders are employed. The mine also has three 13 cu yd Scooptram ST1810 loaders equipped with monitoring systems which are employed on waste haulage.

Rock reinforcement is carried out with an Atlas Copco Boltec H335 bolting machine.

El Soldado has installed a computer-based system to monitor the condition of its mobile equipment. The underground leaky feeder communication system is linked to the loaders and drill rigs.

Both the open pit and the underground areas have equipment maintenance workshops. A preventive maintenance workshop located on the surface further serves the underground area, and field maintenance is carried out on the Simbas.

## Outlook

El Soldado's main objective is to continue with its tradition of excellence in safety and cost competitiveness. The underground mine production is being reduced as open pit output increases, and variants of the exploitation method will be introduced to recover minor volume reserves using automated radial drilling to over 40 m depth.

El Soldado's mining plan is intrinsically linked to its geotechnical and geometric conditions, and so improvements to the monitoring and data-collection systems, in order to obtain more precise geotechnical engineering, are constantly being studied.

## Acknowledgements

*This article is based on interviews with Nelson Torres, Mine Superintendent at El Soldado, and extracts from the following paper: Contador N and Glavic M, Sublevel Open Stoping at El Soldado Mine: A Geomechanical Challenge.*



# Pioneering mass caving at El Teniente

## Mining in primary rock

One of the five mining divisions of the Corporación Nacional del Cobre de Chile, Codelco, El Teniente is an integrated copper operation comprising mine, concentrator and smelter installations. Faced with the depletion of its reserves of high-grade secondary mineralization, the division has completed the change to mining in primary rock. The early years were traumatic, with major geotechnical problems including a series of fatal rockbursts and the collapse of significant areas of the production levels. However, El Teniente rose to the challenge and, following an extended period of study and trial mining, is successfully using a variation of the Panel Caving method in the new Esmeralda Sector. This method is now being applied to future development plans for the New Mine Level project, which starts production in 2014.

## Largest copper producer

Owned by the Chilean state, Codelco is the world's largest copper producer. It produces more than 1.5 million metric fine tonnes (mft) of copper/year, representing 16% of western world production. In addition, Codelco is the world's second largest molybdenum producer, with an output of around 25,000 t/y. The corporation's other competitive strengths are its cost efficiency of around 40 US cents/pound and its reserves, which comprise about 21% of the world's total, and are sufficient for more than 70 years of mining at current production levels.

Codelco operates five mining divisions at Chuquicamata, Radomiro Tomic, Salvador, Andina and El Teniente, and a service division located at Talleres Rancagua. It also participates in other mines, including El Abra, and also has several joint ventures involved in

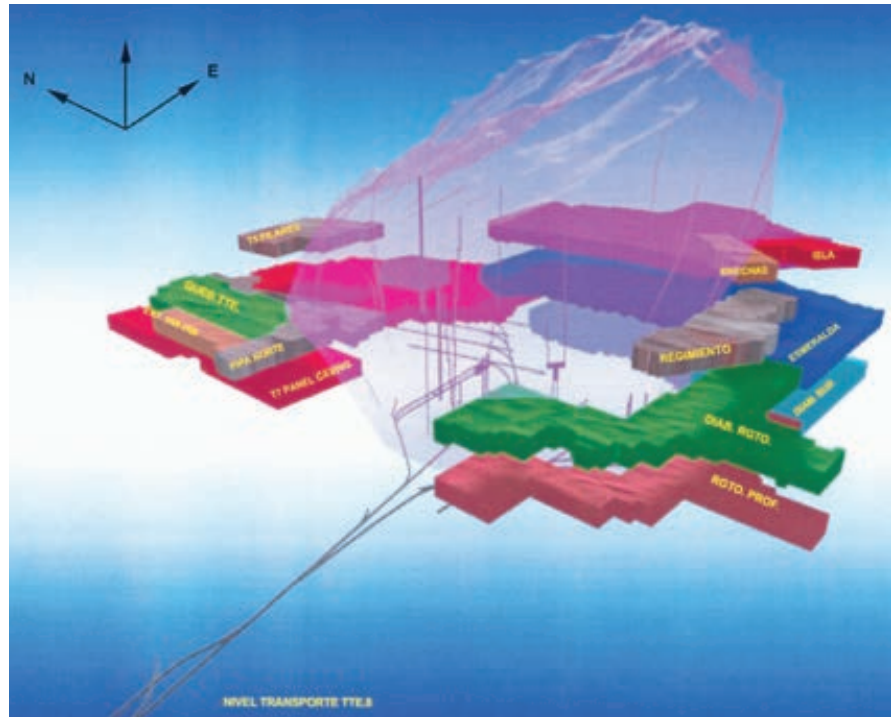

Isometric representation of El Teniente mining sectors.

geological exploration and different associations in new business.

The company's vision of the future aims to consolidate its leadership of the world copper industry in terms of competitiveness and operating excellence, thus reinforcing its position in the global economy. In line with this, Codelco set itself the goal of doubling its value to some US\$18 billion by 2006, through higher productivity, market development and synergies. Achieving this depended, amongst other factors, on the successful and opportune implementation of the US\$4.3 billion investment contemplated in the company six-year strategic plan.

## El Teniente

El Teniente is the world's largest underground mine, with over 2,400 km of development to date. The mine is located at 2,200 m asl, some 80 km south of the capital city of Santiago. The total

geological resource at El Teniente above 1,720 m asl is over 10 billion t at 0.65% copper, and the mining reserves above 1,980 m asl and 0.6% copper cut-off grade are over 3 billion t at 1.0% copper. El Teniente produces anodes, refined copper, electro-won cathodes and molybdenum concentrate, all of which is shipped out through the Port of San Antonio.

Currently, El Teniente Division employs 5,219 workers, a decrease of 22% from the 6,652 it employed in 1996. During the same period, the total accident rate was reduced over 50%, while the cost of production was reduced by more than 10 US cents/pound. In terms of productivity, each employee currently achieves 71 t/y of copper, an increase of 25% since 1996.

## History

According to legend, El Teniente was discovered by a fugitive Spanish official

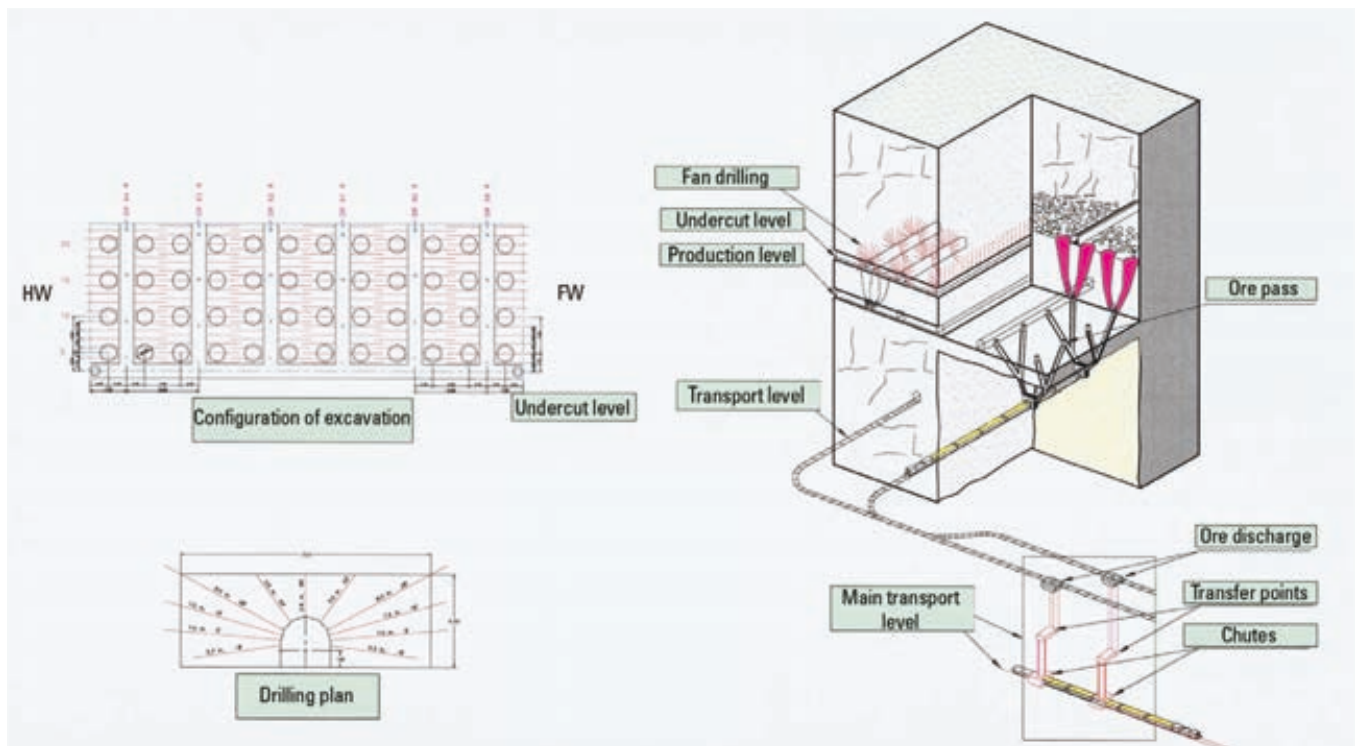

Traditional block caving layout.

in the 1800s. Exploitation first began in 1819, when the highest-grade minerals, from what became the Fortuna sector, were mined manually and transported on animals to the coast. In 1904, William Braden, an American engineer, founded the first El Teniente company, Braden Copper Company, and built a road for carts and a concentration plant.

In 1916, Braden Copper became a subsidiary of the Kennecott Corporation, which was able to supply the funds necessary to expand the mine. Kennecott operated El Teniente until 1971. In April, 1967 the Chilean Government acquired a 51% interest in the property, and founded the Sociedad Minera El Teniente. Following this agreement, major mine expansion was undertaken, and a new concentration plant was built in Colón, which increased total production capacity to 63,000 t/day. Full nationalization followed in 1971, and El Teniente mine became a fully state-owned company. In 1976 Codelco was formed, and El Teniente became part of it.

## Reserves

In total, the El Teniente orebody measures 2.8 km-long, 1.9 km-wide, and 1.8 km-deep. Schematically, the deposit is

formed around a central, barren, breccia pipe of 1.0 to 1.2 km diameter, surrounded by a mineralized rock mass. The bulk of the mineralization within the orebody is typical of massive, homogeneous copper porphyries. In fact, El Teniente is one of the largest porphyry deposits of copper in the world. The main rock types of the deposit are: andesite 73%, diorite 12%, dacite 9% and breccia 6%. At some time during its history, the deposit was affected by supergene alteration through percolation of meteorological water close to surface, which gave rise to secondary mineralization. This secondary ore is high in copper grade, but weak, and of good fragmentation and caveability. In contrast, the deeper primary mineralization is relatively low in copper grade, harder, and of moderate fragmentation and caveability. As can be appreciated, secondary ore and primary ore require very different approaches in terms of mining.

## Mining method

El Teniente produces some 334,000 t fine copper and 4,720 t molybdenum each year. Mass caving methods are employed to deliver approximately 98,000 t/day of ore to the mill from several sectors

underground, each sector being, in effect, a large mine in its own right. This case story focuses on the Esmeralda Sector, which is set to become the most important section of the mine, producing 45,000 t of the 130,000 t/day planned for El Teniente.

Since El Teniente began operations in the early 1900s, several exploitation methods have been used, though the secondary mineralization was ideally suited to conventional block caving.

However, the last mining sector located in secondary ore, Quebrada Teniente, was exhausted in 2003, and all current mining is in primary ore for processing at the expanded Colón concentrator.

El Teniente started large-scale mining of the primary ore in 1982, using LHDs and the fully mechanized panel caving method. The essential difference between panel caving and conventional block caving is that the former is a dynamic method in which the undercut is being continuously developed, and drawpoints incorporated at the extraction front, rather than being fully developed before caving is started. This method has been broadly successful at El Teniente, and close to 250 million t of ore have been extracted using panel

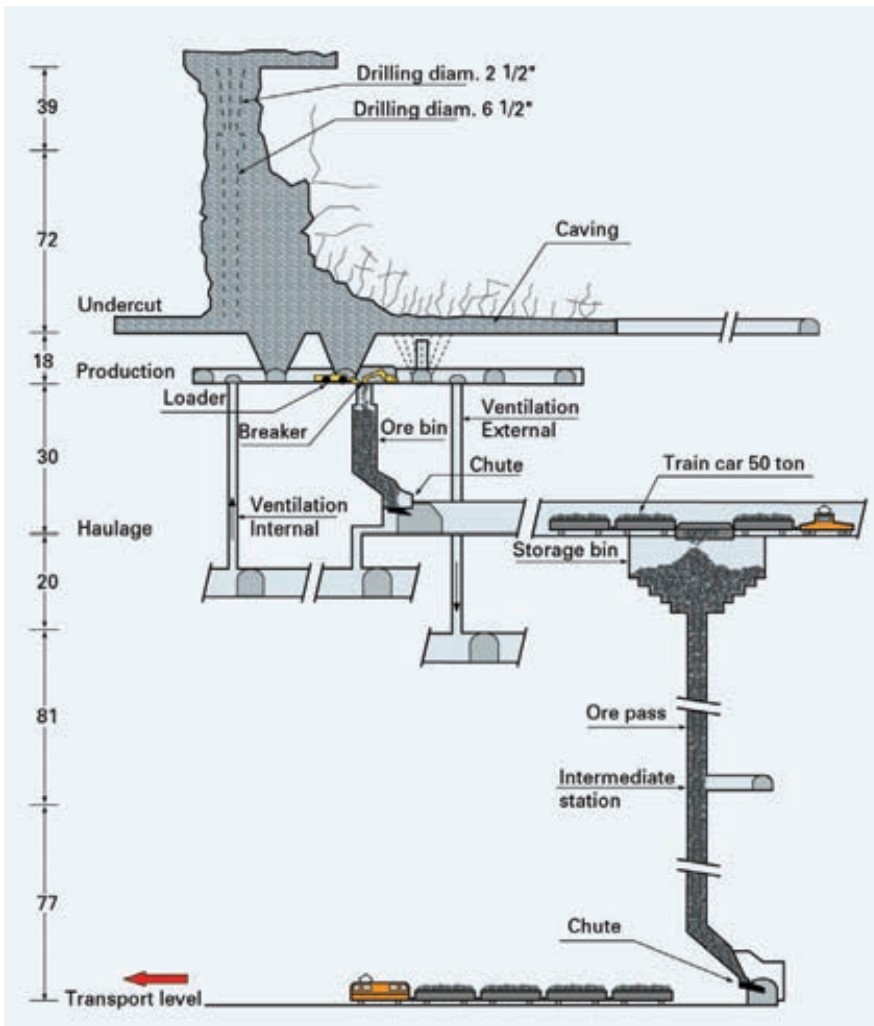

Panel caving with pre-undercut at Esmeralda.

caving in primary rock. Currently, two forms of panel caving are in use: standard panel caving as applied in the Teniente 4 Sur Sector; and panel caving with pre-undercut as used in the Esmeralda Sector.

## Exploitation sequence

The panel caving exploitation sequence initially used involved development and construction of production levels, undercutting at the undercut level, and ore extraction. However, the dynamic caving fronts, under high stress conditions of 40-60 Mpa, resulted in substantial damage to the infrastructure. Indeed, extraction in El Teniente Sub 6 Sector had to be stopped in March, 1992 after several rockbursts caused fatal accidents, reflecting the low level of knowledge at the time about mining in primary rock. Between June, 1994 and

August, 1997, El Teniente carried out experimental mining in a pilot area of 12,000 sq m. This process was closely monitored, and the data served as the basis for a full geomechanical study. From September, 1997 to June, 1998, during the pre-operational phase, it was realized that it was necessary to research the relationship between seismic potential, undercutting speed and the mining of new areas. Because of this, and for the first time since the 1992 production freeze, El Teniente carried out preparatory work in a 6,000 sq m area using simultaneous production techniques. The test succeeded, with no significant rockbursts, thus proving the relationship between seismicity and caving speed. Indeed, it is now recognized that the uncontrolled seismicity induced by the mining extraction rate of advance of the caving face and extraction speed has been the main

cause of damage to the tunnels and infrastructure on the lower levels.

Nowadays, there are variables incorporated into the mining design and planning concept to control the excess of seismic activity, not only improving the working conditions on the production level, but also increasing productivity. During the pre-operational phase, over 2 million t were removed from Teniente Sub 6, with only two small rockbursts.

## Esmeralda pre-undercut

Following on from the studies and controlled tests, El Teniente introduced a variation of its conventional panel caving undercut sequence. Known as pre-undercut, it essentially consists of developing the production level behind the undercut, rather than the more typical method where the production development is carried in parallel with the undercut ahead of the caving face. The pre-undercut achieves a better redistribution of the stresses ahead of the production development, resulting in less damage and improved safety.

Although the pre-undercut variant had been tested in some small sectors of the mine, it was first used on an industrial scale in the new Esmeralda sector. Occupying a total area of 714,000 sq m, Esmeralda is located at 2,210 m asl within the El Teniente deposit, bounded on the west by the Braden breccia pipe, and in the north by El Teniente Sub 6 Sector, and is below the Teniente 4 Sur Sector. Lithologically, it occurs mainly in andesite, and contains a total mineral reserve of 365 million t, with an average grade of 1.01% of copper and 0.024% of molybdenum. The total investment for Esmeralda was US\$205.6 million, with conceptual engineering and design initiated in 1992, and caving starting in August, 1996. Ore production started in September, 1997, and has built up from an average of 4,000 t/day in 1998 to 19,500 t/day in 2001, and full production of 45,000 t/day from 2005.

Caving at Esmeralda was achieved with 16,800 sq m of available production undercut, once a problem of 'support points' was solved. These formed above the apex of the crown pillar, and reduced the interaction between draw-points, making the flow of ore from



the undercut level difficult. The effective extraction rate defined for the Esmeralda sector was 0.14 to 0.44 t/day/sq m at the initial caving stage, and reached 0.28 to 0.65 t/day/sq m at the steady-state caving stage. The height of primary ore column to be exploited is around 150 m, relatively low if compared with Teniente 4 Sur, where the height is over 240 m.

At Esmeralda, 7 cu yd LHDs working on the production level load and tip into 3.5 m-diameter ore passes. Here, teleremote controlled hydraulic breakers positioned above 1 m x 1 m grizzlies break any oversize rock before it goes through the ore pass and into the loading bin. On the haulage level, the mineral is loaded into trains featuring Automatic Train Protection (ATP) and consisting of a locomotive with eight 50 t cars. These trains, which were retrofitted with an Automatic Train Operation (ATO) system, tip into storage bins which feed a 5.0 m-diameter ore pass to the main transport level Teniente 8. Trains with 90 t electric locomotives and 18 cars each of 80 t capacity carry the mineral out to the Colón concentrator. The main haulage level at Teniente 8 was recently upgraded, incorporating new technology similar to Esmeralda.

## Basic concepts

In the conventional panel caving and the pre-undercut variant, the same basic concepts apply. The main difference is the sequence of each of the operational elements. In the conventional panel caving method, the sequence of activities is: development of tunnels on each level for production and undercut; drawbell opening; undercut blasting; and extraction. In the pre-undercut variant, the undercut is excavated first, and the production level is developed subsequently within the stress-relieved zone: development of the undercut level; undercut blasting; development of the production level; drawbell opening; and extraction.

The main challenge associated with this variant involved the undercutting. Several alternatives were tried, with the current preference being a flat, low height 3.6 m undercut. The undercut is blasted some 80 m ahead of the actual production zone, with the production

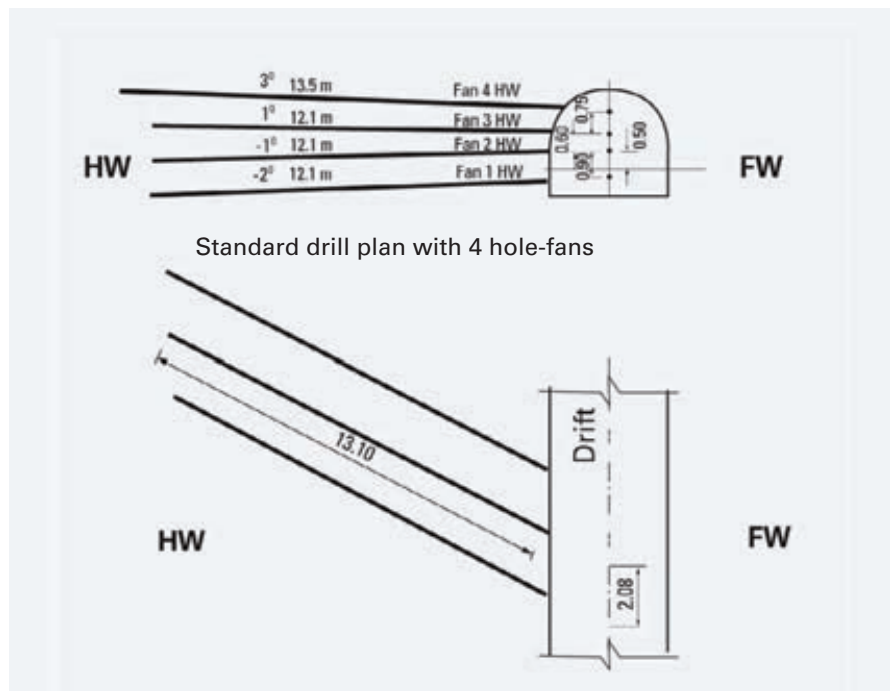

Plan of pre-undercut holes.

level and drawbell development following around 22.5 m behind the undercut, and 57.5 m ahead of the production zone.

The undercut comprises drives, 3.6 m-wide by 3.6 m-high, developed parallel to each other on 15 m centres. The excavation of the undercut is achieved by blasting three- or four-hole fans, some 7 m to 10 m length, drilled into the sidewall. The drill holes are fanned slightly, to ensure an undercut height equal to the height of the drives. Swell material from each undercut blast is removed by LHD to provide a free face for the next blast. The production haulage level is

developed 18 m below the undercut, giving a crown pillar thickness of 14.4 m through which the drawbells are then developed straight into the pre-blasted undercut. The production level requires substantial support, with fully grouted 2.3 m rebar installed in a 0.9 m x 1.0 m pattern immediately behind the face, followed by chain mesh and shotcrete. Permanent support is added around 15 m behind the face, and consists of fully grouted long cable bolts, with additional reinforcement at drawpoints. One of the challenges of this method is that two mining fronts have to be managed, one on the undercut level, and the other

Drilling patterns in andesite and breccia.

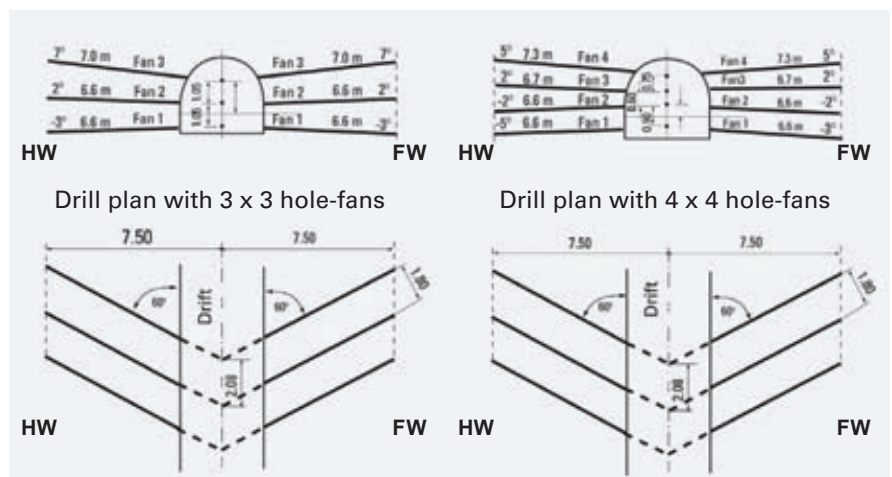

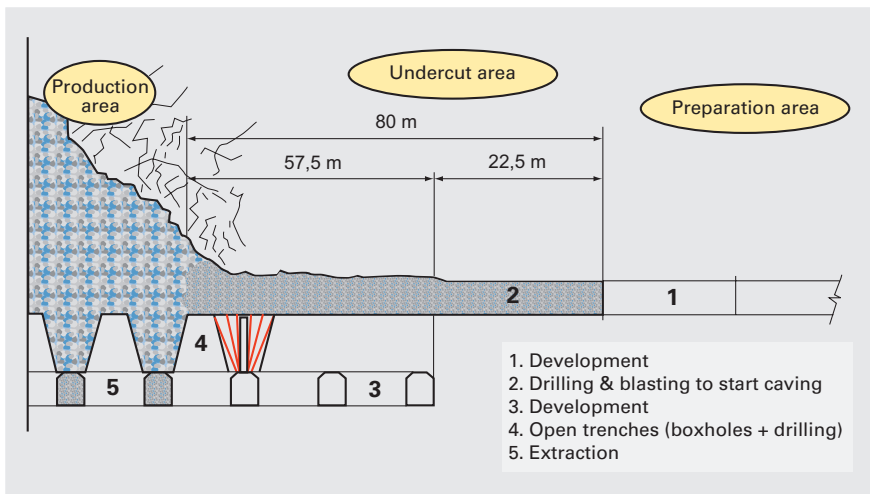

Principle of pre-undercut at Esmeralda.

located on the production level, and these in turn are related to the scheduling of the development of the drawbells, and construction of the drawpoints.

The pre-undercut variant has been a substantial success in the Esmeralda sector, with only minimal damage occurring on the production level, and its associated orepasses and drawpoints. There was a significant reduction of damage to the drifts located under the undercut level, as well as a significant reduction of rockburst occurrence by better draw management. The stability and rock condition with the pre-undercut variant dramatically improves, so it was possible to reduce the cost of support, and increase the availability of the area by nearly 90%.

Some optimization of the pre-undercut is still continuing, in particular some fine-tuning of undercut level pillars and improvement of the co-ordination and scheduling of the development activities. It is vital that the spacing of the activities is maintained, so as to keep the production development ahead of the active cave, but still within the destressed area.

Current productivity obtained at Esmeralda is over 115 t/day/worker. In comparison with other methods such as sublevel caving, panel caving gives El Teniente more advantages. The direct cost of the sublevel caving method is at least double that of panel caving, and the current direct cost for mine at El Teniente is US\$2.5/t of ore, and indirect costs close to US\$1/t

The average cost of panel caving is US\$3.5/t, compared to more than US\$5/t for sublevel caving. Hence, El Teniente is developing its new productive sectors using the panel caving method with pre-undercut, though other variants could be used, depending on the local conditions, lithology, stresses and economics of each sector.

## Production at Esmeralda

Cave undercutting at Esmeralda is presently carried out with the 'parallel long hole' technique, which basically consists of excavating an 855 cu m pillar of solid rock 11.4 m-wide, 25 m-long and 3 m-high. A triangular pattern of 14 parallel long holes of 3 in-diameter, with 9 rows of 2 holes and 1 hole each is used. This pattern has better efficiency, absorbs blast hole deviation, and avoids formation of residual pillars.

Drilling is carried out with an Atlas Copco Simba H157 drill rig, whose output is 60 m/shift of 3 in-diameter holes and 85 m/shift of 2.5 in-diameter holes. Standard ANFO is the column charge, with 300 gm cylindrical pentolite as the booster, detonated using Nonel.

Atlas Copco equipment at Esmeralda includes one Rocket Boomer, two Boltec rigs, two Simba rigs and one 3.5 cu yd Scooptram loader.

In the production level, a fleet of nine LHDs is used, including Atlas Copco Scooptram ST6C and ST1000 loaders of capacities 6 cu yd and 7.3 cu yd respectively.

The support methods used in Esmeralda include 22 mm-diameter and 2.3 m-long bolts, 6 mm-diameter by 10 cm spacing mesh, 10 cm-thick shotcrete, and 6 in-diameter cable bolts. There are two types of cable bolts, plain and birdcage, which are 4 m to 10 m-long, and 5 m to 7 m-long respectively.

## Raiseboring

In an interesting application during the development of Esmeralda, two Atlas Copco Robbins raiseboring machines, a 34RH and a 53RH were used. These are multipurpose machines, and can be employed for upwards boxhole boring or down reaming, as well as conventional raiseboring.

At Esmeralda, the Robbins 34RH unit was used in the production level to drill draw bell slot vertical holes approximately 15 m to 20 m-long and 0.7 m-diameter. The machine worked three shifts/day, giving a penetration rate of 2.1 m/h. It had a capacity of 93 m/month and a utilization rate of 39%.

The Robbins 53RH was employed to bore 1.5 m-diameter boxholes up to 75 m-long for use as ventilation shafts, and inclined pilot raises for orepasses, with an average length of 24 m. The machine worked three shifts/day, giving a penetration rate of 1.8 m/hr. It had a capacity of 111 m/month and a utilization rate of 57.3%.

Atlas Copco trained the operators from El Teniente, and was in charge of the equipment maintenance during the first few months.

## Rocket Boomer drill rigs

Shortly after acquiring the raiseboring machines, El Teniente acquired two Atlas Copco Rocket Boomer 282 drill rigs for drift development at Esmeralda.

In order to increase the drilling precision, the mine installed the Atlas Copco Feed Angle Measurement (FAM) instrument on the Rocket Boomer units. The machines also featured the direct controlled drilling system, which incorporates the anti-jamming function Rotation Pressure Controlled Feed Force (RPCF).

The Rocket Boomer rigs were fitted with COP 1838 rock drills with 20 KW



impact power and dual-damping system, giving high speed drilling and good steel economy.

According to Atlas Copco Chilena, which delivered the equipment, the Rocket Boomer units exceeded the management's expectations, and showed better results in comparison with the other rigs owned by the mine. For instance, in the development of 4 m x 4 m drifts, where each round required a total of 48 drill holes of 45 mm and two cut holes of 4 in-diameter, the Rocket Boomer rigs drilled holes 4.0 m-long, whereas the other rigs drilled holes 3.1 m-long. The Rocket Boomer rigs also surpassed the older drill rigs in penetration rate (1.9 - 2.0 m/min vs 1.23 - 1.28 m/min), drill m/effective hour (150 vs 77.5), drill m per round (200 vs 155), drilling time per round/min (85 vs 155) and advance rounds/shifts (3 vs 1.0 - 1.5).

## Maintenance programme

Today, in terms of maintenance, El Teniente is close to being self-sufficient, and does most of its own work. Maintenance programmes for all the units are based on the suppliers' information, plus experience gained in use. All this data is held on a centralized system that monitors all machines, checks when they need maintenance, and organizes what spares will be required. There are centralized maintenance workshops for drill rigs, LHDs and utility vehicles, with one major workshop for each machine type. In this way, the maintenance department and its team provide a central technical and maintenance service to all the sectors within El Teniente. Smaller workshops dispersed throughout the complex are used for repair or maintenance jobs of less than four hours duration.

Major rebuilds and repairs are handled at the central workshops on surface, one for component rebuilds, and the other for major machine overhauls.

Atlas Copco maintains a team of technicians permanently at the mine, working with the maintenance department on the commissioning of new equipment, and providing support and operator training during the warranty period of the units.

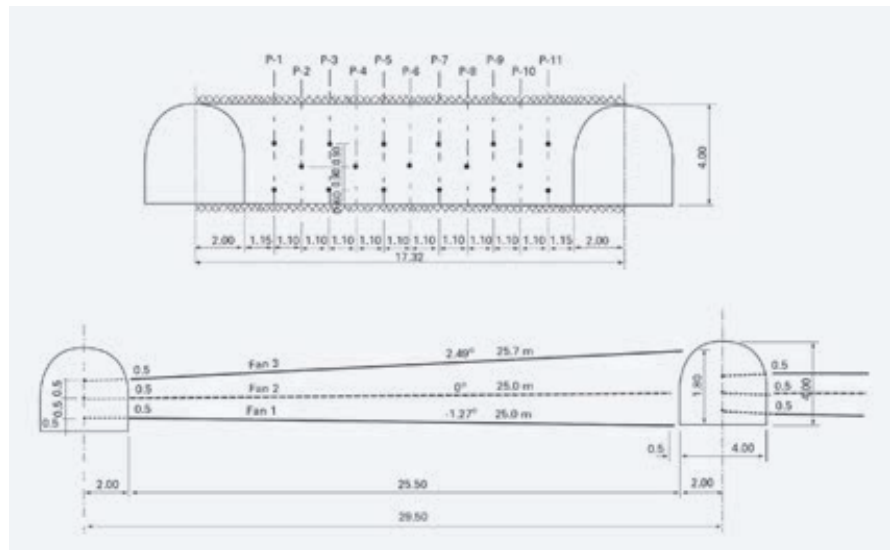

Undercut drilling to start the caving process.

## Recent developments

Framed within Codelco's current US\$4.2 billion strategic plan, the US\$1.1 billion Plan de Desarrollo Teniente (PDT) is the great mining, technical and management strategic plan of El Teniente Division for the next 25 years. Its objective is to expand the production capacity at all levels, including mine, concentrator, smelter, hydrometallurgy and services, and increase El Teniente's economic value by over 90% from US\$2 billion to US\$3.8 billion.

Amongst other things, the plan contemplates the incorporation of world-class technology.

Occupying an area of 190,000 sq m, Reservas Norte/Sector Andesita is located north of the Teniente Sub-6 sector. Its reserves are estimated to be 125 million t, with an average grade of 1.14% copper. Its useful life will last until 2019, and during operation it will require a workforce of 280 people. Construction was started in 2000 for production commencement in 2003. Production is planned to reach 35,000 t/day and, like Esmeralda, Reservas Norte is being exploited by panel caving with the pre-undercut variant. Main equipment includes 14 LHDs of 7 cu yd capacity, 16 plate feeders, eight 80t trucks, four hydraulic breakers, and five 1,400 HP fans. On the production level, the LHDs tip into 34 m-long orepasses. On the haulage level, the 80t trucks, loaded by plate feeders, empty the min-

eral into four storage bins fitted with large hydraulic breakers and grizzlies. One of the objectives of this project was to automate and remotely control the operations of truck haulage, plate feeder loading, and rock reduction by breakers.

With an area of 57,600 sq m, Pipa Norte is located north of the Braden pipe and south of the Quebrada Teniente sector. Its reserves are estimated to be 27.1 million t, with an average copper grade of 1.024%. Construction started in 2001 for production commencement in 2003, with a peak rate of 10,000 t/day by 2005 and a useful life of 10 years. The exploitation method is panel caving with pre-undercut and low excavation, with a labour force of 43 people and a planned personal average productivity rate of 220 t/day. 13 cu yd capacity diesel LHDs are part of a semi-automated loading operation, with an operator on surface remotely controlling three loaders. LHD transport and unloading is fully automated.

Located south of the Braden pipe, Diablo Regimiento takes up an area of 201,200 sq m. Its reserves include 98.9 million t, with an average grade of 0.94% of copper. Construction started in 2001 for commencement of production in 2004, aiming at 28,000 t/day by 2011 with a planned life of 16 years.

Average productivity is estimated to be 230 t/day, with a peak labour force of 115 people. The exploitation method used is again panel caving with



preundercut. With a main equipment fleet of 13 cu yd LHDs, Diablo Regimiento is planned as a semi-automated operation, similar to Pipa Norte.

Occupying an area of 160,000 sq m, Pilar Sub 6/Esmeralda is bounded in the south by the Esmeralda sector, and in the north by the Andesita and Dacita areas, which are located west of Quebrada Teniente. Its reserves are estimated to be 76.6 million t, with an average grade of 1.27% copper.

Construction started in 2003 for first production in 2005, and a peak rate of 18,000 t/day between 2009 and 2016. Productivity has been estimated as being 150 t/day per worker, with a labour force during operation of 120 people. The exploitation method is panel caving with pre-undercut, and main equipment includes LHDs, 80 t trucks, plate feeders, breakers, crushers, and drill rigs for secondary reduction.

## New mine level

From 2014 onwards, El Teniente will incorporate the New Mine Level (NML) project into its production plan. This will become the most important underground panel caving project, and will sustain the production plans in the long term, exploiting only primary ore from an undercut level located at 1,880 m asl. The new level will be divided into five mining sectors, with 1,371 million t of total ore reserves of 0.96% copper grade covering an area of 1.6 sq km. Initial production rate will be 2,000 t/day, reaching 130,000 t/day ultimately.

The NML will deepen the exploitation of the deposit 100 m below the current main transport level, and will incorporate blocks with an average of 300 m height. New infrastructure includes the transport level, service shafts, primary crusher chambers, and drainage and ventilation levels.

## References

*This article is based in interviews with management from El Teniente and the following papers:*

**P Yanez and R Molina,** *New Mine Level Project at El Teniente.* Massmin 2004.



*Atlas Copco Robbins 53RH raise borer.*

**F Varas,** *Automation of Mineral Extraction and Handling at El Teniente.* Massmin 2004.

**M Larrain,** *Overview El Teniente Division, Presentation to MBA Students Vanderbilt University USA,* 2002.

**M Barranza and P Crorkan:** *Esmeralda Mine Exploitation Project.* Massmin, 2000.

**E Rojas, R Molina, A Bonani and H Conzanzo:** *The Pre-Undercut Caving Method at the El Teniente Mine,* Codelco, Chile. Massmin, 2000.

**M Larrain, P Maureira,** *Plan de Desarrollo 2000, Division El Teniente, UGA MINCO, Executive Summary,* 2000.





# Boxhole boring at El Teniente

## The lieutenant marches on

State owned Codelco is Chile's largest company and the world's largest producer of refined copper. The Codelco-owned El Teniente (The Lieutenant) mine is presently the world's largest underground mining operation. The mine average production rate is currently 126,000 t/day. Boxhole boring between the production and haulage levels using Atlas Copco Robbins machines is a major component in achieving such high outputs.

Recently, two raise borers modified to suit the El Teniente mine conditions were commissioned by Atlas Copco. They were evaluated for three months, during which time the crews were trained in their operation. Both exceeded the set target performance criteria.

## Introduction

Codelco, renowned for its refined copper output, is also the second ranked world supplier of molybdenum, as well as being a major producer of silver and sulphuric acid, both of which are by-products of its core copper production.

The El Teniente mine, located high in the Andes at an elevation of 2,100 m, has been producing copper since 1904.

The orebody is 2.8 km-long by 1.9 km-wide, and is 1.8 km-deep, with proven reserves of some 4,000 million t, sufficient for a mine life of 100 years. Approximately 2,800 miners work seven levels on a 24 h/day, 7 day/ week operation.

El Teniente production increased significantly in 2005, when its new Esmeralda section came on line, using the pre-undercut panel caving method. Overall mine output has increased by 31,000 t/day, with 45,000 t/day coming from the Esmeralda Project, making it the most important sector in the mine. The two new boxhole boring systems supplied by Atlas Copco Robbins are a vital part of this production system.

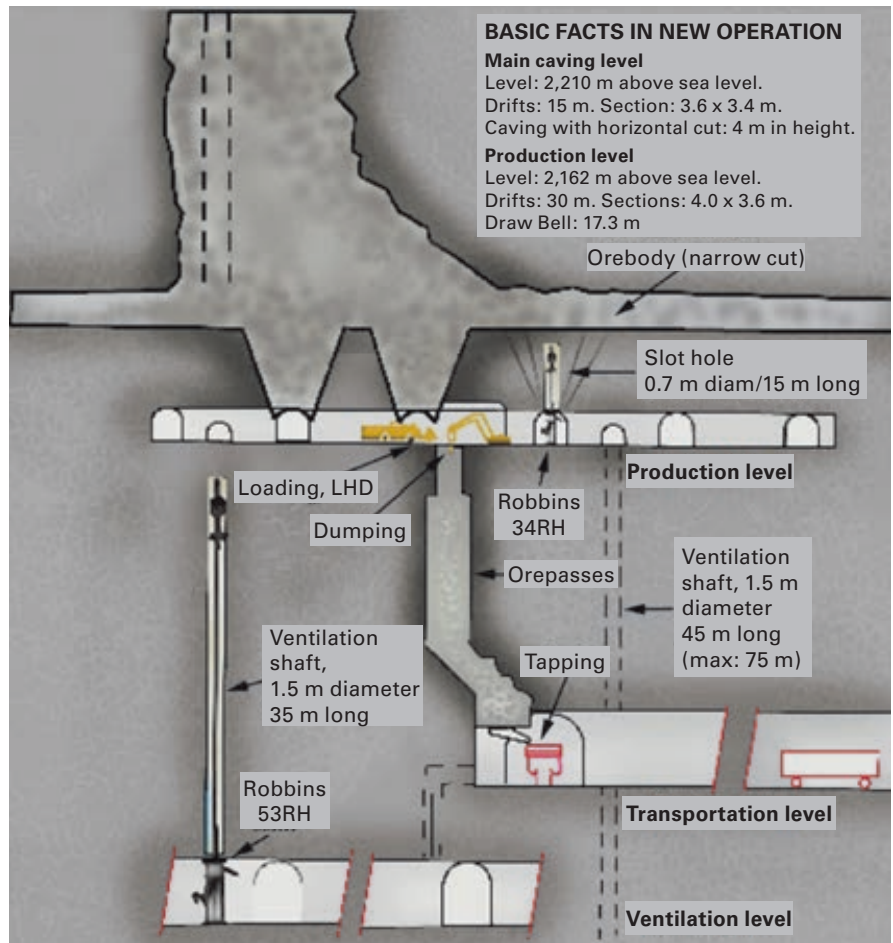

Mining method at El Teniente.

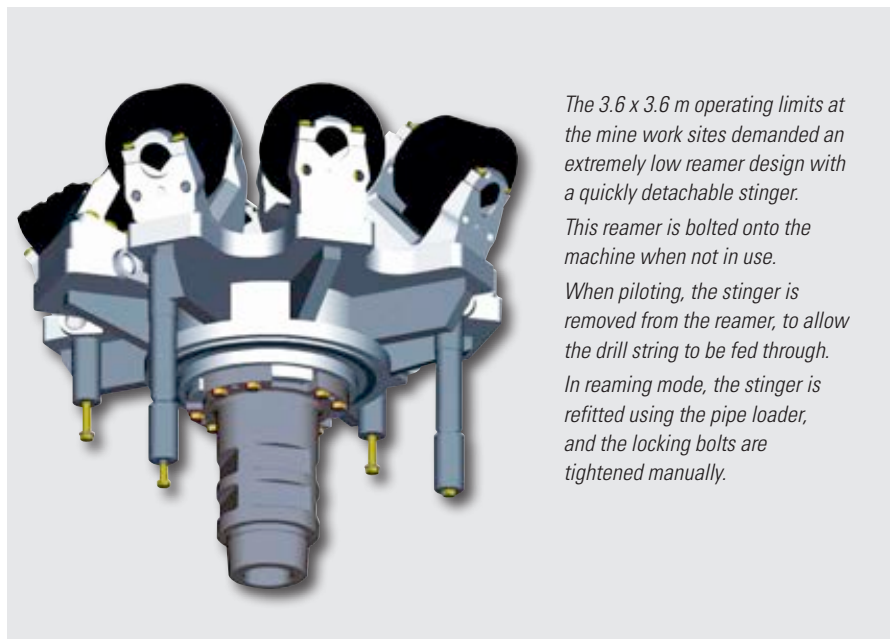

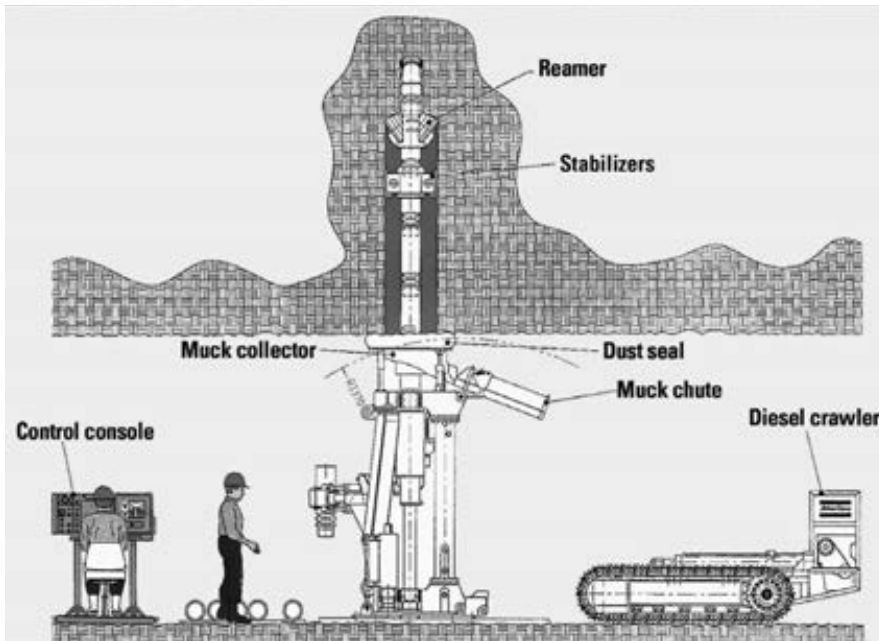

Boxhole equipment.

## Mine requirements

El Teniente tendered for the purchase of two boxhole boring units to excavate the draw bell slot holes for the panel caving operation. These units would also be used to bore ventilation raises and ore passes between the production and the haulage level. The vertical draw bell slots are generally 15 m-long and 692 mm-diameter. A total of 800 m, comprising 45-50 shafts, are bored annually.

Because drifts have not been developed on the production level, all ventilation raises and ore passes are bored from the haulage level and upwards using the boxhole boring technique. The average length of the vertical and inclined ventilation raises is 25-50 m. The inclined ore passes average 25 m-long, but this varies up to 75 m-long. The total annual requirement for 1.5 m-diameter bored raises is 1,000 m.

Restrictions are placed on the machine design by the size of the underground sections. Work sites measure 3.6 x 3.6 m, and maximum transportation dimensions are 2.5 m-wide x 2.5 m-high x 4.8 m-long. The machines must either be self-propelled or transported on rail, and have to have tramming and directional lights, as well as a fire extinguisher system. The mine electrical installations provide power at 575-4,000

V, 3-phases at 50 Hz, and 24-220 V, single phase at 50 Hz. Each machine is designed for three, or less, operators per shift.

The operating environment is 2,300 m above sea level, with temperatures from +25 degrees C to 0 degrees C. Relative humidity varies from 15% to 90% in the mine, where acid water and occasional blast vibrations may be experienced. Both machines are operated 24 h/day, 7 days/week, with a maximum machine utilization of 15-16 h/day.

## Evaluation period

An evaluation period of three months was established to study the performance capabilities of each machine. Target performance criteria for the smaller slot hole machine was set at 264 m bored during the three month period, and 330 m for the larger boxhole machine.

This performance target was based on a 24 h/day operation, with net available operating time of 15-16 h. The number of operating personnel required, set-up and moving time, the rate of penetration and machine availability were all recorded during evaluation period.

Atlas Copco boxhole boring units Robbins 34RH and 53RH were found to meet the requirements of the up-hole boring tender, and were selected by the mine. Built on the experience of the

52R, the 53RH multi-purpose machine has been developed since the early 1980s. The 34RH has been used as a raiseboring and downreaming machine for a similar period, and was first introduced in the boxhole configuration in 1998. To accommodate the restricted working space in the mine, the already low-profile 34RH and 53RH had to be redesigned to further decrease the working height. Both machines are self-propelled, and equipped with efficient muck collectors, remote-controlled pipe handling and automatic data logging.

## Atlas Copco Robbins 34RH

The Robbins 34RH is a low profile, small diameter raise drill, designed for applications such as slot raises, backfills and narrow-vein mining. This multi-purpose, lightweight raise drill can be used for downreaming and upward boxhole boring, as well as for conventional raiseboring.

The machine features a variable speed hydraulic drive with a two stage planetary gearbox, and hollow-centre shaft to enable pilot-hole flushing. To change boring methods, the Robbins 34RH is easily turned upside down, to orient the drive head into either upward or downward boring position.

The Robbins 34RH was already a true low-profile raise drill. However, to accommodate the restricted site dimensions, and to allow room for a muck-handling system on top of the machine, the maximum working height had to be lowered further. This was achieved through the use of shorter high-thrust telescopic cylinders, and by utilizing 750 mm-long by 254 mm-diameter drill rods.

This reduced the working height of the assembly to 3.6 m, including the muck handling system.

The new muck handling arrangement, which had been fitted on two earlier Robbins 34RH machines commissioned in 1998 and 1999, has been further developed for efficient muck collection in the boxhole boring mode. The remote controlled and hydraulically operated muck collector is fully integrated into the derrick assembly, and remains on the machine, even during transportation.



During pilot hole drilling and reaming, the rubber sealed muck collector is applied adjacent to the rock face. The muck slides on a chute assembly to the rear of the machine.

The two earlier Robbins 34RH machines featured a 270 degree working range, with muck spilling to either side or to the rear end of the machine, whereas the muck chute on the new El Teniente 34RH machine has a working range of 90 degrees, due to simpler and more compact design.

The Robbins 34RH features a remote controlled hydraulically operated slide-opening worktable for use in both down-reaming and boxhole boring applications. The entire drill string, including boxhole stabilizers and reamer, can pass through the worktable of the machine.

The standard frame Robbins 34RH currently in use at El Teniente accommodates a 692 mm-diameter reamer through the worktable, while a wide frame model of the 34RH accommodates a 1,060 mm-diameter reamer.

The Robbins 34RH worktable is equipped with semi-mechanized wrenching, which features a hydraulically powered forkshaped wrench manipulated from the operator's control console.

The rod handler is designed to pick up all drill string components, including boxhole stabilizers and reamer.

## Robbins 53RH

The Robbins 53RH is a low profile, medium-diameter raise drill, suitable for boring orepasses and ventilation shafts. It is a versatile multi-purpose machine, capable of boring upwards boxhole, downreaming, or conventional raiseboring, without modification to the drive assembly.

It has a hydraulic drive to enable variable rotation speeds and has dual drive motors placed offline on a gathering gearbox that transmits torque to the drive heads.

The Robbins 53RH features a raise-boring and a boxhole float box, which allows the boring methods to be changed by simply installing drill rods in either the upper or lower float box. In addition, this multi-purpose unit is provided with a removable water swivel, to



*Robbins 53RH set up underground.*

facilitate pilot bit flushing in both raise-boring and boxhole boring modes.

The El Teniente machine has been substantially upgraded from previous versions of the Robbins 53RH, to increase its productivity and working range. The input power has been increased by 31% to 225 kW, the torque has been increased by 44% to 156 kNm, and the thrust by 21% to 3,350 kN.

To achieve the same low profile as standard Robbins 53RH machines, high thrust telescopic cylinders have been used. This has resulted in a machine with an overall height of just 2.9 m that utilizes 750 mm-long drill rods with an outer diameter of 286 mm.

For ease of operation, the unit is equipped with semi-mechanized wrenching in the worktable, as well as the headframe. This features a hydraulically powered forkshaped wrench manipulated from the operator's control console.

The larger Robbins 53RH does not feature an opening worktable, as the wings of the stabilizers and the reamer are attached on top of the machine.

Muck is handled by a separate collector system designed to suit the machine. Unlike the Robbins 34RH, this muck collector is not integrated into the machine design, but is attached to the rock face by means of rock bolts. As it is separated from the derrick

assembly, this remote controlled, hydraulically operated system provides a 360 degree working range for channelling the muck away from the machine.

The remote controlled rod handling system on the Robbins 53RH is used for side and ground loading of drill pipes. This configuration of pipeloader has previously been used on all other Robbins models, and is now available on the 53RH. Due to the restricted machine dimensions, it is not possible to add the stabilizers within the machine frame. Instead, the pipeloader inserts a stabilizer pipe with stabilizer wing attachment sleeves.

Once this is pushed through the headframe, the lightweight stabilizer wings are attached to the sleeves before continuing on through the muck collector, and into the hole.

A new reamer handling system has been integrated into this machine design to eliminate the handling of the reamer at each set up. The reamer has been designed to bolt on top of the headframe during transport and erection. The hollow centre design of the reamer still allows prepiloting of the hole if desired, in which case a special stinger is inserted through the headframe and into the reamer, whereas the reamer is unbolted from the machine frame and attached to the stinger. The diesel transporter used for this machine is sized to

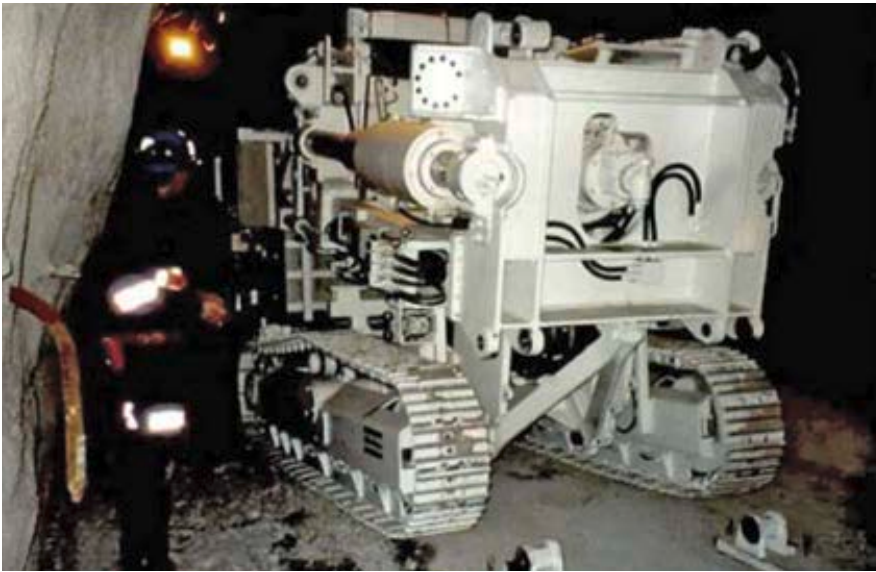

Diesel powered crawlers are used for transporting Robbins 34RH and Robbins 53RH.

accommodate the derrick, including the attached reamer.

## Additional equipment

The boxhole boring machines working in El Teniente were each delivered with a diesel powered crawler, for rapid movement of the derrick from site to site. The newly designed crawler features a cordless remote controlled operating system and a high-power Deutz diesel engine for high-altitude operation and minimal environmental impact.

To give the mine better control over machine productivity, a Data Acquisition System was delivered with each machine. This records operating variables in real time, and stores them on a memory card. It also features a display panel that shows the parameters being recorded. The machine operator can view any variable, as well as current time and date, and battery life during operation.

The recording brick is configured to log data to the memory card every 30 seconds. During the interval, variables are continuously monitored and key points are logged. The Data Acquisition System is provided with a data analysis software package which processes the output from the recording brick stored on the memory card, and creates graphical plots of the data. The software also generates data files that can be inserted into spreadsheets.

## Raise drill performance

As the use of boxhole boring units was new to El Teniente mine, the evaluation period was preceded by startup and commissioning of the machines. After approximately four weeks of training and commissioning, the machines went into full 3-shift production, and the three months evaluation began.

## Robbins 34RH evaluation

The startup period for this machine type included classroom and maintenance training, and the drilling of three raises. The average net penetration rate achieved was 0.8 m/h, or 3.9 m/day. The startup period was strongly affected by lack of water to flush the pilot bit, poor ventilation, and availability of concrete pads in the working area. However, learning progressed steadily, and the operating crew was ready to begin the evaluation period at the completion of one month's training.

During the three-month evaluation period, seven raises of approximately 14 m in length were drilled each month. The average production rate was 93.3 m/month, with a total production of 280.1 m for the entire period. This exceeded the monthly target rate of 88 m and 264 m for the full period. The average rate of penetration during the three months was: 1.80 m/h; 2.15 m/h; and 2.17 m/h. Machine utilization during

the evaluation period was 29.8%, with a mechanical availability of 95.5%.

Lack of access to the machine due to shift changes, blasting and non-worked weekends had the greatest negative affect on machine utilization. The second largest contributing factor was lack of site availability. During the completion of 20 production holes, the average move and set-up time was between 10 and 12 h. Drilling each hole took two days, which compensated for the low machine utilization, and provided a high rate of production.

Some downtime resulted from the replacement of instruments broken by rock falling from the face, and time was also taken to improve the protection of these parts. The boring cycle included pre-piloting of 1 to 2 m, depending on the ground conditions. After that, the hole was bored to full diameter in a single pass. The 692 mm reamer mounts two RCC raiseboring cutters, and an attachment for the bit sub and pilot bit. During single pass boring, the 279 mm pilot bit is also engaged in cutting the rock. To ensure adequate flushing of the cuttings past the bit-sub, water was pumped through the centre of the drill string to the tricone bit.

As the drilling took place on the production level of the block caving operation, the hole actually broke through into the broken ore. As there is no access to the head, it was critical to observe any changes to thrust and torque on the machine, to know when breakthrough occurred. The moment breakthrough was achieved, boring was stopped, as any further advance could result in the reamer getting stuck.

## Robbins 53RH evaluation

In addition to classes and maintenance training on the Robbins 53RH, a couple of holes were drilled as part of the commissioning. Again, the startup period was strongly affected by lack of water, poor ventilation, and availability of concrete pads in the working area. However, as the personnel were, by this time, well-trained raiseboring operators, the evaluation period could begin within a few weeks.

During the three month evaluation period, three raises of approximately



40 m in length were drilled each month. The average production rate was 111.1 m/month, and total production was 333.2 m for the entire period. This exceeded the monthly target rate of 110 m and 330 m for the full period. The average rate of penetration during the three months was: 1.12 m/h; 2.60 m/h; and 1.63 m/h. Machine utilization during the evaluation period was 40.3%, with a mechanical availability of 91.3%.

Machine utilization was again negatively affected by non-worked weekends, blasting near the drill site, and shift changes. The next largest factor contributing negatively to machine utilizations was site availability due to site cleaning, waiting for concrete pads, and the availability of electricity and water. During the completion of nine production holes, the average move and set up time for the machine was between 13 and 15 h. As drilling of a hole could be completed in a little more than 6 days, a high production rate was achieved, despite the low rig utilization.

The boring cycle included pre-piloting of 2 to 3 m, to ensure the straightest hole possible. This also facilitated easier reamer collaring, by reducing deviation caused by the dead weight of the reamer head.

Following completion of the pilot, the hole was bored to full diameter in a single pass. The 1.5 m reamer mounts eight RCC raiseboring cutters, and an attachment for the bit sub and 311 mm pilot bit. As with the smaller machine, water was pumped through the centre of the drill string to the tricone bit, to ensure adequate flushing of the cuttings past the bit-sub.

## Conclusion

The application environment in the El Teniente mine placed high demands on the boxhole boring equipment supplier, both in size constraints, and in operation of the equipment. The mine personnel also had aggressive performance expectations, in keeping with the established high productivity of the mine.

Atlas Copco chose to offer its proven 34RH and 53RH boxhole machines with customized features to meet the special needs of El Teniente. Most of these



*Robbins 34RH.*

features were focused on accommodating the restrictive work environment and high performance expectations.

After thoroughly monitoring the capabilities of both machines, the project in El Teniente has provided important



input to future development of boxhole boring technology. With production results exceeding expectations, it has also proved to be a new milestone in the application of boxhole boring machines.

### Acknowledgement

*Atlas Copco is grateful to the management and staff at El Teniente for their help and assistance with this article.*

Rock Type	Composition [%]	Density [ton/m <sup>3</sup> ]	UCS [MPa] [MPa]	Young's Modulus [---]	Poisson's Ratio
Andesite Fw	36	2.75	100	55	0.12
Andesite Hw	24	2.75	125	55	0.17
Anhydrite Breccha	20	2.70	115	55	0.17
Andesite Breccha	12	2.70	100	50	0.12
Diorite	8	2.75	140	60	0.15

*Rock properties at El Teniente.*

*Robbins 53RH-EX under test.*





# Modernization at Sierra Miranda

## Computerized systems

The Sierra Miranda copper mine in Chile has undergone a complete transformation over the last year, as a result of which it is now rated as one of the most modern mines in Latin America. Along the way, the mine has acquired a purpose-matched fleet of new generation Atlas Copco equipment, capable of high output without the availability of a high tension underground electricity supply. To support this process of modernization, proactive and preventive service and maintenance is essential, and the management at Sierra Miranda know that good aftermarket support for this type of advanced equipment is vital in order to achieve their production goals. It was for this reason that the mine entrusted Atlas Copco as a true partner, having confidence in their reputation as a serious company with a lot of experience.

## Large operation

The Sierra Miranda Mine, located about 60 km northeast of the city of Antofagasta, is one of Chile's largest underground mining operations and has a history of using the most modern mining techniques and equipment available.

Sierra Miranda lacks a substantial power facility, with the exception of electricity for lighting and ventilation, and has no water or air supply lines. As a result, to mechanize effectively, all of its underground equipment has to be self-sufficient. The drill rigs, for example, are all diesel-hydraulic with independent water-mist flushing systems.

The mine's total production is 3.3 million t/y, 1.1 million t of which is waste rock from development work, and the remaining 2.2 million t is copper ore with an average grade of 0.75%.

The host rock is volcanic andesite and the mineral deposit is principally copper malachite, a combination of

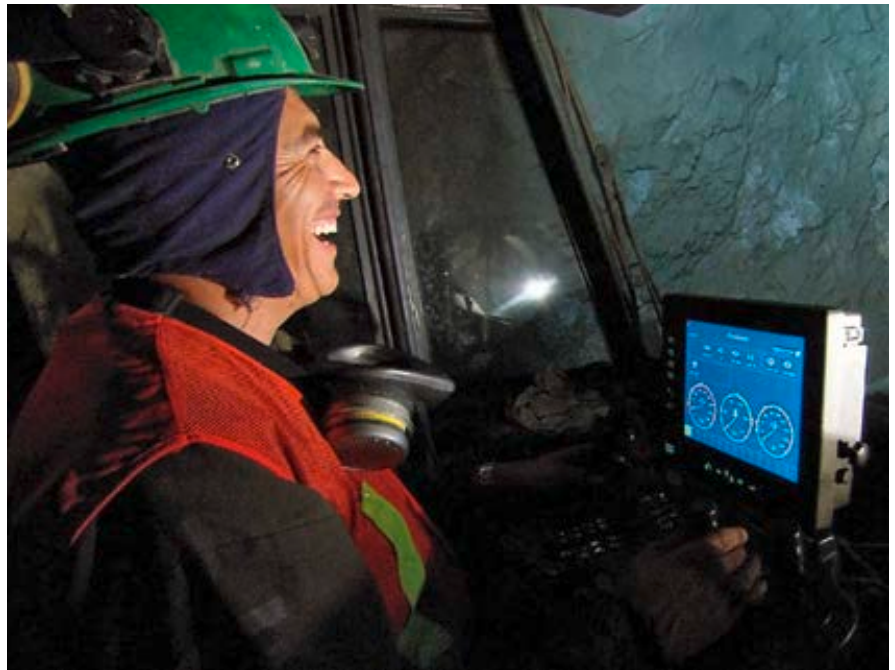

*At the controls of a Rocket Boomer L1 C drill rig. Operators at the Sierra Miranda mine appreciate the benefits of the computerized systems.*

copper pitch ore and chrysocolla, with sporadic atacamite.

Three years ago, the mine owner started the first stage of modernizing the mine's operations. This required the latest generation of equipment in order to improve the systems for extraction and the mining processes.

## Atlas Copco fleet

Sierra Miranda is one of the few, and possibly the only mine of its size in the world, that is equipped with diesel-hydraulic machines.

Currently, the mine production drilling fleet is all Atlas Copco, including a Simba M6 C, four Rocket Boomer L1 C drill rigs equipped with the RCS computerized rig control system, and a Scaletec scaling rig, which is the first of its kind in Latin America.

In addition, the mine has five Atlas Copco ROC 460 PC drill rigs, and Diamec U6 and CT14 exploration rigs, as well as various mobile compressors.

The production fleet of mobile equipment comprises four Scooptram

ST1020 remote controlled loaders. A Scooptram ST2G loader and an additional Simba are also expected to join the fleet this year.

The owner is investing in the latest generation of equipment in order to grow the mine as quickly as possible, and the selection of Atlas Copco machines has provided the exact match for this requirement.

## Efficient production

Sierra Miranda has a workforce of about 300, including contractors' personnel. The mining method is sublevel stoping, without backfill. As the orebody is relatively narrow at 4-10 m-wide it is necessary to use an extraction method that is both precise and focused.

The deposit is situated near the surface, which from a geo-mechanical point of view is favourable, as the support pillars in the mine are not subjected to excessive pressure.

Until recently, Atlas Copco ROC 460 truck-mounted drill rigs with short feeds and DTH hammers were used

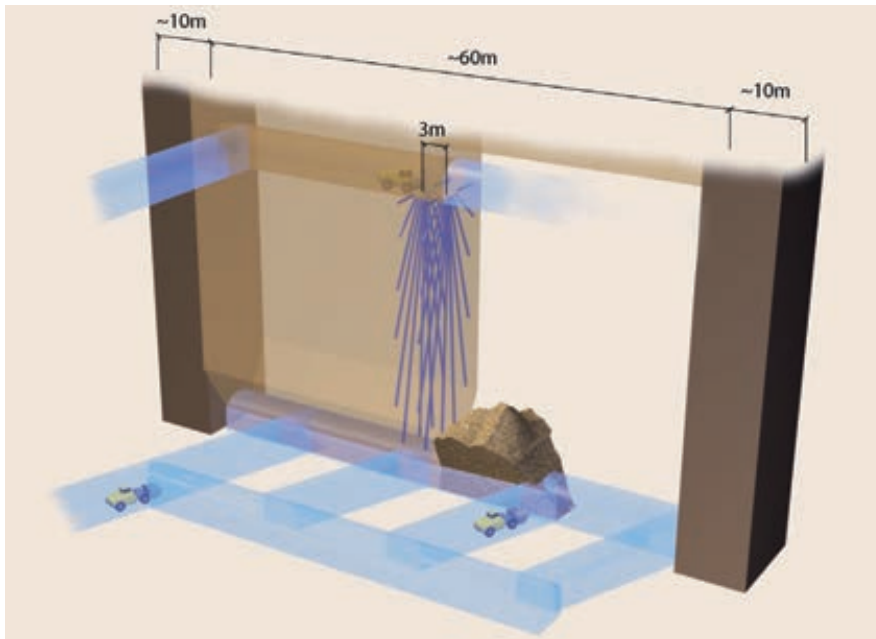

Schematic of sublevel stopping in a narrow vein using the Simba M6 C to drill down holes.

for drilling the blast holes, and also for developing 40 m-deep raises between the levels.

In order to minimize dilution in the narrowest veins, it was decided to employ a Simba M6 C drill rig equipped with a COP 2550 rock drill on production drilling of downholes in this narrow vein/sublevel stopping operation. At the same time, the distance between levels was reduced to 25 m and the hole diameter was reduced from 4 in to 3.5 in.

The Rocket Boomer L1 C rigs are used both for development and production. Each rig, equipped with a single COP 1838HF rock drill, advances at a rate

of 800 m/month in galleries that are 5 m-wide x 5 m-high. Scooptram ST1020 loaders are used for hauling and transport during the development of galleries and ramps.

The Scaletec is used throughout the mine for preparing faces for loading and for general roof scaling, mechanizing an operation that was previously time-consuming and sometimes dangerous.

The ore is transported to the surface by conventional 40 t-capacity trucks.

### Change for good

The technological changes at Sierra Miranda have been rapid. In less than

a year, the entire mine fleet has been upgraded to modern equipment. In addition, the operators have acquired new skills and the whole team is now focused on increasing the planned production levels and on improving risk and security standards.

Furthermore, productivity has increased beyond all expectations. While the improvements continue, the mine is also making every effort to achieve ISO 9000 certification.

At Sierra Miranda Atlas Copco works in a very proactive way. The fleet is checked daily for the number of hours each machine has worked, and the causes of any breakdowns. It is then decided which machines will be required for work over the following few days, and Atlas Copco makes sure that they are available. This entails a very flexible programme of maintenance and follow-up procedures, which can change from one day to the next.

At the start of the contract, the mine stipulated that it required 90% equipment availability. This took a little time to achieve while training was underway. However, once all systems were up and running, availability increased to its present level of more than 95%.

### Acknowledgements

*Atlas Copco is grateful to the owner and management at Sierra Miranda mine for their assistance with the preparation of this article which first appeared in Mining & Construction 1-2007.*

Scaletec in action at Sierra Miranda.



Close-up of the Scaletec at work.







# Mount Isa mines continues to expand

## Quadruple ores in Queensland

Mount Isa Mines, located in north-west Queensland, having an annual ore production in excess of 10 million t, constitutes one of the larger underground mines in the world. It is wholly owned by MIM Holdings, and is one of few places in the world where four minerals are found in substantial quantities, and mined in close proximity. The mine is one of the three largest producers of lead in the world, is the fifth largest producer of silver, the 10th largest producer of zinc, and is the 19th largest producer of copper. Another superlative is that the recently developed Enterprise copper mine is the deepest mine in Australia. Atlas Copco equipment is widely used at the Mount Isa Mines for production drilling, raiseboring and roof bolting.

## Geology

The mineral deposits zone at the central Mount Isa mining complex lie in an approximate North-South orientation, and dip towards the West.

Economic copper sulphide mineralization lies within a brecciated siliceous and dolomitic rock mass, known locally as 'silica-dolomite', which is broadly concordant with the surrounding Urquhart Shale. There are several copper orebodies. The silica-dolomite mass which hosts the 1100 and 1900 orebodies has a strike length in excess of 2.5 km, a maximum width of 530 m, and a height of more than 400 m. The recently developed 3000 and 3500 orebodies lie as deep as 1,800 m. Copper mineralization is truncated by a basement fault, bringing altered basic volcanic rocks (Greenstone) into contact with the Mount Isa Group sediments. The dominant sulphide minerals are chalcopyrite, pyrite and pyrrhotite forming



*Mount Isa at sunset.*

complex veins and irregular segregations within the breccia mass.

Mount Isa's stratiform silver-lead-zinc sulphide mineralization occurs with pyrite and pyrrhotite in distinct bands dipping to the west, concordant with weakly bedded carbonaceous dolomitic sediments of the Urquhart Shale. The mineralization is intermittent through a

stratigraphic interval of over 1 km, but the major orebodies are restricted to the upper 650 m. The orebodies occur in an echelon pattern, interlocking at the southern and lower sections with the extremities of the silica-dolomite mass hosting the copper orebodies.

The position, extent and metal content of copper and silver-lead-zinc

*Boltec 335S at Mount Isa.*



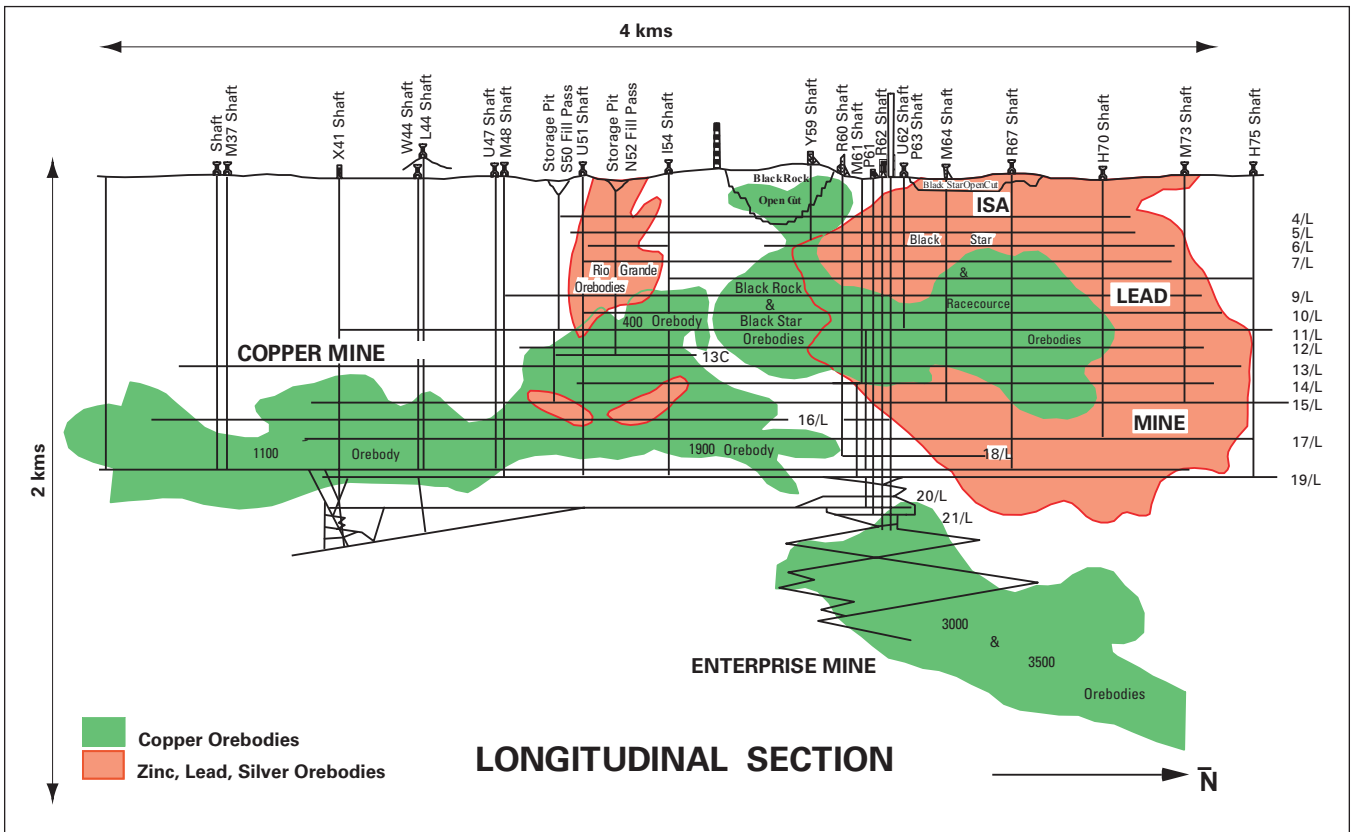

Longitudinal section of Mount Isa mine.

orebodies have been established by exploration drilling from the surface and underground. Despite the depth of the mines, stresses in the ground are not as great as at some shallower mines in other regions of Australia.

### History and development

John Campbell Miles discovered silver-lead ore at Mount Isa in 1923. Although mining began in 1924, Mount Isa Mines didn't make a profit until 1937, due to

problems of isolation, mine flooding and shortage of capital.

Lead-zinc-silver production was the original focus of Mount Isa Mines. Although short periods of copper production had occurred during World War II, parallel production of copper did not begin until 1953, after extensions to the mining operations. The development of copper orebodies in the late 1960s and early 1970s, as well as improvements to the Company's Townsville refinery, greatly increased copper production.

The Mount Isa group comprises several mines. The Hilton lead-zinc-silver mine, 20 km north of Mount Isa, opened in 1989, and is now incorporated into the George Fisher Mine. The next large development came in the late 1990s, when close to \$1bn was invested in projects, including the new George Fisher lead-zinc-silver and Enterprise copper mines, as well as expansion of the copper smelter and the Townsville refinery.

The Enterprise is an extension of the Mount Isa mine, in the deep 3000 and 3500 orebodies lying beneath existing mining zones.

Simba H4353 long hole drill rig with COP 4050 rock drill.



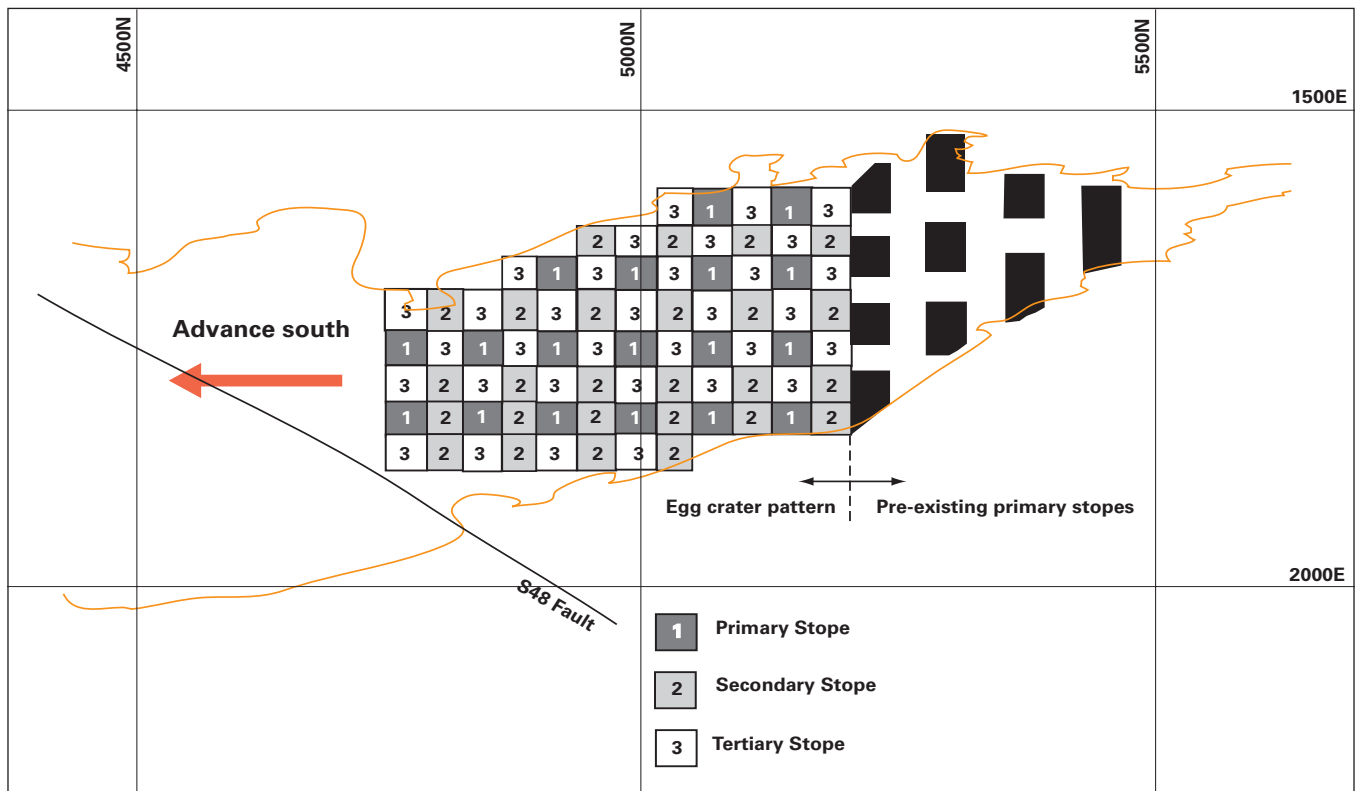

Stoping sequence at Mount Isa mine.

The new orebodies, 1,500-1,800 m below the surface, are accessed by declines from the bottom of the main U62/R62 Mount Isa shaft complex. Central to Enterprise is the new ore handling system, including a 2 km underground conveyor (V63 and M62) and a 713 m-deep, 5.3 m-diameter internal shaft (the M62), which is boosting capacity to extract the high-grade ore. A 2.13 m x 1.98 m jaw crusher reduces the ore down to less than 400 mm pieces at a rate of up to 1,000 t/h. The 378 m-long V63 conveyor carries the crushed ore to the M62 shaft, where it is hoisted to the 20 level. The hoist is controlled from a surface control room, and operates at up to 16.8 m/s. From there the ore is loaded onto the M62 conveyor for delivery to the existing U62 copper ore handling shaft via a short orepass. Commercial production began from Enterprise in July, 2000 following five years of development work. The ore has a high grade of 4% copper, justifying development at such depths. The development is predicted to provide ore for the smelter after 2020, as production from the 1100 orebody declines. Annual production increased to 3.5 million t of

ore by 2004. The other main copper resources at Mount Isa are the 1900 and 1100 orebodies, the latter known also as the X41 mine named after the shaft that reaches the 21 level.

MIM Holdings' lead-zinc-silver comes from the company's lead mine at Mount Isa (Racecourse orebody, etc) and its George Fischer mine. At these mines the lead-zinc-silver ore is mined, crushed and hauled to the surface. Ore from the George Fischer mine is taken via an off-highway haulage road to the Mount Isa facility for processing.

The total extent of the Mount Isa mine workings is now 5 km in length and 1.2 km in width, with the deepest point (Enterprise mine) approximately 1,800 m underground.

## Mining methods

The zinc-lead-silver orebodies and copper orebodies are mined separately, using slightly different methods, although all operations use forms of open stoping. In open stoping, blocks of ore that make up part of the orebody are removed one at a time, with the ultimate goal of removing all of them.

In the Mount Isa copper mine orebodies, sublevel open stoping, coupled with secondary and tertiary stoping is used to extract the ore. Blocks of ore 40 m-wide, 40 m-long at full orebody height are removed. To do this, 5.0 m x 5.0 m drilling sublevels are developed at 40 m intervals. At the bottom of the stope, a number of drawpoints are mined and equipped to extract the ore.

Blast hole drilling is carried out using a variety of Atlas Copco Simba rigs, including models H4353, H1354, 366, 269 and 254. On the extraction level, upholes in a 'V' shape are used to shape the trough. On the drilling sublevel, the Simba rigs are used to drill holes in a radiating fan shape. A slice of ore the height of the stope is extracted first, exposing an open area along one side of the stope, into which progressive blasting is carried out.

The fleet of Simba rigs covers a wide range of hole lengths, diameters and orientation possibilities for flexible orebody exploitation capabilities. Holes can be drilled accurately, with stringent tolerances, for optimum fragmentation of the ore, and minimal underbreak. Top-hammer or ITH (in-the-hole) hammer

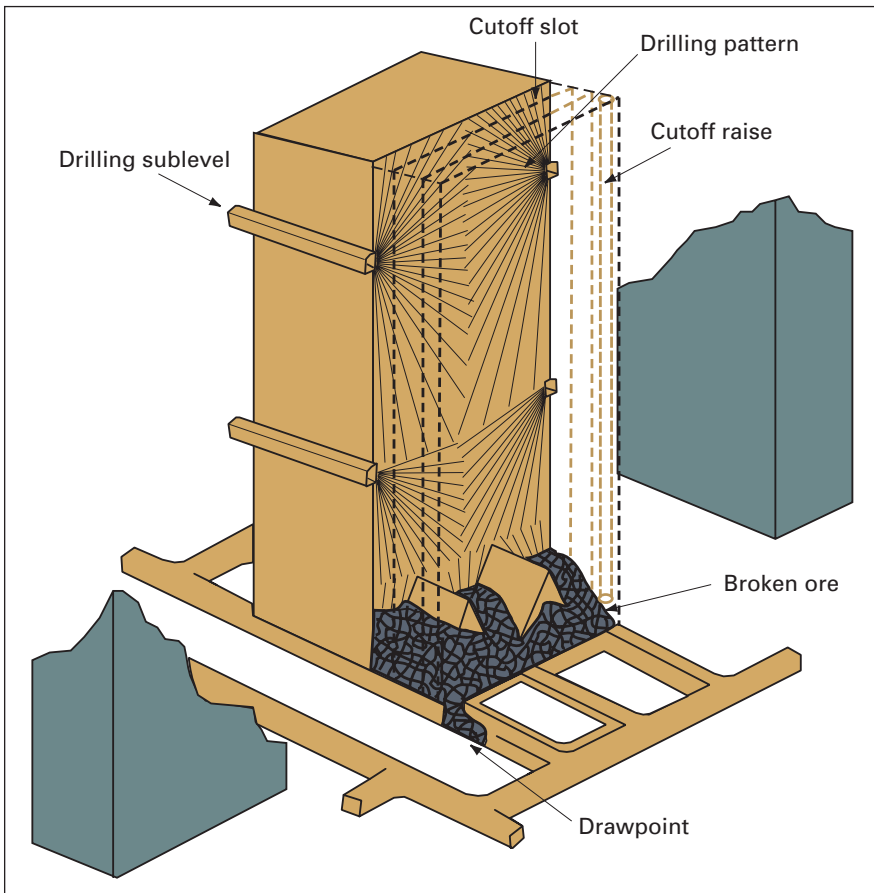

General view of sublevel stoping at Mount Isa copper mine.

drilling is possible for hole lengths of over 50 m. Flexibility of use is promoted by the modular construction of the rigs so that, for example, the feed positioning system can be combined in different ways to obtain the required hole positions and directions. Types of drilling that can be handled include bench drilling, fan drilling within a 90-degree sector, 360-degree ring drilling, and parallel hole drilling.

The Simba H4353, for example, is an all-hydraulic unit for large-scale operations, carrying out 90-degree fan drilling, 360-degree ring drilling, or parallel hole drilling at 1.5 m intervals. The feed beam can be inclined 20 degrees forward and 80 degrees backwards. The hole diameter range is 89–127 mm, to a maximum recommended hole depth of 51 m. Drilling control is automatic, using the Atlas Copco COP 4050 rock drill.

ANFO is the main explosive, mixed on site. It is not uncommon for it to be used to blast 100,000 t in a single firing. The broken ore falls to the bottom of the

stope, and is extracted at the drawpoints by diesel-powered LHD wheel loaders with a 6.1 cu m bucket capacity. Then the ore is either tipped directly into the passes to feed the crusher or, if the stope is a long way from the crusher, into articulated haulage trucks. After crushing, the ore is sent via a 1.6 km cable belt to the U62 hoisting system, where 36 t skips take it to the surface.

Mount Isa aims at 100% extraction so, in this method, pillars between blocks also need to be recovered. To achieve this, open ore stopes are filled with a cement-based slurry and/or rock mixture. The slurry is a mixture of Portland cement and concentrator tailings, whilst the rock is sourced from surface stockpiles, from the heavy media rejects from the lead concentrator, or slag waste from the copper smelter. The mixture sets into a hard, rock-like formation, providing a stable face to enable extraction of the adjacent ore pillar.

Over half of the site's production drilling units are Atlas Copco Simba rigs.

As well as these, Atlas Copco Boomer rigs are used for rockbolting. At Mount Isa, in total, there are 27 drill rigs for development and rockbolting, 17 production drill rigs, 33 LHD loaders, 16 articulated dump trucks for longer haulage, and seven raise drills.

## Zinc-lead-silver extraction

Panel stoping and bench stoping are used in the zinc-lead-silver mine, although sublevel open stoping has been introduced as well, where suitable. Whereas bench stoping involves mining the orebody longitudinally, panel stoping involves mining the orebody transversely. Panel stoping is still an open stoping method, and was considered more efficient for mining the wider orebodies at George Fischer. Bench stoping is still the preferred method for the mine's narrow orebodies.

Prior to the current benching method being introduced in 1992–93, cut-and-fill was used. In the cut-and-fill method, a horizontal slice of ore up to 4 m-high is extracted from the length of the orebody. Although very selective in high-grade ores, the method is also expensive.

Benching was introduced as a safer and more efficient method. The cut-and-fill method requires a lot of ground support, as miners work in the orebody itself. With open stoping, workers are positioned outside the orebody, in a much safer working environment. Despite the larger open void, benching is more cost effective as less support is required, and the ore can be extracted more efficiently.

In benching, horizontal tunnels, or 'sill drives', are driven the length of the orebody at regular vertical intervals. The distance between sill drives depends on local ground conditions, and is typically 15 m. Blast holes are drilled vertically down from one sill drive to the lower sill drive. Starting at one end of the bench, a row of holes is blasted to remove the rock between the two sill drives. The broken ore drops to the bottom of the orebody, and is removed by LHD to the orepass. It is necessary for the loader to go inside the stope to remove the ore, so fill is progressively introduced to the cavity to add stability



to the hanging wall. The fill used on site includes uncrushed underground development rock spoil, heavy media reject from the process plant, or hydraulic sand fill from the surface.

The potential hazards of loading out from within an open stope have been tackled by technical development. With the benching method, teleremote production loading was also brought in. With this system, employing CCTV cameras on the front and back of the LHD, operators can now handle up to three units by remote control from one location. This is an air-conditioned cabin, which may be up to 1 km away. The system saves time spent on a job, increases operator safety, and gives operators more control.

The technology was practically ahead of its time when introduced, because it is still current. It was a step towards the development of today's equipment with built-in navigational systems. Benching has increased productivity, improved safety, reduced costs and provides better utilization of equipment. The extensive mine workings at Mount Isa incorporate a total length of underground openings including road-ways,

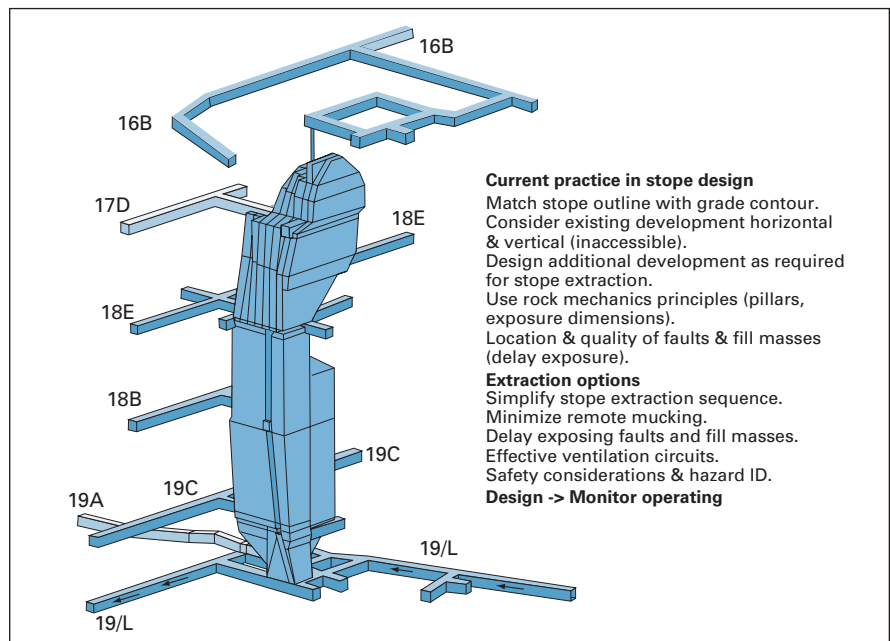

Tailor made stope design at Mount Isa copper mine.

orepasses and shafts, of approximately 975 km. The workings produce 10 million t/year. Most mines have at least one particular form of technical challenge, and at Mount Isa it is heat, due to the great working depths. The virgin rock temperatures are around 60 degrees C.

However, with proper ventilation the mine's wet-bulb temperature is below 23 degrees C. The Mount Isa ventilation system is one of the largest of its kind in the world, and includes bulk coolers on the surface to cool the air before it goes underground.

## Huge savings in drilling consumables



Atlas Copco Secoroc workshop at Mount Isa Mines.

An alliance between MIM and Atlas Copco Secoroc has resulted in a reduction of annual bit consumption from 28,000 to just 11,000, with no changes in tonnages. For more than 15 years, Secoroc had held a supply-only contract for drilling consumables with MIM. When taking over the role of General Manager, they reviewed the contract and found a throw-away culture that, if turned around, had the

potential to markedly save costs and improve safety. The original consumables contract was not providing enough information to the supplier. This realization was instrumental in changing the contract from supply only, to full service and supply. MIM is a very large and busy company, making the focus on drilling consumables difficult.

MIM undertook the task of generating information and sharing it with Secoroc, to release the mutual benefits of reduced costs for the client and contract extensions for the supplier. To foster continuous improvement, quarterly meetings were implemented to discuss the provision of service – prompt reporting of loss, product training and product development. Both parties agree on what has and what hasn't been done, focusing on the objectives. As a result, Secoroc is able to provide the most suitable and

cost-efficient products for MIM operations, resulting in fewer bits for the same tonnages. MIM and Secoroc are now really pushing the idea of reusing material and focusing on wastage. Bit resharpener, rod straightening and rod clearing have been introduced with the resharpener ratio for development bits now averaging 1.5 times.

Consumable care is an area where the jumbo operators can improve the life of consumables and cost per metre, and Secoroc is required to take a lead in education in the use of its products.

The companies are working towards agreeing on and setting expectations about scaling standards, and procedures to reduce damage.

The initial supply and service contract ran for one year and has since been extended for three years on a performance-based rolling contract, with three monthly performance reviews.



## Mount Isa mines – the company



Scooptram loader at Mount Isa.

Wholly owned by MIM Holdings, Mount Isa Mines (MIM) has 2,000 permanent employees at its Mount Isa and Townsville operations, and over

5,800 employees in other operations across Australia and overseas. In addition to the Mount Isa complex, MIM has copper mines at Ernest Henry in Queensland, and a 50% interest in the Bajo de la Alumbrera project in Argentina. For lead-zinc-silver, there is the George Fischer mine (incorporating the former Hilton mine) in Queensland, which uses the Mount Isa and Townsville processing facilities, and a majority interest in the McArthur River mine in Australia's Northern Territories. There is a gold mine at Ravenswood, and extensive coal operations. The latter comprise

coking coal at Oaky Creek, steam coal at Newlands, and steaming and coking coal at Collinsville. There is also coal shipping from Abbot Point and Dalrymple Bay, and a coking plant at Bowen Basin. All are in Australia.

MIM's sources of revenue from all mines are split by products: copper 31%; by-product gold 8%; Ravenswood mine gold 1%; zinc 18%; lead 8%; silver 4%; coal 30%.

Markets for Mount Isa's copper are Australia (33%), Asia (53%); and Europe (14%). Mining finance group Xstrata owns MIM Holdings.

## Ore processing

Lead-zinc-silver ore from Mount Isa and George Fischer mines is ground to a fine powder at the Mount Isa facility, after which a flotation process is used to separate waste, and produce lead-rich and zinc-rich concentrates.

Lead concentrate from Mount Isa contains 50-60% lead, and around 1 kg of silver/t. After smelting to remove further impurities, blocks of material, each containing approximately 3,984 kg of lead and 10 kg of silver, are transported by rail to Townsville for shipment to MIM's lead/silver refinery in England. In 2001-2002, lead-zinc concentrator throughput and recovery increased, and there was improved plant reliability at the lead smelter.

Around 51% zinc concentrate is also railed to Townsville for refining, or shipment to overseas customers. MIM currently produces approximately 190,000 t of lead bullion and 500,000 t of zinc concentrate each year.

At the Mount Isa processing facility, there is a chimneystack at the copper smelter, built in 1955, which is 155 m-high, and at the lead smelter the stack,

built in 1978, is 270 m-high. Copper is produced electrolytically in the form of anodes. Each weighs 375 kg and is 99.7% pure copper.

## Expansion plans

In the year ending June, 2002, record copper smelter production of 233,000 t of anode was achieved. This was up from 207,000 t for the previous year.

A recent copper study to improve reserves and efficiencies has resulted in an increase in reserves to 12 years. This has led to a planned 40% expansion in copper production by 2006. A rate of 400,000 t/y for up to 20 years from Mount Isa and MIM's Ernest Henry Mine is predicted by MIM.

MIM is planning to expand copper production by developing the 1900 orebody, the Enterprise Mine 3000 and 3500 orebodies, and the surface open pit mines in and around existing orebodies. The aim for 2003 was to increase Mount Isa copper production to 245,000 t, improve the recovery rate in the concentrator following an upgrade, and increase plant utilization by improving maintenance practices. It is estimated

that Mount Isa has over 6 million t of contained copper still to be mined, more than has been extracted over the past 60 years.

In more detail, the 2002 reserves and resource report gave a total of proved and probable ore reserves of approximately 73 million t at 3.3% copper (previously 47 million t at 3.6% copper). The total underground measured, indicated and inferred resources, including reserves, were approximately 116 million t at 3.3% copper (previously 88 million t at 3.7% copper). In addition there were a total open-cut indicated, inferred resources of 255 million t at 1.2% copper (previously an inferred resource of 112 million t at 1.6% copper).

The improved lead-zinc concentrator performance and smelter reliability in 2001-2002 contributed to an increase in production from 140,000 t to 161,000 t and reduced operating costs. Still, MIM is planning to reduce off-site realization costs such as transport and smelting, which represent up to 60% of total production costs at present.

## Acknowledgements

*Atlas Copco is grateful to the management of Mount Isa Mines, and in particular to Jim Simpson, General Manager Mining, Lead Zinc, for writing this article which first appeared in Underground Mining Methods, First Edition.*

Table: Mount Isa mine life production statistics

Resource	Tonnage (million t)
Total lead-zinc ore mined and processed	100
Total copper ore mined and processed	200
Total copper resource remaining	400
Total lead-zinc resource remaining	200



# High speed haulage at Stawell

## Keeping on track

Trucking ore from a depth of one kilometre beneath the surface can be a slow and expensive process, but it's a thing of the past for the Stawell Gold Mine in Australia, where high speed haulage using a fleet of the latest Atlas Copco Minetruck MT5010 and MT6020 trucks plays a major role in the operation. Getting the ore out involves a long drive up the sublevel ramps at 1:8 to the 400 m level, and then on an incline of 1:10 to surface, a journey of 8-9 km. The drivers report that the mine trucks is the smoothest ride in their experience, and the management is obtaining their lowest-ever cost/t. The mine trucks are providing a very good return on investment!

## Long history

Stawell Gold Mine, located about 250 km west of Melbourne, was first mined in 1853. It was closed in 1926, and stayed dormant for more than 50 years. It then re-opened in 1982, and has been in operation ever since.

From 1992 until 2005, Stawell was owned by MPI Mines, who instituted a plan to increase gold production from 100,000 oz/yr to 130,000 oz/yr by end-2006.

However, the mine recently changed hands, and is now operated by Leviathan Resources, who have adopted the same objective. To meet these targets, bench stoping with cemented rock fill pillars in primary stopes is used. With this mining method, approximately 80% of the ore is recovered from the stopes. Remote-controlled loaders shift the ore out of the stopes, from where four Atlas Copco MT5010 trucks are employed hauling it to the surface along a gravel roadbed maintained by two graders in continuous operation. A Minetruck MT6020 was recently added to the fleet.

Stawell management is convinced that their MT5010 and MT6020 trucks are the best on the market in terms of load capacity and performance.

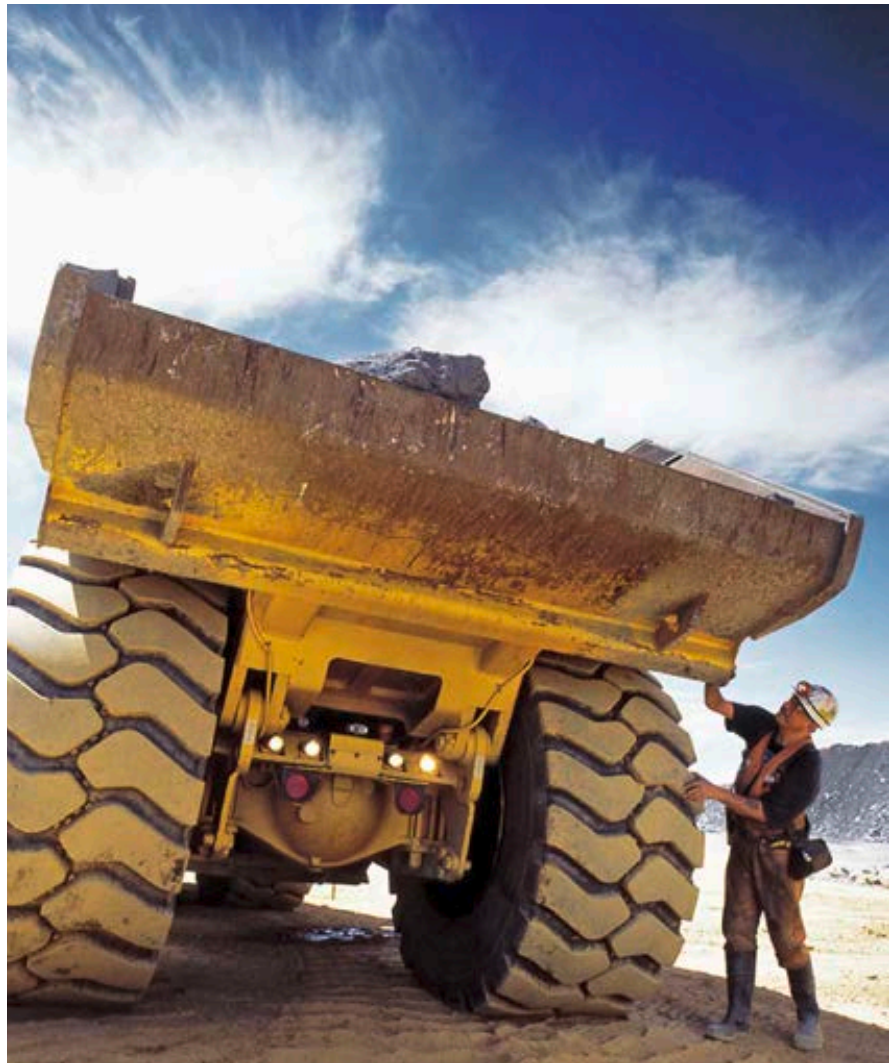

Visual inspection of a Minetruck MT5010 with full load near Stawell portal.

## Faster is better

Stawell is a very deep mine with incline access. Inevitably, the adit is the bottleneck in the production operation, because it limits the size of truck that can be employed hauling ore to surface. However, within the normal underground speed constraints, the faster the trucks, and the cleaner they run, the greater will be the amount of ore that gets to surface.

At Stawell, getting the ore to surface involves an 8-9 km drive, which, even with Minetrucks, involves a round trip of 100 minutes. On the 1:8 gradient, speed under full load is 12 km/h, some

2-3 km/h faster than the next fastest truck on the current market.

This is because the MT5010 and MT6020 have the greatest power-to-weight ratio of any truck in their classes, giving them the highest possible travel speeds per tonne.

Based on the success of the site's first MT5010, commissioned in 2003, the mine subsequently ordered another three, with the latest arriving on site in early January, 2005. The MT6020 has since been added. Together, the new fleet has helped Stawell to its medium term objectives while reducing the mining cost/tonne to the lowest it has ever been.

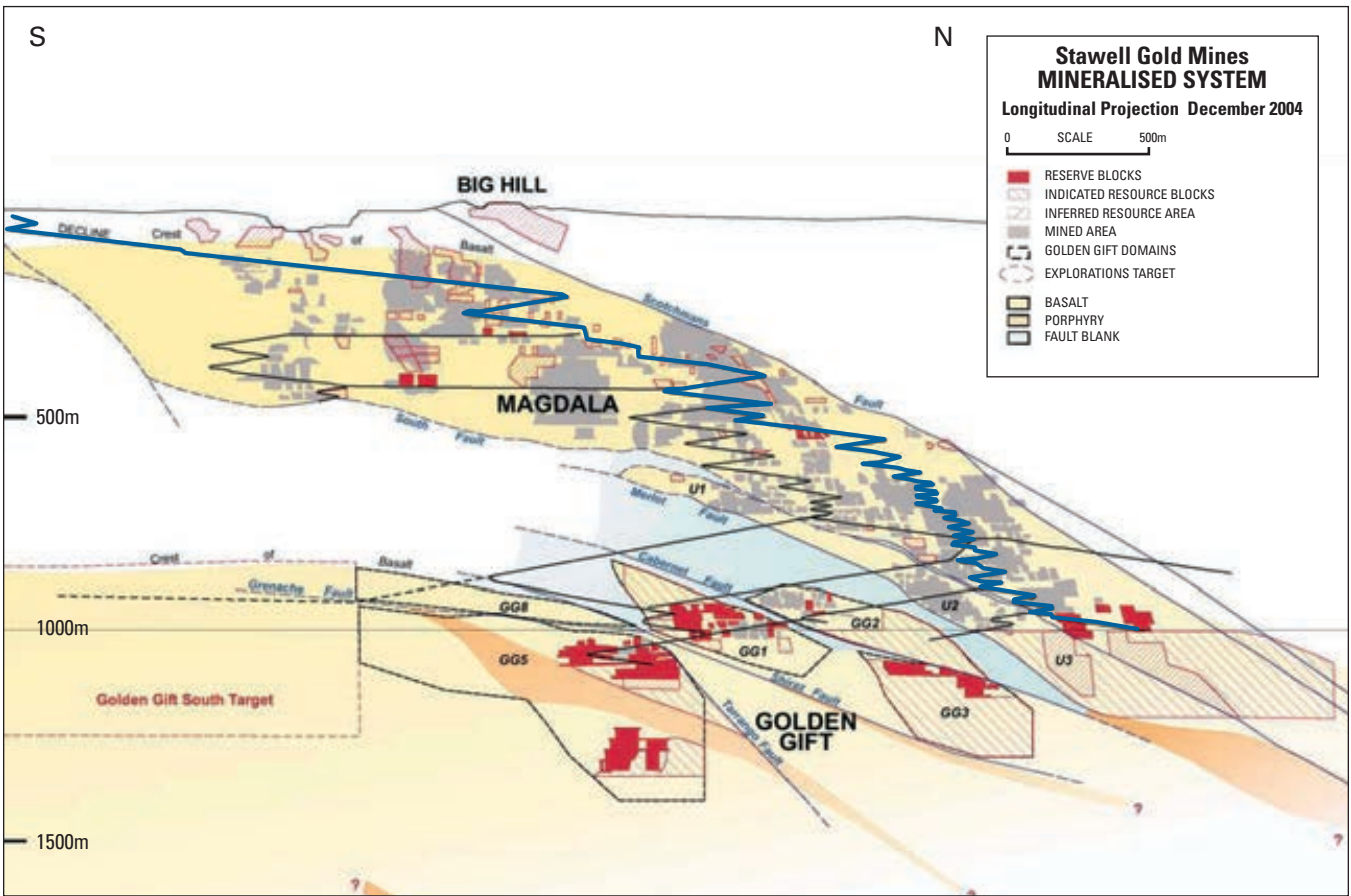

Getting the ore out at Stawell involves an incline of 1:8 to the 400 m level and then 1:10 to surface.

### Minetruck MT5010

The Atlas Copco Minetruck MT5010 truck is currently offered with the

Cummins QSK-19-C650 engine as standard. This water-cooled diesel provides an MSHA power rating of 485 kW (650 hp) at 2,100 rpm, has a displacement

of 19 litres (1,159 cu in) and a six-cylinder, in-line configuration. It is designed for maximum utilization with minimum maintenance. The articulated pistons are made to last 30% longer, and also give 30% longer life after the engine's first rebuild. Oil seals have been engineered so they are never exposed to contaminants.

One of the four MT5010 mine trucks at Stawell Mine with manager Bill Colvin and driver Bruce Mclean.



The MT5010 is equipped with an air-conditioned ROPS/FOPS-approved cabin with forward-facing seat and back-up video monitor, and has an active hydraulic suspension system for improved operator comfort and handling. Indeed, Stawell operators report that the MT5010 suspension is the most comfortable in their experience and provides a much softer, smoother ride. They observe that, when working 12-hour shifts, this makes a huge difference. The cab is also set up for efficient operation, with good driver visibility, clear instruments, and all controls easy to reach.

One of the most noticeable and impressive features of the MT 5010 truck is its power. The Cummins engine delivers





The Minetruck MT5010 exits from the Stawell portal after a 9 km uphill drive.

torque of more than 3,000 Nm through the six-speed automatic transmission. From a standing start under load it pulls extremely well, whereas vehicles from the previous fleet struggled. It also has a tight turning circle, saving on backing out trucks in the limited space underground, and is a lot less tedious to drive, being much faster than the old machines.

The engine on the MT5010 is electronically controlled for maximum fuel efficiency, minimum exhaust emissions and continuous diagnostic monitoring. This control system, along with an electronic transverter, provides smooth and precise gear changes.

In addition to the selection of Cummins as the engine supplier, Atlas Copco has put the MT5010 through a series of more than 40 performance-enhancing upgrades to the engine, powertrain, cab, suspension, structural body, and systems,

which dramatically increase engine and component life. Servicing is fast and simple, thanks to easy access to filters, test points, and other parts which require regular maintenance.

### **Minetruck MT6020**

The Atlas Copco Minetruck MT6020 is a fast all-wheel drive 60 metric ton capacity articulated underground truck, with an ergonomically designed forward seating enclosed operator's compartment for unparalleled productivity in demanding mines. The cabin is ROPS and FOPS certified for maximum safety and minimal operator fatigue. It is air conditioned, and has a tilt-telescopic steering wheel, back up camera monitor, and trainer seat. The vehicle features an optimum box profile for clean and fast dumping, and its front axle suspension has a gas-hydraulic system to

minimize frame stress while improving operator comfort and vehicle handling. The powertrain includes an upbox and a combined transmission and converter for improved visibility and accessibility to components, which, with the engine control system, provide smooth and precise shifting. The vehicle has individual self-levelling suspension.

The Minetruck MT6020 has a high power-to-weight ratio, using less horsepower while offering the highest speed per tonne in its class. Power is provided by a proven Cummins QSK19-C760, Tier/Stage 1 engine with power rating at 2,100 rpm of 567 kW/760 hp and maximum torque at 1,300 rpm of 3,084 Nm.

The Allison M6610AR planetary automatic transmission has six forward speeds and two reverse, with an integral single stage converter with automatic lock up. Fully enclosed, force cooled, multiple wet discs operate at each wheel



*Minetruck MT6020 during the field test at Stawell Gold Mine in Australia.*

end. Fuel tank capacity is 644 litres, and fuel consumption at full load is 67 litres/hour.

The Minetruck MT6020 is 11.23 m long and 3.44 m wide at the rear, and has a turning angle of 42.5 degrees. It operates best in a minimum drift size of 5 m high x 5.5 m wide.

### **Continuous support**

The routine performed by the mine's maintenance team includes checking main functions after each 12-hour shift, as well as more thorough services at 125 hours, and the recommended intervals at 250 hours.

The Minetrucks, despite their arduous working situation, are acknowledged by Stawell management as being the best performing trucks on site, with the highest t/km and excellent availability. As a result, they now constitute 70% of the hauling fleet.

Where problems have been experienced, the mine knows it can rely on support from Atlas Copco. If they need a part, or a question answered, Atlas

Copco provides a true, 24-hour service, seven days a week, and treats every enquiry with the correct degree of urgency.

A technical training course on the Minetrucks was conducted at the mine by Atlas Copco to further enhance the expertise of the maintenance staff. Many of the participants reported back that it was the best on-site training they had ever received from any equipment supplier, observing that Atlas Copco understands that aftermarket service and support is an important complement to

any sale. Future plans at Stawell include further exploration and deeper development work. In the next four to five years it is planned to increase the mining depth to at least 1,300 m.

### **Acknowledgements**

*Atlas Copco is grateful to the management and staff at Stawell mine for their assistance in the production of this article.*

*Loaded Minetruck MT6020 during the field test at Stawell Gold Mine in Australia.*





# Sublevel stoping at Olympic Dam

## Rapid expansion

Since discovery of the massive Olympic Dam orebody in 1975, and the establishment of the mine in 1988, the complex has been through a series of rapid expansion programmes. Owned and operated by BHP Billiton, it is the largest single underground mine in Australia, with a production rate of 30,000 t of ore per day to produce around 185,000 t of copper product annually and significant quantities of uranium, gold and silver. Total mineral resource underground is 3,810 million t grading 1.1% copper and 0.4 kg/t uranium oxide. The mine's staged expansion has been run in parallel with a philosophy of continuous improvement of mining methods. They employ a fleet of Atlas Copco Simba rigs for down-hole production drilling within a carefully planned and controlled sublevel stoping method of production.

## Geology

The Olympic Dam mineral deposit consists of a large body of fractured, brecciated and hydrothermally altered granite, a variety of hematite-bearing breccias and minor tuffs and sediments. The breccia lies under 300-350 m of barren flat-lying sediments comprising limestone overlying quartzite, sandstone and shale. The deposit contains semi-discrete concentrations of iron, copper, uranium, gold, silver, barium, fluorine and rare earth elements. These are scattered throughout an area 7 km-long and 4 km-wide, and having a depth of over 1,000 m. There are two main types of mineralization: a copper-uranium ore with minor gold and silver within numerous ore zones, making up most of the resource; and a gold ore type which occurs in a very restricted locality.

There is distinct zonation evident throughout the deposit, ranging from iron sulphide (pyrite) at depth and

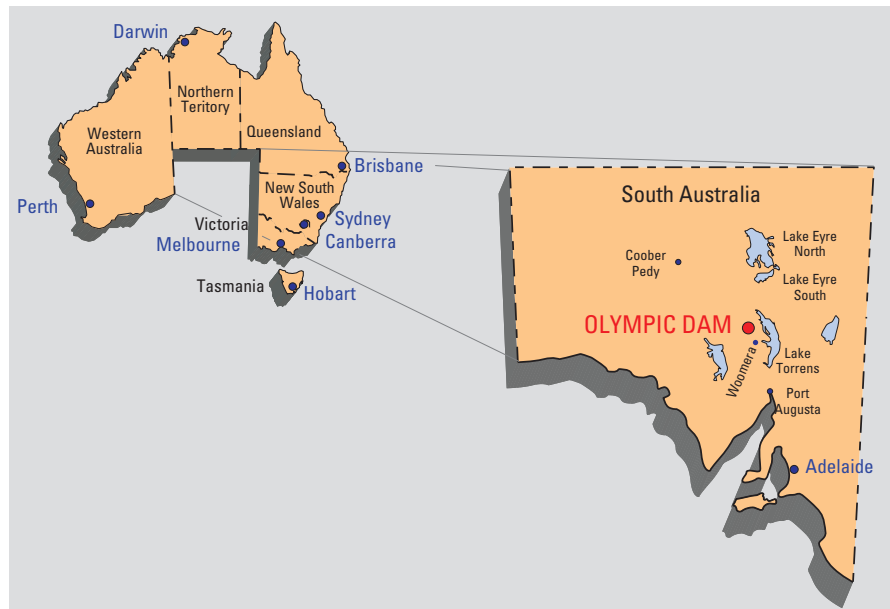

*Olympic Dam location in South Australia.*

towards the outer edges of the deposit, through to copper-iron sulphides and increasingly copper-rich sulphides towards the central and upper parts of the deposit. The zonation can continue with rare native copper through to gold-enriched zones, and finally into silicified lithologies. Uranium occurs in association with all copper mineralization. The predominant uranium mineral is uraninite (pitchblende), but coffinite and brannerite occur to a lesser extent.

Virgin rock stress conditions are comparable in magnitude with most Australian mines, with the principal stress horizontal and approximately 2.5 times greater than the vertical stress, due chiefly to the weight of overlying rock.

With few exceptions related to weaker areas, the workings are generally dry. In-situ rock temperatures range from 30 to 45 degrees C.

## Mine programme

The Olympic Dam mine comprises underground workings, a minerals processing

plant, and associated infrastructure within a mining lease area of 29,000ha.

Situated 80 km north of Woomera, and 560 km north-north-west of the South Australia state capital of Adelaide, the mine has sufficient estimated reserves for a possible life of 70 years within current rates of production, although the actual mine plan is in place for only 20 years at present. The mine has its own purpose-built town, Roxby Downs, located 16 km away. There are around 980 employees, of which 490 work in mining, and there are also 400 contractors on site.

Access to the mine is through a 4 km long surface decline and three shafts: the Whenan shaft, which was the original exploration access, converted for hoisting; the Robinson shaft, sunk in 1995; and the new Sir Lindsay Clark shaft.

The last completed expansion stage results from a feasibility study carried out in 1996 that recommended an expansion of ore output from 3 million t/year to 9 million t/year. The facilities for this expansion were completed in

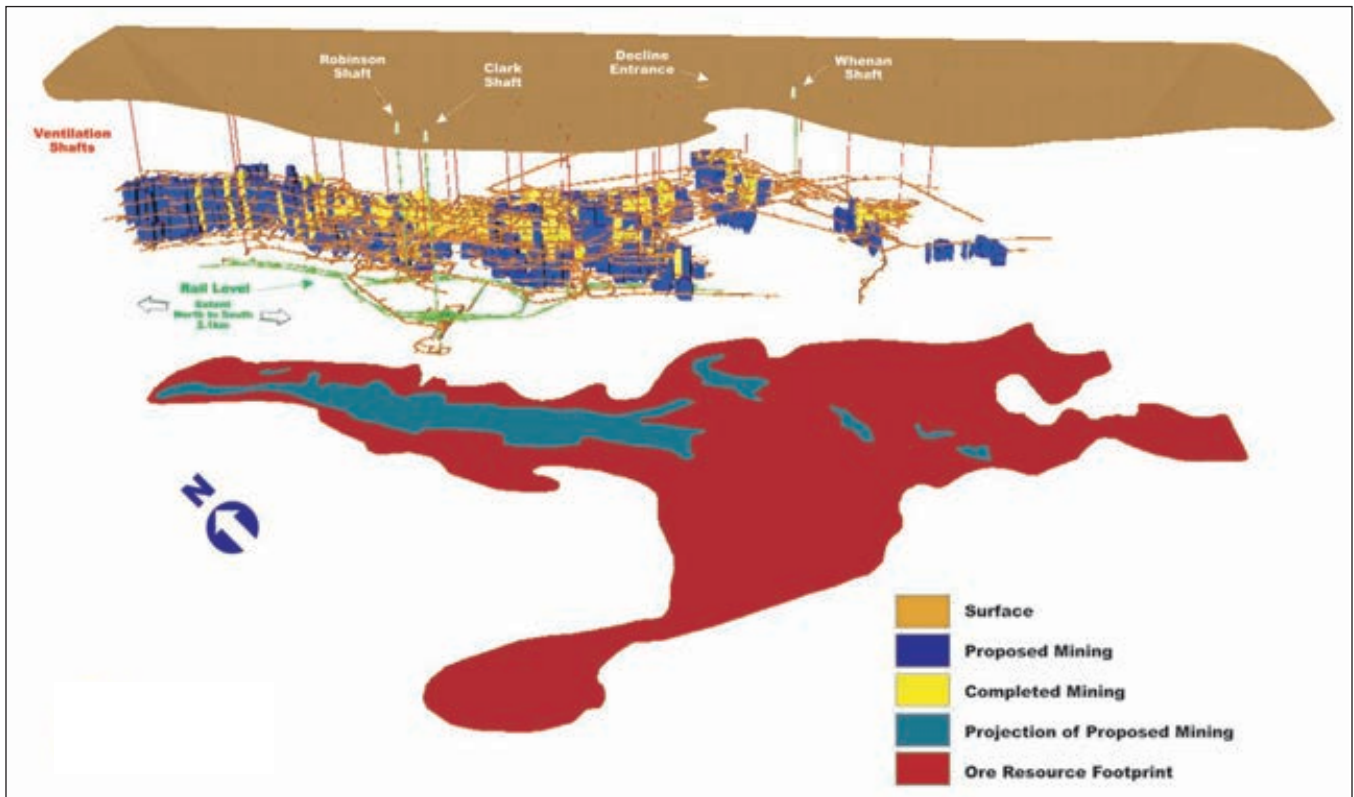

Olympic Dam mine exploration.

1999 at a cost of Aus\$1,940 million. They included an automated electric rail haulage system (based on that at the LKAB Kiruna mine), a new underground crusher station, a third haulage shaft (the Sir Lindsay Clark), a substantial increase in ventilation capacity, a new smelter, and an enlarged hydrometallurgical plant. The Sir Lindsay Clark shaft is fitted with the largest mine winder in Australia, both in terms of power (6.5 MW) and hoisting capacity (13,765 t/h). These facilities increased the annual production capacity to 200,000 t of refined copper, 4,300 t of uranium oxide, 75,000 oz (2.33 t) of gold and 850,000 oz (26.44 t) of silver.

Further expansion under the Optimisation Phase 3 plan in 2003 increased copper production to 235,000 t/year.

Since 1988, more than 100 km of underground development has taken place to facilitate the production of more than

17 million t of mined ore. As of December, 2000, ore reserves were predicted to be 707 million t, with average grading of 1.7% copper, 0.5 kg/t uranium oxide, and 0.5 gm/t gold.

The mine's revenue is made up from sales of copper (75%), uranium (20%) and gold and silver (5%). Copper customers are based in Australia (26%), Europe (16%), northern Asia (28%) and south-east Asia (30%). Uranium is sold to the United States (54%), Japan (23%), Europe (22%) and Canada (1%).

### Mining method

A carefully sequenced and monitored method of sublevel open stoping is employed to extract the ore. This was chosen chiefly on the basis of: the depth of the orebody and volume of overburden; the large lateral extent of the orebody; the geotechnical attributes of the ore (see above), the host rock and barren materials,

as well as their geological distribution; the grade and volume of the ore; the mine's production requirements.

This type of mining is most suitable for large ore zones that are characterized by relatively regular ore-waste contacts and good ground conditions. At Olympic Dam, the method features the development of sublevel drives, usually at 30-60 m vertical intervals. From these sublevels, a 1.4 m-diameter raise hole is excavated by contracted raiseboring. This extends the whole vertical extent of the designated stope. Production blastholes of 89-155 mm-diameter are then drilled in ringed fans, or rows parallel to the ore limits. Planning engineers, in consultation with the drill-and-blast engineer, develop the patterns using the Datamine Rings software package. The normal hole parameters are 3 m overburden and 4 m toe spacing.

A powder factor of 0.25 kg of explosives per tonne of ore is generally maintained. Blasts range in size from about 500 t, when opening an undercut slot, to 250,000 t for the maximum stope ring firing. There are six to ten blasts/week. Charging is carried out by two 2-man

World ranking of Olympic Dam mine			
Metal	Resource ranking	Production ranking	% of world production
Copper	No.5	No.17	1.4%
Uranium	No.1	No.2	11%

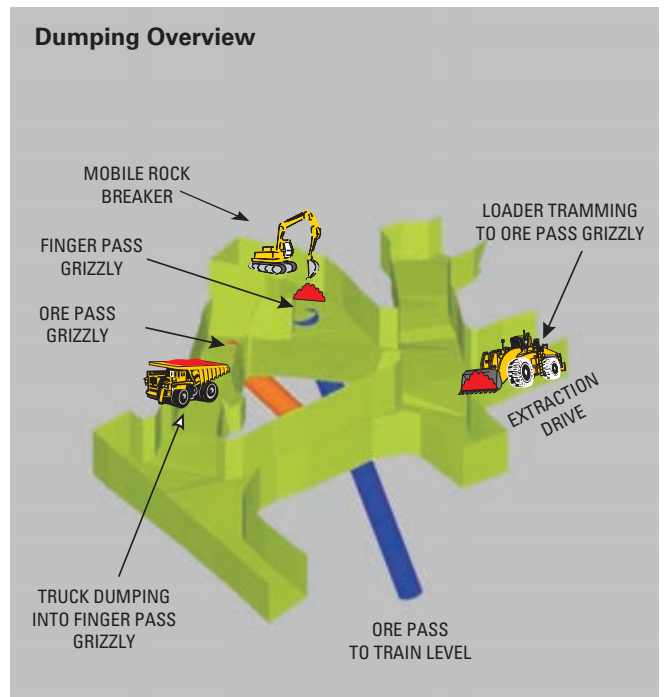
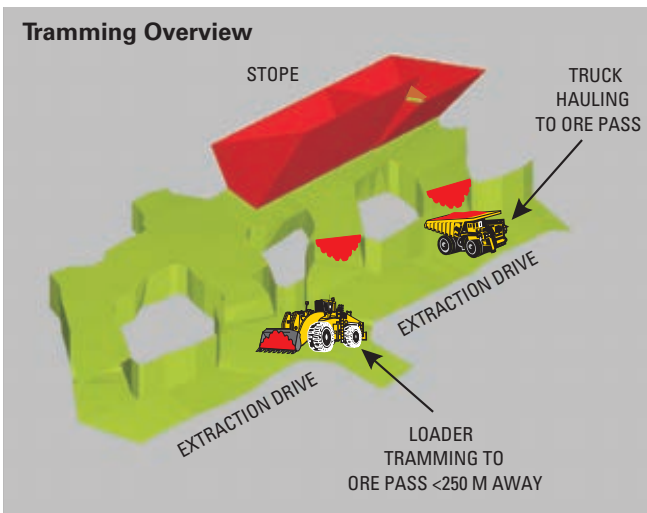
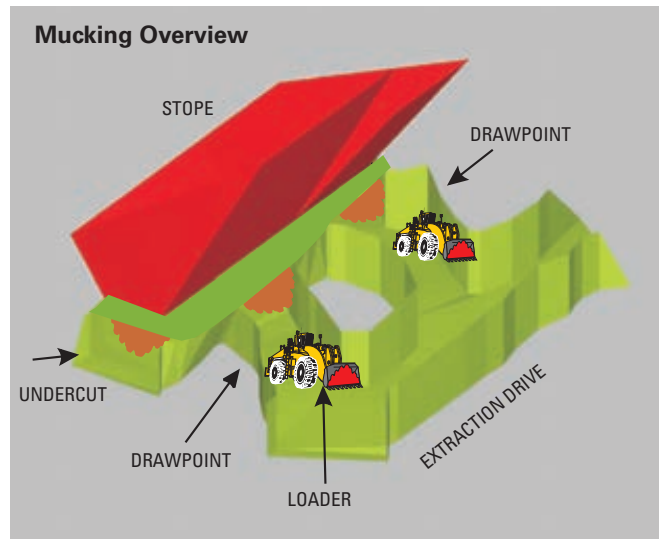
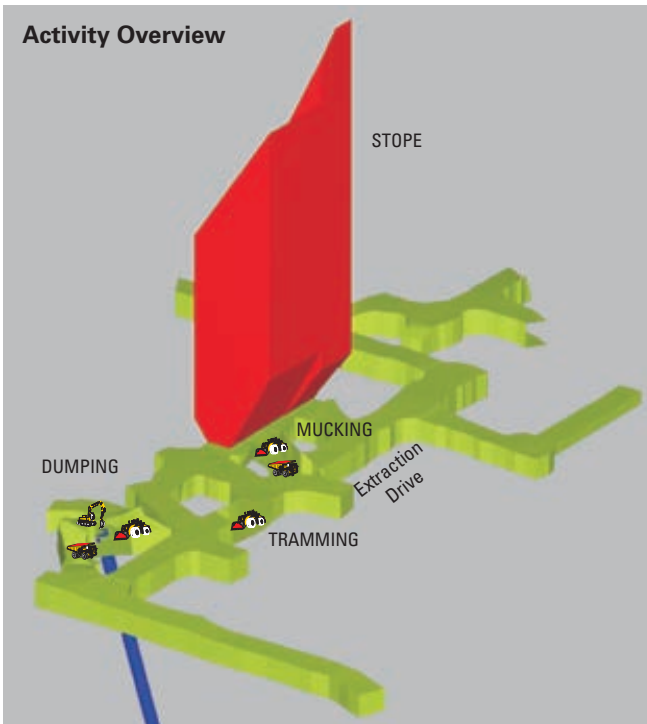

Activity overview showing mucking, tramming and dumping of ore from a typical stope.

crews, working 14 shifts/week. Firing is carried out by a remote initiation system using an electromagnetic field link controlled by PEDCALL software from a desktop computer. Called BlastPED, the system has improved the reliability and safety of blasting. The maximum transverse width (across strike) and length of the stope have been determined as 60 and 35 m respectively.

The stope length (along strike) is generally based on mineralization, geological discontinuities, and other geotechnical issues such as in-situ stress distribution, possible stope geometry and

stope filling. The stope crowns are generally domed to maximize stability. Perimeter drives are located a minimum of 1.5 m away from stopes.

The stopes are laid out by mine design engineers in consultation with the area mine geologist, and then presented to the operating personnel. This is intended to gain formal approval from underground production, development and services departments, so providing a forum for continuous improvement. A final document incorporating any recommendations is then issued, so that everyone is aware of the agreed stope

development procedure and all relevant data such as drill-and-blast design layouts, firing sequences, ground support designs, backfill design, ore grades, structural controls, and ventilation sequencing.

### Extraction and filling

WMC employs Atlas Copco Simba 4356S electro-hydraulic rigs for downward blasthole drilling, whilst upholes are avoided as much as possible. Mining usually commences at one end of the stope, and from one sublevel to the

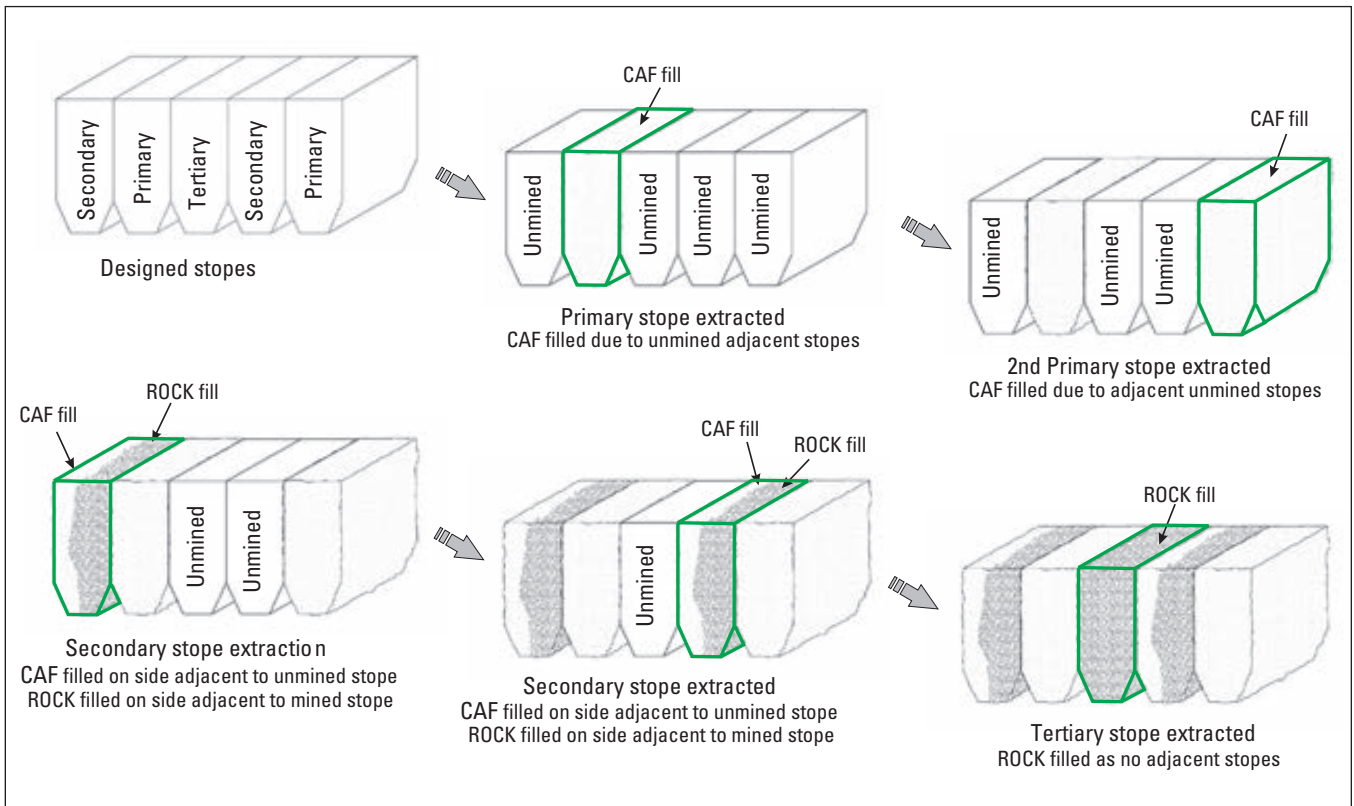

Stope extraction and filling sequence.

next, until the stope is completed. Once drilling is complete, the stope is fired

in stages to ensure maximum fragmentation and minimum dilution of ore.

Ore progression from stope to train level.

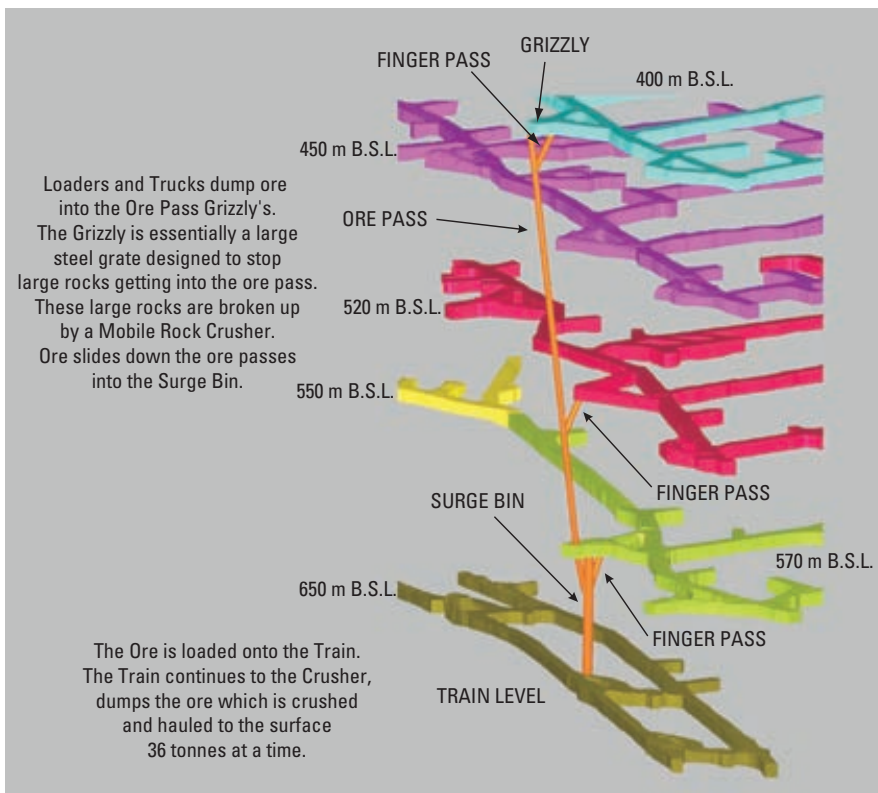

First the slot is formed around the raise-bored hole, and then subsequent blasts peel away the ore into the void. Sufficient broken ore has to be removed by loader from the bottom sublevel of the stope at the footwall to allow for swelling of the rock and the next firing stage.

The extraction process continues in this way, and then all broken ore is removed leaving a roughly rectangular prism-like vertical void, which is then backfilled. The broken ore is transferred to one of the permanent, near vertical, orepasses linking the extraction levels with the rail transport level. These load minecar trains, which carry the ore to the underground crusher and shaft hoist system.

The optimum geotechnical dimensions of the unsupported open stope are usually insufficient for complete extraction of the suitable ore at that position, so a series of secondary, and maybe tertiary, stopes have to be developed adjacent to the primary stope. This necessitates a substantial structural fill for the primary stope, to ensure the structural security of the adjacent stopes without leaving a pillar. This comprises



a cement aggregate fill (CAF) produced on site. Later stopes, which are not critical in geotechnical terms, can be restored more economically with unconsolidated rock fill, or a combination of both.

Other factors determining the use of CAF include planned future development within the stope, and/or a need for a tight fill to the crown of the stope.

Since CAF forms a substantial proportion of the mining costs, mine development plans usually try to minimize the size of primary stopes in favour of larger secondary stopes, which use unconsolidated fill.

This is particularly important in areas where the orebody is relatively narrow. If the primary stope is not filled with CAF, and adjacent stopes are then required, a pillar, generally 10 m-wide, is left between the two. Additional support of the stope crown may be required, and this is carried out by cable bolting. This is also used to reinforce drawpoints.

Careful sequencing of the stope extraction programme is an important feature of mining at Olympic Dam, for economical mining and minimal ore dilution. The sequence is determined by several factors, including ventilation capacity to remove radon gas and other contaminants, the grade and tonnage requirements of the mill, and the proximity of any unfilled stopes. The XPAC Autoscheduler computer software package has been introduced to improve the efficiency of the sequencing process.

### Pride of Simba rigs

Atlas Copco has had a fleet of Simba 4356S machines at Olympic Dam since 1992, and has had a service contract on site supporting and maintaining the fleet since 1994. The machines consistently achieve high levels of productivity and availability at a minimal cost. The Simba rigs are predominantly used to drill downhole production blast holes for the stopes. Their average mechanical availability is 88-92%, and they drill between 8,629 m and 9,359 m/month.

Drill-and-blast methods are also used for main drive developments, and for roof bolting as necessary, or in the rehabilitation of old mining areas re-entered.



Simba 4356S longhole drill rig with COP 4050 tophammer rock drill.

Olympic Dam mining and production statistics	
Description	Amount
Underground development drives (2000)	1,100 m/month
Producing stopes each month (2000)	24
Average stope size (2000)	300,000 tonne
Average stope production rate (2000)	30,000 tonne/month
Average stope production time	Ten months
Average stope filling time	One month
Average stope fill curing time	Three months
Copper production (2002)	178,523 tonne
Uranium Oxide production (2002)	2,890 tonne
Gold production (2002)	64,289 oz
Silver production (2002)	643,975 oz

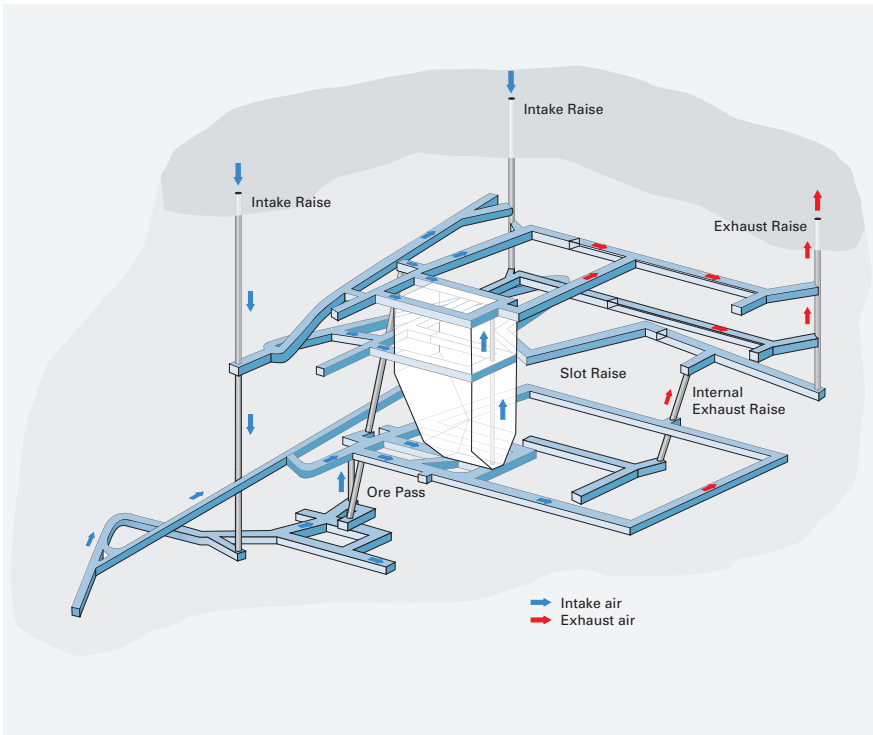

Typical stope ventilation flow layout.

Load-haul-dump (LHDs), wheel loaders and a trucking fleet, as well as the automated rail haulage system, make up transport system at the mine. The rail system transports ore from surge bins to an underground crusher. A computer located in a central control room controls all operations. After crushing to around 150 mm, ore is hauled in 36 t skip buckets to the surface ore-blending stockpile for processing.

## Mine planning

Extensive site investigation, analysis of rock properties, and computerized planning and control procedures aid mine management in the most efficient exploitation of reserves. The programmes are discussed at meetings with relevant line managers to be agreed or modified, before implementation.

As geotechnical conditions are so important for stope stability, the materials properties of the intact rock have been determined from more than 200 laboratory tests. A three-dimensional model of estimated Uniaxial Compressive Strength (UCS) has been developed for the resource area. Evaluation of drill core logs indicates that the mean structural spacing is greater than 6 m,

so the general rock mass condition can be regarded as 'massive'. Jointing is also uncommon, but some faults have been identified. The most significant have sericite filling of <10 mm size. Continuous natural structures that may reduce excavation predictability are increasingly being digitized for further analysis. A new process is being used to transfer geological data to 3-D digital models.

The mine development schedule includes the sequencing of stope development, but is also based on a combination of copper and uranium grades, copper/sulphide ratio, ventilation, and orepass use. Ventilation is particularly important, as current underground mining practices are primarily governed by sufficient ventilation resources to handle radon. Other air contaminants are heat, diesel fumes and dust. Each ventilation district, including its own intake and exhaust (return) air routes, has the capacity to operate two to four producing stopes at a time.

A five-year production schedule is evolved in a spreadsheet format using the area stoping sequence. This is used as the basis for scheduling other mine activities. The operations department carries out short-term scheduling on a three-month rolling basis.

## More expansion ahead

The Optimisation Phase 3 expansion programme was carried out over three years to 2006, looking at mining factors such as: loader performance; stope design; fragmentation and productivity; rail haulage reliability and interfaces; and exploration to improve ore quality and optimize infrastructure.

Studies of options for further expansions to Olympic Dam's operations are underway in 2007, due to exploration work indicating that the orebody will support a doubling of output. This will help meet future long-term global demand, which has expanded significantly over the past few years. An open pit mine is the current preferred option to achieve the proposed capacity increase because of the scale of the orebody. However, a two-year prefeasibility study includes the examination of a broad range of alternatives, with expansion planning split into five key stages to be carried out over a 7-year period to production ramp-up.

## Acknowledgements

*Atlas Copco is grateful to BHP Billiton and the management at Olympic Dam mine for their kind assistance in the preparation of this article.*





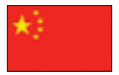

# Improved results at Meishan iron ore mine

## Bright future

China is rich in natural resources, and is already the fourth largest gold producer in the world. This vast country has abundant deposits of copper, lead, zinc, iron and other minerals, not to mention huge reserves of coal, oil and gas. As more mines adopt mechanization, China's potential as a world-class mining nation continues to grow. An operation that typifies the trend in productivity and efficiency improvements is the Meishan underground iron ore mine, near Nanjing. Having been a limited producer for many years, Meishan is now showing significantly improved results, thanks to enlightened management, backed by Atlas Copco equipment.

## Late starter

China began to stake a claim on the international mining map at the start of the 1990s, with a determination to introduce mechanization, coupled with a strong desire for reform and commercial success. Today, more than ten years later, Chinese mines are reaping the benefits that modern mining equipment and methods can bring.

Shanghai Baosteel Group Corporation, a state-owned company set up in 1998, has an iron production of 20 million t/y. Amongst its suppliers is Meishan iron ore mine, one of its subsidiaries.

Meishan is widely regarded as a model mine by the Chinese iron ore industry, and the equipment and methods it uses, most of which are supplied by Atlas Copco, are constantly being monitored and adopted by others around the country.

Situated on the Yangtze River Delta, some 320 km from Shanghai, Meishan is the second largest underground ferrous metals mine in China, with raw



*Meishan mine portal.*

*Rocket Boomer 281 at Meishan.*





Wagner service truck doing the rounds of the mine.

ore output of 4.25 million t in 2006, reflecting a steady increase of 10% each year.

The Meishan orebody, which is more than 100 m below the surface, is 1,370 m-long and 824 m-wide. It has a maximum thickness of 292.50 m and a minimum thickness of 2.56 m, giving an average

thickness of 134 m. The deposit is estimated to contain reserves of 260 million t of predominantly Fe<sub>3</sub>O<sub>4</sub> iron ore.

The mine entrance is located 37 m above sea level (ASL), where the first phase of development got underway in 1975, and the ore is currently mined at -243 m ASL.

## Development

Phase One of the Meishan development plan comprised shaft development, underground stoping and sublevel caving. There are six shafts, three for hoisting (main, secondary and southwest), and three for ventilation (south, southeast

Idealized long section of mine.

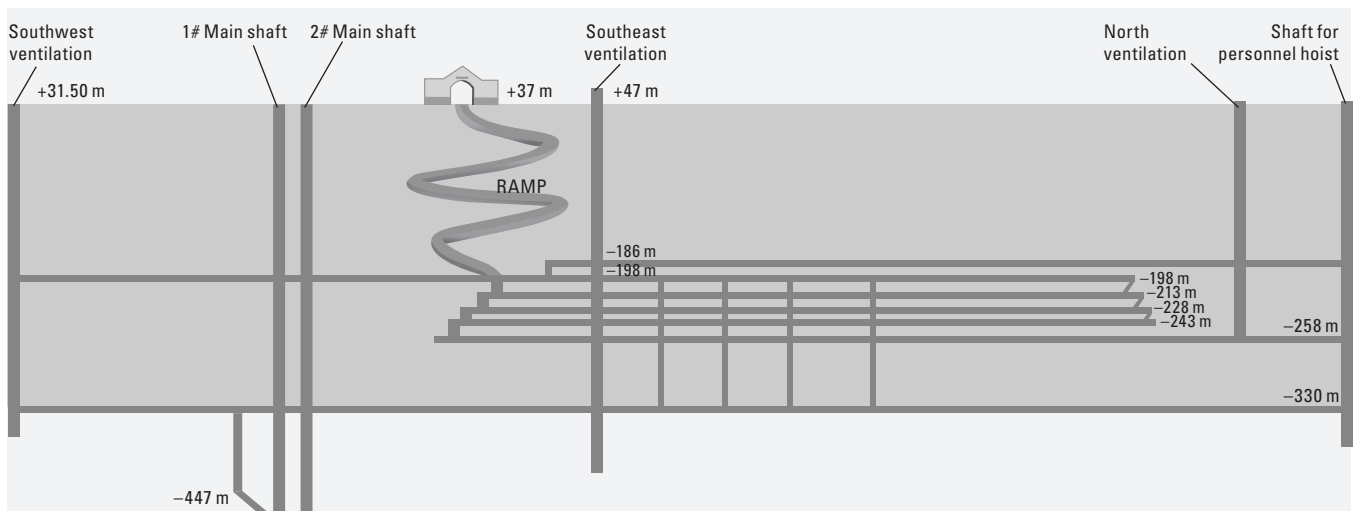

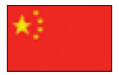

Simba production drill rig, one of six at Meishan.

and west). The main ramp, built in 2000, is connected at its lower end to the horizontal mining area at the -198 m level. The mining process consists of development drifting, rock drilling for stoping, back-stoping and recovery, transportation, and ore hoisting, in which Meishan has pioneered the introduction of mechanization.

In this respect, the mine has been working hand in hand with Atlas Copco. It installed its first Atlas Copco Simba H252 drill rig in April, 1993, and now operates 11 Atlas Copco rigs. Of these, three Simba H252, one Simba H254

and two Simba H1354 rigs are used for production drilling, while four Boomer 281 and one Rocket Boomer 281 are used in development. In addition, two Scooptram ST1020 loaders are employed on production.

The Simba rigs drill 76 mm blast holes, while the Boomer rigs drill 76 mm cut holes and 48 mm blast holes. All drifting and medium-to-long hole drilling is carried out by Atlas Copco drilling rigs. This equipment has been instrumental in enabling Meishan to continuously improve its productivity and efficiency, year on year.

For example, from 1995 to present, the number of workers employed in drifting has been successively reduced from more than 500 to 160, and the number of miners has also diminished significantly. During the same period, productivity has been substantially increased (see table).

Meishan is in operation approximately 300 days/year, and drifting and mining teams comprise two men per drill rig, six hours/shift, two shifts/day. The Boomer 281 drills for one cycle each shift, with a 3 m advance, while the Simba H252 achieves 120-140 m/shift.

#### Production and equipment build up at Meishan

Year	1999	2000	2001	2002	2003	2004	2005
Development cu m	100,315	109,149	109,536	129,600	115,200	126,770	312,510
Number of drill rigs	4	4	4	5+1 backup	6+1 backup	6+1 backup	5+2 backup
Output of iron ore (Mt)	2.84	3.18	3.33	3.46	3.87	4.00	3.91
Drill metres (x1,000 )	203	248	350	380	375	290	280
Number of employees	1,640	1,540	1,500	1,420	1,460	1,420	1,410

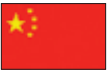

By the end of 2006, annual production for the Simba H252 and Simba H254 was 60,000 m/rig, and the Simba H1354s were producing 72,000 m/rig. The capacity of the Boomer 281 was 1,700 m of drifts, and 1,900 m for the Rocket Boomer 281, in faces 5 m-wide and 3.8 m-high.

## Long partnership

With more Atlas Copco equipment coming on stream, productivity will be successively increased to meet new, ambitious targets for the next phase of development.

According to its plans for Phase Two, mining will proceed down to a level of 420 m, and annual output will be increased to 4.2 million t of ore. The distance between the levels will be also be increased, from 15 to 20 m.

Through its long partnership with Atlas Copco, Meishan has also accumulated extensive experience of equipment management and maintenance, where the focus is on spot checks for cleanliness, lubricating, oil refilling, and greasing. Atlas Copco service engineers provide technical support, assisting on scheduled maintenance and repairs, and spare parts forecasting and stock planning. These combined efforts have led to equipment availability close to 100%.

In addition, as Meishan is a showcase of Atlas Copco's after sales service, training for other customers' operators often takes place at this location.

Excavation equipment managers at the mine state that, during more than 10 years of working with Atlas Copco, they have been consistently provided with equipment of correct design with flexibility in operation, low energy consumption, high reliability, low pollution and long service life.

Excellent after sales service, and an abundant supply of spare parts, can now be taken for granted.

## Acknowledgements

*Atlas Copco is grateful to the directors and management of Meishan Iron Ore Mine for their assistance in the production of this article, and to Baosteel Group Corporation for permission to publish.*



Control panel on Rocket Boomer 281.

Simba H254 (the photo shows another rig than the one at Meishan).





# Breathing fresh life into Otjihase

## Assured future

Namibia, situated on the west coast of southern Africa, has a population of two million. Namibia produces gem quality diamonds, uranium, copper, lead, zinc, arsenic, cadmium, antimony, pyrite, silver, gold, semi-precious stones, industrial minerals and dimension stone.

Weatherly International's operation in Namibia is in an expansion phase. Its mines at Tsumeb West, Kombat, Tschudi, Otjihase, and Matchless were part of Ongopolo Mining and Processing Company, a copper mining and smelting operation, which the company acquired in 1996.

In early 2006, the Otjihase copper mine was facing an uncertain future. Now, with new owners and the introduction of the latest mechanized equipment, the future of the mine is assured.

## Compartmented orebody

Otjihase, situated 40 km from the Namibian capital, Windhoek, employs 375 people, 160 of them underground. It currently produces 35,000 tonnes of ore per month. Its sister mine, Matchless, is located 25 km to the east and together these mines form Weatherly's Central Operation. Some USD 40 million has been earmarked for expansion work during 2008.

The Otjihase orebody is best described as looking like a ruler, divided into five separate compartments by a number of faults. The longest of these extends to 8 km. In plan, the compartments form a line from the surface in the north descending at a shallow angle to the south. In section, the faults have displaced parts of the orebody downward by varying depths. The orebody averages a thickness of 5.5 m to 6 m, and is some 250 m wide, though the more southerly orebodies narrow to a width of about 60 m.

The main 250 m wide orebody has been mined from the surface to an extent of 6 km. The first break in the orebody is the Otjihase fault, which gives it



*Scaletec MC in operation.*

a downthrow of 45 m to the west, from where it continues to the Hoffnung Fault. This has three sections, which give a total downthrow of 190 m. On the southwestern side of the Hoffnung Fault is the Kanuna Compartment, which will

provide the ore for the mine's more immediate future.

The ore contains copper grading at between 1.95% to 2% in the run of mine. The mine also has silver at 7.5 gm/t and gold at about 0.35 gm/t with zinc content

**OTJIHASE MINE**

– Karuma compartment pillar extraction.

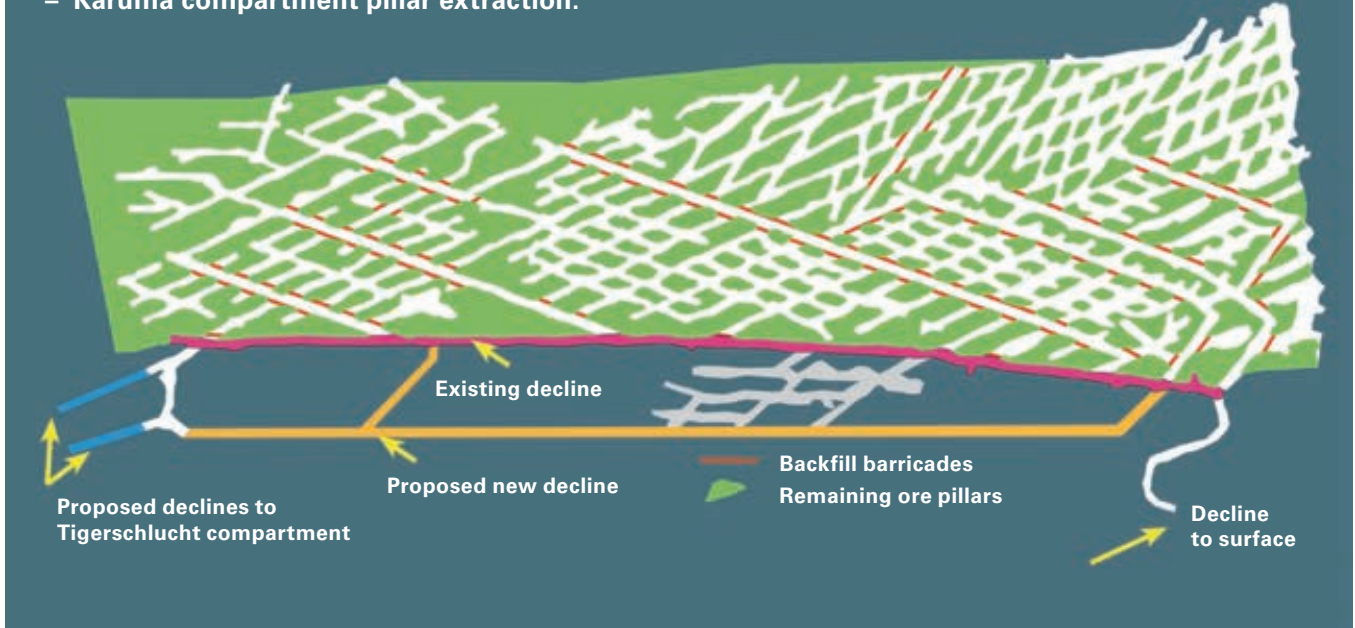

of 0.2%. Currently, copper accounts for 91% of the Central Operation's revenue, while gold delivers 6% and silver the balance of 3%.

Primary crushing is carried out underground, followed by secondary crushing and flotation. The concentrate, containing 24% copper, is trucked to

the smelter at Tsumeb. Recoveries are currently about 92%, with the prospect of 94%, the historical level.

## Grade control

In the Karuma Compartment, backfill plays a key role in pillar extraction. The backfill plant has been extensively refurbished. Fill is pumped underground down two boreholes, and then allowed to gravitate a further 2 km to the compartment.

The orebody dips 16 degrees north-west and plunges 6 degrees to the west. As it is not homogenous, the mineralized zone presents challenges. The greatest variability occurs in a north-south direction. To the north, there are highly folded, magnetite quartzites. Grade control is more difficult in the north than in the central and southern regions, due to the erratic nature of the mineralization.

The northern edge of the orebody is clearly defined, while at the southern edge the ore needs to be sampled to determine the cut-off point. Both the footwall and hangingwall are generally well defined.

Thin, vein-like ore occurrences, or stringers, in the hanging wall make rock support work more difficult, and ventilation and moisture cause the sulphides

*Elize van der Merwe of EPS Mining is Otjihase's Scaletec operator. The machine is really user friendly says Elize, and it is simple to operate. She has been operating the machine for the last two months. Although she had no prior training in operating heavy mining machinery, after a week's training she was sufficiently competent to take over the controls.*





The Cabletec, pictured here at the Otjihase mine, drills, grouts and installs cable bolts.

## THE MINING SEQUENCE

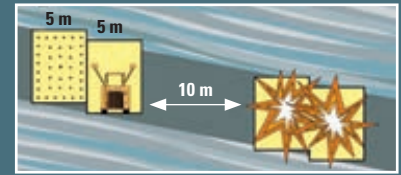

1. To begin, a 5 m panel is broken away and a second, parallel panel is then mined.

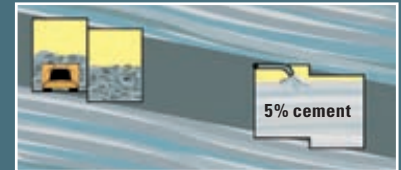

2. After blasting, the rock is mucked out using a Scooptram. Once excavated, the panel is backfilled using a 5% cement mix.



3. The central part of the pillar is recovered, leaving thin walls next to the backfill.



4. The blasted rock is mucked out.



5. The remaining walls are then collapsed and recovered on retreat.



6. Finally, the excavated pillars are filled.



Two new Minetruck MT436B dumptrucks stand ready to be put into service.

to oxidize rapidly, reducing stability. The rock is a quartz-mica schist and the average compressive strength is some 25 Mpa, or 250 bar.

## Contour stoping

The mine uses room and pillar contour stoping where all panels are mined on strike, so that it is possible to cut diagonally across the orebody. To begin stoping, a panel, typically 5 m wide, is broken away followed by a second panel immediately adjacent to the first.

These panels are typically about 100 m long, and take in the full height of the orebody. Between each set of panels, a 10 m pillar is left. This primary phase leaves an approximately-parallel set of rib pillars. The first phase removes some 55% of the orebody, and after the pillar removal phase the final extraction rate rises to between 75% and 85%.

The plan is to extract the remainder of the Karuma Block over the next four years of production. With the Karuma Block in production, Otjihase output will

be 45,000 t/month, which is the maximum that can be extracted in light of the mining complexity.

The mine usually works some 20 faces per day, dropping to 12-14 during pillar extraction, using a six-year-old Atlas Copco Boomer L2 D and a new Boomer 282. Three rigs are needed for peak production, and a second Boomer 282 arrived in March, 2008. The Boomer rigs use 3.7 m rods, giving an average 3.2 m advance per blast.

Work is carried out in three shifts around the clock, and until Saturday afternoon. Blasting is done at the end of each shift with ANFO used for the main holes and various cartridges for the smooth blasting on the perimeter of the pattern.

## Rock scaling

Where sulphide stringers are encountered in the hanging wall, they are blasted out. This increases dilution, but is a small price to pay for the added safety. As a matter of course, roof bolting is

carried out using Atlas Copco Swellex bolts for the consistency of installation.

In the past, for various economic reasons, and also to reach the much needed ore, the Karuma pillars were split, affecting stability in the block. As a result, a number of access ramps contain faults up to 2 m into the hanging wall. The 2.4 m Swellex bolts were not long enough to be effective in these circumstances. The solution lay in mechanized scaling and cable bolting.

An Atlas Copco Scaletec MC equipped with an SB 300 scaling hammer mounted on a BUT SC boom is the mine's choice. The rig is designed for fast, accurate positioning and the hammer has a solid one-piece body without side bolts. A bulldozer-type blade at the front clears the way ahead. The boom can scale at a distance of 8 m from the operator's robust FOPS-approved cab, which tilts by as much as 15 degrees to give the operator a clear line of sight.

The Scaletec features Atlas Copco's computerized Rig Control System, which enhances operating and maintenance





From left, Victor VanWyk, Site Manager, Atlas Copco with Andrew Thomson, General Manager, Otjihase Mine, and Kobus van Tonder, Otjihase's Mining Manager.

efficiency. The rig also has an electrical-ly powered emergency reverse facility. A turbo-charged, four cylinder, low-emission diesel engine allows the machine to tram at 15 km/hr on the flat. While operating, four jacks keep the machine stable. To date, operational availability of the Scaletec has exceeded 96%.

## Cable bolting

A twin-boom Cabletec has been operating at the mine since April, 2007. Having two booms allows the operator to drill support holes with one, while grouting and inserting anchors with the other. A BUT heavy duty boom carries a COP 1838 high performance rock drill with its rod handling system, a combination that offers high-speed drilling and excellent drill rod economy.

Mainly 7.5 m cable holes are drilled with the Cabletec. The penetration rate of 3 m/min means that 22 to 24 cable anchors can be installed each shift. The Cabletec has a really strong positioning

system, so holes can be collared exactly where needed.

Time is saved by drilling support holes while simultaneously inserting and grouting cable anchors. The Rig Control System (RCS) with its interactive operator control panel, gives a full-colour display of the drilling process, cable installation and cement handling systems.

The L-series four-wheel-drive Cabletec carrier is equipped with a Deutz turbo-charged four cylinder low-emission diesel engine. Articulation makes for more manoeuvrability in some of the more confined areas.

Four jacks keep the rig stable during operation and the machine has a FOPS-approved cabin.

The Cabletec has a fully-automatic cement handling unit, which allows for precise make-up of the cement mix. The grout is fed into the hole by a double acting pump.

At the outset of mining the Karuma pillars, it was vital to keep the five ramps running through the orebody open. Zones of instability in the block had caused

various rockfalls. Once the ramps have been made safe, the intervening stopes are barricaded off using mesh and gum poles so they can retain backfill. A primary reason for buying the Cabletec and Scaletec rigs is the facility to start from a safe point to scale the hanging wall. To ensure the continued competence of ramp hanging walls, cable bolting with mesh strips is being installed.

When the secondary slopes have been mined out, the Cabletec will be sent into these areas to install a limited amount of cable anchors. As the pillars are extracted, the hanging wall will subside slowly by about 300 mm as the backfill compresses. Unless this is done, enormous rock stresses will be transferred to the adjacent ground areas.

## Ore handling

To increase the ore handling efficiency, two new Atlas Copco Scooptram ST8B loaders have been bought as well as a third, secondhand unit to bring fleet total to 10 units. These are matched to



An Atlas Copco Scooptram ST2D, more than 20 years old, is still going strong with no apparent oil/hydraulic leaks or excessive emissions at the Otjihase mine.

the dump truck fleet which transports ore from the mine's two working areas to the underground primary crusher. The ore is brought to surface by a system of 10 conveyor belts. The Scooptram ST8B is a relatively simple machine to maintain and has few electronics. This is important in a mine where ultra-fine pyrite dust penetrates tightly-sealed electronic components, affecting their functioning.

The mine also has bought five new Minetruck MT436B dump trucks and now plans to switch the fleet to this 32 t capacity version. These will carry out the demanding job of hauling the ore 1.2 km up the decline from the Karuma

Block, faster and more cost effectively. At the furthest end of the Karuma Block, development will have to traverse the Karuma and River Faults, which have displaced the Tigerschlucht section of the orebody, which is Otjihase's next mining target, some 250 m down to the west.

With access ramps descending at 1:10, it will take 3.6 km of development to reach the new orebody in time to replace the Karuma output. The Scaletec and Cabletec rigs will ensure safe hanging wall conditions during this operation where their first job will be to secure the main access decline running parallel to the Karuma Block, which is currently

unsafe. The decline is important, as it is the only access and transport artery to the Tigerschlucht Compartment, which is geologically very similar to the Karuma orebody. The mine proposes to begin development of the access ramp in the second quarter of 2008.

## Acknowledgements

*Atlas Copco is grateful to the management at Otjihase Mine for their assistance in the production of this article, a version of which first appeared in Atlas Copco Mining & Construction magazine 1-2008.*



# Mechanized mining in low headroom at Waterval

## Boosting production

The Anglo Platinum Group of South Africa, the world's leading platinum producer, has completed an ambitious plan to boost its annual output by 75% from 2.2 million ounces to 3.5 million ounces by the year 2006. This tough target would have been a daunting prospect for most mining companies, especially in conditions at its Waterval mine, where headroom seldom exceeds 2.0 m. However, Anglo Platinum, which accounts for more than half of the total platinum produced in South Africa, has very extensive experience of low seam operations. This experience led the company to Atlas Copco, who supplied a complete equipment package to meet all of its low headroom loading, drilling, and rock bolting needs.

## Thin seam, high output

Waterval Mine is near Rustenburg, about 150 km northwest of Johannesburg. It is one of Anglo Platinum's newest mines, and will be making its contribution to the group's target by excavating 3.2 million t/year in an orebody just 0.6 m-thick and on a decline of nine degrees.

Despite the low seam and restricted mining space, Anglo Platinum was convinced that it could tackle the task successfully, and opted for the room and pillar method with ramp access, together with mechanized equipment.

The mine design meant that the rooms would be extremely confined, with a height of 1.8-2.0 m. This, in turn, meant that headings would have to be as low as possible, and the equipment extremely compact. Anglo Platinum also insisted that quantum improvements be made at the mine in three priority areas: safety, production and productivity, in that order. Potential suppliers were assessed by Waterval engineers. Atlas Copco



*Scooptram ST600LP in the stopes.*

was the only company able to provide a total solution around the three key mining tools required: loader, drill rig, and bolting rig. These needed to be low profile, compact and technically advanced, specially designed for low

seam work and exacting environments. In addition, Atlas Copco agreed to act as a cooperation partner in all aspects of the rock excavation process, providing operator training, spare parts supply, and service and maintenance.

*Room and pillar layout at Waterval where Scooptram ST600LP loaders work in as low as 1.8 m headroom.*

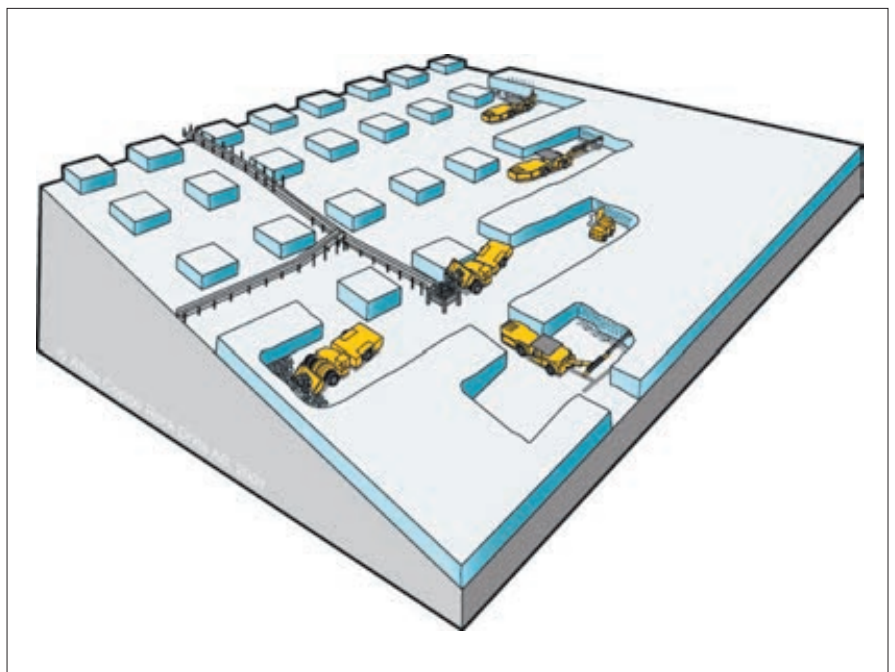



## Purpose matched package

The equipment trio comprised the Atlas Copco Scooptram ST600LP loader, the Rocket Boomer S1 L drill rig, and the Boltec SL bolting rig. The units were progressively delivered to Waterval, until there were 23 Scooptram ST600LP loaders, 15 Rocket Boomer rigs, and six Boltec units at the site.

The Scooptram ST600LP, also known as the Ratel, is a compact LHD with a height of around 1.5 m. It has a 6 t loading capacity, and is equipped with a special bucket for low height work. It is powered by a clean burning 136 kW Deutz diesel engine.

The Rocket Boomer S1 L has well-proven, heavy duty Atlas Copco components such as the COP 1838 rock drill, BUT 28 boom and BMH 2837 feed.

The Boltec SL is a high production, semi-mechanized rock bolting rig with an electrical remote control system. Apart from standard rockbolt installation, it is also equipped to perform long hole drilling for anchor and cable bolting. The Boltec SL uses the same carrier as the Rocket Boomer S1 L, bringing advantages of commonality.

The equipment complement for each mining section is one Rocket Boomer, one Boltec, and two Scooptram ST600LP loaders.

## Production drilling

The layout at Waterval is divided into 12 sections with nine panels, or stopes. Each panel averages 12 m-wide x 1.8 m-high, with pillars of approximately 6 m x 6 m. The drillers work three 8 h shifts per day, six days a week and their target per section is 23,000 t/month. That translates to 200 t per panel, or two panels per shift. Some 68-74 x 3.4 m-long holes are required in each panel, taking around 2.5 h to drill. Three 77 mm holes form the cut, and the main round is drilled using Atlas Copco Secoroc model -27 R32 43-45 mm bits.

Ramps from the surface provide the access for men, machines and supplies, and also accommodate conveyor belts for transporting the ore out of the mine. The mine expects each Rocket Boomer rig to yield around 200,000 t/year. For rockbolting, 1.6 m-long Swellex bolts



Roof bolting in low headroom.

are used, in a standard bolting pattern of 1.5 m x 1.2-1.5 m. The Boltec SL is equipped with Secoroc Magnum SR28 Tapered Speedrods, with 38 mm model -27-67 bits for Swellex installation. The tramming height of the Boltec SL is just 1.30 m, with ground clearance of 0.26 m. It is equipped with a COP 1028HB rock drill, and can insert a Swellex bolt of length up to 1.6 m in roof height of 1.8 m.

With so many available faces in close proximity to each other in the room and pillar layout, utilization is a key factor for maintaining a high level of productivity and efficiency. The required utilization for the drill rigs ranges from 50%-75%, and availability is about 90%.

## Low height loading

The Scooptram ST600LP is an extremely robust loader designed specifically for demanding thin seam applications where the roof heights are as low as 1.6 m. For visibility on the far side of the machine, video cameras point to front and rear, displaying the views on a screen in the driver's cab. Loading from the different rooms is a crucial part of the operation, and the specially designed E-O-D (Eject-O-Dump) 6 t-capacity

bucket on the Scooptram ST600LP makes low height work easy. Using the E-O-D bucket, the rock is pushed out by a push plate onto feeders that transfer it to the conveyor system for transportation to the surface. The Scooptram loaders are refuelled underground and generally drive up to the surface for maintenance.

At Waterval, Anglo Platinum gives top priority to dilution and utilization. The amount of rock waste must be kept to an absolute minimum, and the fact that this can be achieved with mechanized equipment in such a low, flat seam is seen as a major achievement.

To ensure high availability of the equipment, Anglo Platinum and Atlas Copco have entered into full-service contracts that provide for 24 h service and maintenance. It makes good business sense for the mine to have a service contract manned by specialists with the technical know-how and skills for optimal maintenance.

## Acknowledgements

*Atlas Copco is grateful to the management at Waterval for their kind assistance in revision of this article and for permission to publish.*



# Large scale copper mining adapted to lower seams

## Efficient commercialization

Copper mining began in the 13th century in the Sudety Mountains. However, intensive exploratory works beginning at the middle of the 20th century confirmed a copper ore-bearing deposit 1,000 m below surface with over 0.5% Cu content. The first mines, called the Old Basin, are now closed and replaced by mining of the New Basin, known as Legnicko-Glogowski Okreg Miedzowy, LGOM, situated in the south-west region of Poland. It is based on three big mines with various dates of construction start: ZG Lubin (since 1960), ZG Rudna (since 1970) and ZG Polkowice-Sieroszowice (since 1996). The latter mine results from joining of the former single mines: ZG Polkowice (since 1962) and ZG Sieroszowice (since 1974). All mines belong to a joint-stock company, KGHM Polska Miedz S.A., with head office in Lubin, and comprising ten divisions including three dressing plants, two smelters and one copper rolling mill. In the ten years between 1991 and 2001, when commercialization of the former state owned company was undertaken, the company workforce reduced from 45,000 to about 18,500. About 11,500 employees are engaged in the mining operations.

## Geology and resources

The Legnica-Glogow copper basin extends over an area of 416 sq km. The stratiform mineralization occurs where Permian limestone lies against New Red Sandstone, within varying combinations of sandstone, shale and dolomite. The deposit is of irregular shape, with slight dip up to about 6 degrees. The copper content varies generally between 1.2% and 2.0%. Higher copper contents are characteristic for the thinnest seams, usually in mineralized shales.



One of four Scooptram ST1520LP loaders owned by KGHM in operation.

In the Lubin mine the average copper content is less than 2%, whereas in the Polkowice-Sieroszowice mine, the mean copper content slightly exceeds 2%. The average copper content for all KGHM mines is around 1.86%. The ore horizon ranges from 1.2 m to 20 m in thickness, lying at depths of between 600 m and 1,200 m from surface. Known ore reserves are above 800 Mt, which corresponds to a mine life of another 30 years at today's production rate of 28 Mt annually, split between Lubin 7Mt, Polkowice-Sieroszowice 10Mt, and Rudna 11Mt.

Lead, silver and gold are also recovered. In 2001 KGHM was ranked as the world's seventh largest copper supplier at 491,000 t, and the second largest source of silver, at 1,145 t.

KGHM is also a major salt producer, using roadheaders to mine a deposit that partly overlays the orebody.

## Geotechnical conditions

The formations are intersected by a multitude of faults. An especially dangerous feature of the rock is its ability

to accumulate high amounts of energy, which is the most important factor for rock burst. Even within a strong roof, in some places weak layers of shales essentially decrease the roof bearing capacity. This is the main reason for extensive rock reinforcement, comprising standard mechanical and resin grouted 1.6 m and 2.6 m bolts, and 5-7 m cable bolting, mainly at drift crossings.

## Ore access and transport

The deposit is developed with 26 vertical shafts, 6 m to 7.5 m-diameter, and horizontal drifts. Depths of shafts vary from 632 m in Lubin to 1,120 m in Rudna. The overburden freezing method was applied for shaft sinking. Access to the deposit from the shafts and preparatory workings is by drift networks located directly under the strong dolomite roof and upon the sandstone, along the dip of the ore zone.

Mucking is based on a large fleet of LHDs ranging from 1.5 to over 8 cu m bucket capacity. Belt conveyors are used for main haulage. Equipment used in the shafts varies, and depends on the

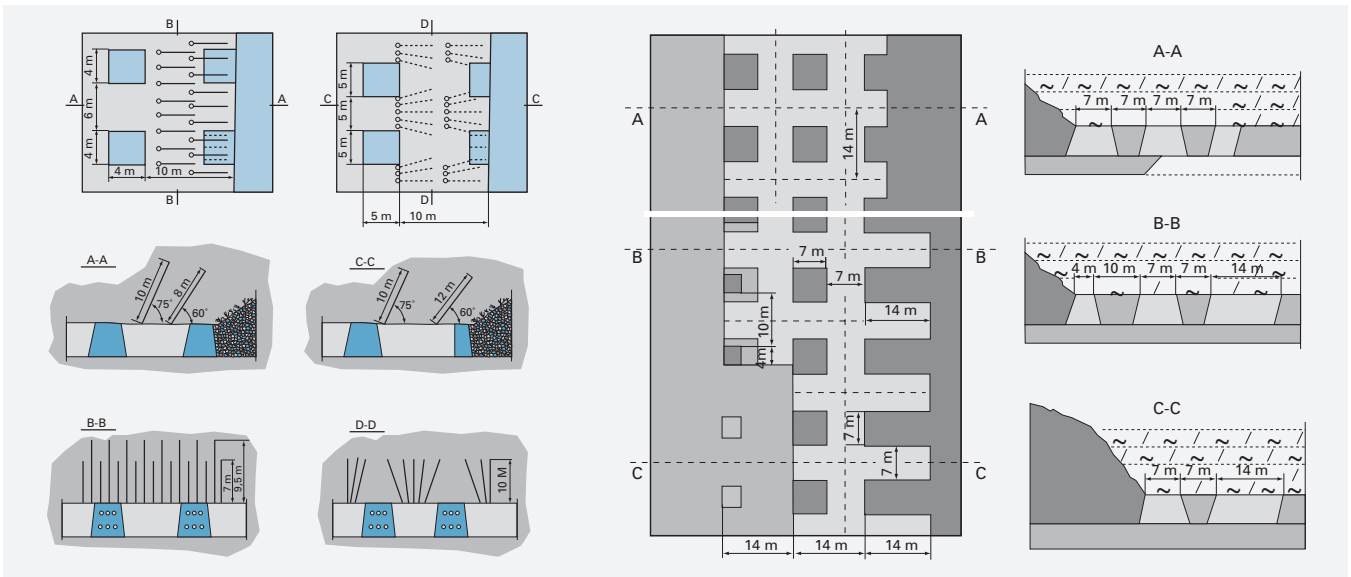

System for mining thick deposits.

purpose of the shaft. The most modern shaft in Rudna mine is Koepe hoist equipped with two twin-skip hoisting installations. Each of the skips has 300 kN capacity and 20 m/s transportation velocity. The depth of the loading level is 1,022 m. Each skip is powered by a four-line hoisting machine with 5.5 m-diameter transmission using 3,600 kW motors.

## Room and pillar

The predominant method is room and pillar mining adapted to seam thickness and geotechnical conditions.

### Deposits up to 5 m-thick

After shaft sinking and recognition of the water threat, the initial mining method utilized backfilling technology. Following this, longwall methods using walking hydraulic supports, armoured face conveyors and belt conveyors were introduced. Very soon, after experiencing low efficiency, it was decided to use room and pillar methods with bolting techniques, and LHDs that could assure mass production and better output concentration. With time, and production experience, room and pillar methods with roof caving have become more effective and safer, since they enabled full mechanization to be introduced. The caving methods were more competitive, due to low costs compared to backfilling techniques. Initially, for

the exploitation of roof caving, two stages of excavating pillars were used. In the first stage, the area was divided into 25 m x 35 m pillars. In the second stage,

each of the pillars, beginning from the abandoned line, was cut into many smaller pillars. From the viewpoint of rockburst risk, the two-stage method is

General mining layout for 3 m thickness at Polkowice-Sieroszowice Mine.

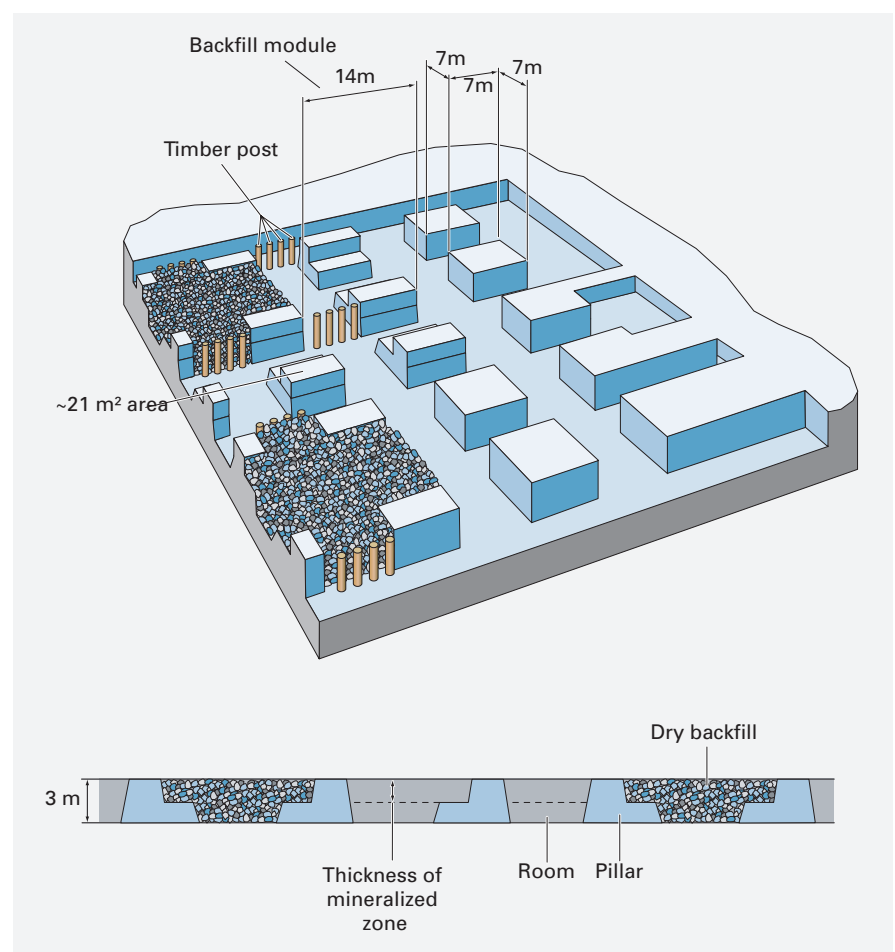



tricky, because the pillars in the first stage show a dangerous tendency for accumulation of energy. After 1983, the engineers in Rudna mine decided to adapt the dimension of the pillars to local geomechanical conditions. Also, alternating directions of driving stopes were introduced.

### Deposits 5 to 7 m-thick

Until recently, the deposits over 5 m-thick used to be mined entirely with backfilling. The newest technology to 7 m-thick is based on the hypothesis of advance-fracturing and post-failure capacity of pillars. The roof opening reaches 150 m, and the longest edges of the pillars are located perpendicular to the exploitation front line.

Within caved areas, the upper layers of roof are not fully supported with broken rock. Such a situation creates real threat of rock bursts, roof falls, or local relief of strata. This results in ore dilution, as well as a requirement for secondary scaling and bolting. Therefore, the practice of blasting residual large-size barrier pillars has been abandoned.

### Deposits below 3 m-thick

In the Polkowice-Sieroszowice mine, most of the seams are less than 3 m thick, and a special selective mining method has been developed for excavation of these thin deposits.

The mining area is typically opened using double or triple entries of preparatory workings. Rooms, entries and pillars are basically 7 m-wide. Work in the faces consists of two phases, depending upon the thickness of the layers of waste rock and mineralized ore. First, the upper ore-bearing layer is excavated and hauled out to special chutes onto the main transportation system. In the second phase, the waste rock adjacent to the floor is excavated and placed in other rooms as dry fill. Each of the entries covers at least two rows of pillars plus one room.

The backfill width is 14 m, and maximum length of the mining front is about 49 m. No more than three rows of pillars at the same time, not covered with backfill, are allowable in the mining area. During extraction in the last row of pillars, working occurs only

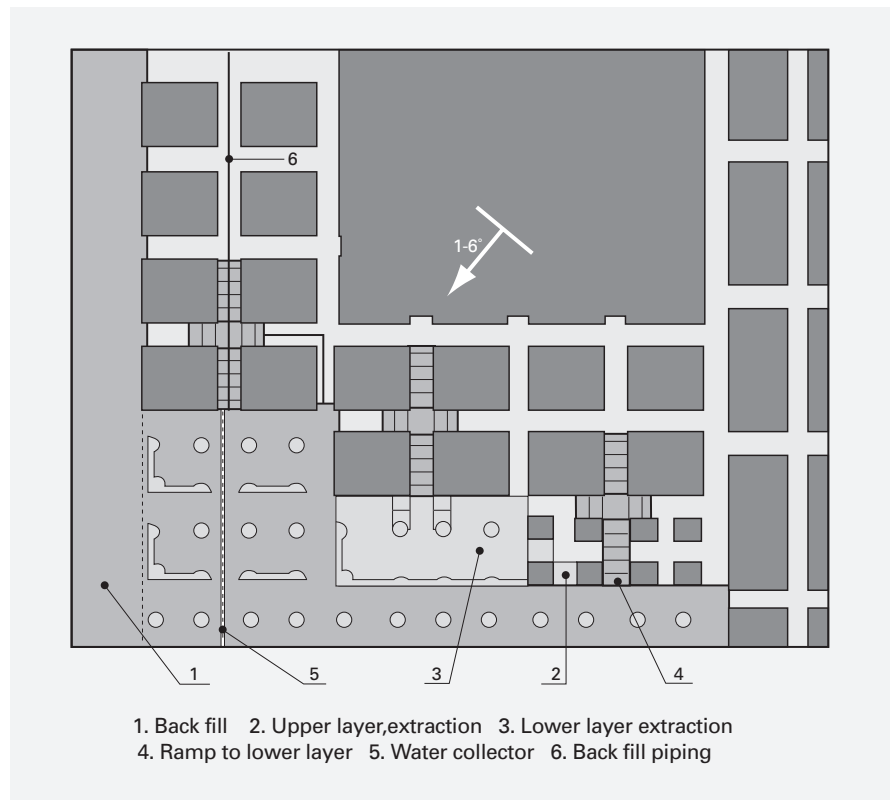

*Two-stage extraction with backfilling.*

in the ore-bearing layer until the pillar cross-section reaches approximately 21 sq m. The completion of the pillar mining process before abandoning the area is subject to roof sag, with the strata resting upon dry backfilled entries.

The future aim is to use extra low profile mechanized equipment for drilling, bolting, mucking, scaling, charging and auxiliary transport. This will enable mining in drift heights down to 2 m and 1.5 m, to selectively extract the ore and minimize the amount of waste rock mined.

Alternative mining sequences, where the ore-bearing layer is situated at the floor, are shown in the figure.

In the past, most equipment and consumables were manufactured in nearby factories belonging to the state-owned company. Lately, the quantities and types of imported equipment have gradually increased. In 1998, Polkowice-Sieroszowice Mining Department started to cooperate with Atlas Copco in the development of modern machinery. Due to the successful introduction of COP 1238 and COP 1838 hydraulic rock drills, followed by the low-built Boomer rigs, the cooperation has been

strengthened. The mine currently operates ten Atlas Copco rigs, and there is a total of 16 Boomer rigs on the mines as a whole.

The supplier service has been extended to include a drillmetre-based contract for Secoroc Magnum 35 drill rods and shank adapters and for COP rock drills.

Working an effective 4.5 h/shift, one Boomer drills 110-125 holes with hole lengths varying from 3 m at the face and 1.5-2 m at side walls and roofs. Some of the Boomers feature the BSH 110 rod extension system to facilitate drilling of 6 m stress-relieving holes.

In the first 8 months of 2002, one Boomer drilled more than 58,000 holes totalling 174,000 drill metres, with availability of 92.6 %. Downtime comprised technical malfunctions 3.7%, planned service 3.4%, and others 0.3%.

### Room and pillar mining with roof sag

This method is especially suitable in barrier pillars of drifts, heavily faulted zones, and in direct vicinity of abandoned areas. Maximum allowable deposit dip is up to 8 degrees, and seam thickness 3.5-7 m. The area is developed

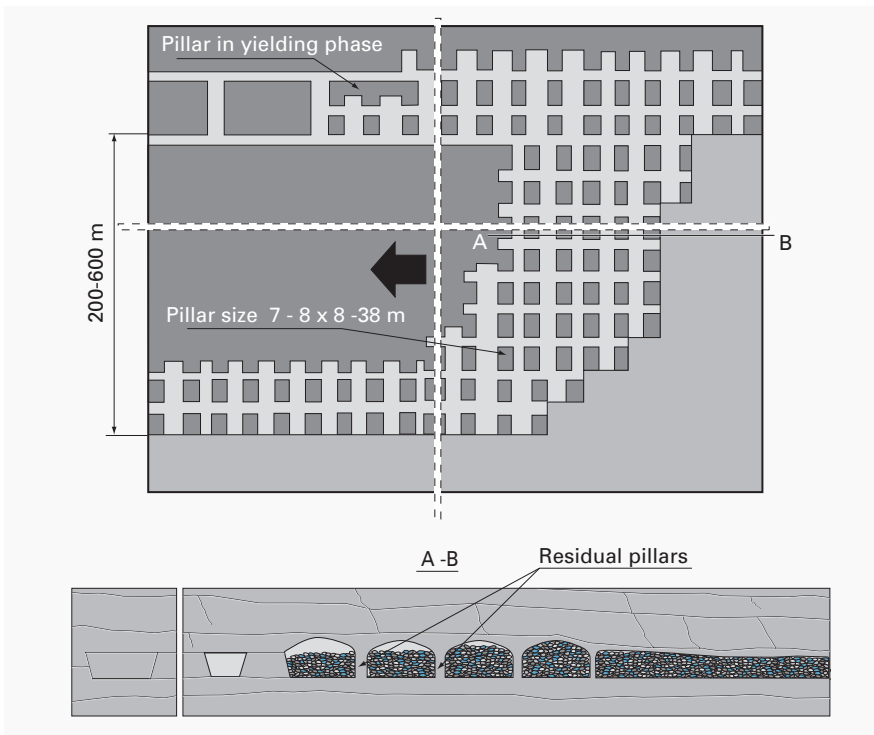

Room and pillar mining with roof sag.

with double gate roads, located close to the roof of the ore-bearing layer for thickness above 4.5 m. Optimum length of the mining front ranges from 50 m to 600 m. The ore is extracted with 7 m-wide and 7 m-high rooms. The roof is supported by pillars of 7-10 m x 2.5-4.5 m. Thereafter, the smaller pillars are successively decreased. The roof that has been opened must be bolted immediately.

The next stage is mining of the floor down to the ore zone boundary. The extracted area is closed off for people and equipment, using timber posts or chocks. Length of the roof sag blast holes is 8-12 m.

### Room and pillar mining –two stage mining

The two stage mining system using hydraulic backfill known as Rudna 1 has been used mainly in the Rudna mine. In the first stage, the orebody is cut into large pillars, which are subdivided in the second stage.

Finally, the abandoned area is filled up to the roof with hydraulic fill. The drawback of this system is high stress concentration occurring in the large size pillars just in front of the second stage mining.

### Blasting techniques

In the past, the mines tried to use dynamite, which is a water-resistant explosive of high density and energy concentration. Due to the sensitivity to detonation, and lack of possibility for mechanical charging, dynamite is today almost completely superseded by pneumatically charged ANFO. Initiation is by electric delay detonators, coupled with detonating cord in holes longer than 6 m. Recently, electric detonators have been successively replaced by Nonel. Bulk and emulsion explosives are used in room and pillar mining areas described in the hydraulic backfill method above.

### Future plans

The alternative room and pillar mining methods described are some examples

from a large variety of adaptations to prevailing geological and geotechnical conditions, in order to continuously increase productivity and safety, while minimizing waste rock into the ore stream. The following measures are put into focus for the future: further development of the rock mass monitoring stream; changes in work organization and introduction of a four-team system; developing new systems for rockburst-proof bolts; introduction of low built equipment for thin ore deposits, lower than 1.5 to 2 m; modernization of mining methods by further minimizing waste dilution; and projects for access to deeper ore zones, below 1,200 m, by cake mining, with cake thickness of 0.8 to 1.5 m, using 15 m-long blast holes.

All mines are facing thinner seams, and this constitutes a major challenge for equipment manufacturers. The problem is especially acute at Polkowice-Sieroszowice, where machinery height since 2003 on all types of equipment cannot exceed 1.4 m, to enable efficient operations in 1.6 m-high workings. To this end, a special low-built version of the latest Atlas Copco Rocket Boomer S1 LP has been delivered for testing and evaluation.

### Acknowledgements

*Atlas Copco is grateful to KGHM management for their inputs to this article, and in particular to the authors of its book on the technical evolution of the Polish copper mining industry:*

*Jan Butra, Jerzy Kicki, Michal Narcyz Kunysz, Kazimierz Mrozek, Eugeniusz J Sobczyk, Jacek Jarosz, and Piotr Saluga. Reference is also made to Underground Mining Methods – Engineering Fundamentals and International Case Studies by William A Hustrulid and Richard L Bullock, published by SME, details at [www.smenet.org](http://www.smenet.org)*

Atlas Copco drill rigs and loaders delivered to KGHM	
Type	Units
Boomer S1 L	5
Rocket Boomer S1 L	26
Rocket Boomer 281 SL	4
Scooptram ST1520	6
Scooptram ST1520LP	4



# Underground mining of limestone and gypsum

## Trading costs for profit makes mining more attractive

Limestone in its various forms is in such great demand, both as high quality roadstone and as the raw material for cement and steel manufacture, that its mining is frequently carried out underground. Gypsum is needed as an additive to the cement-making process, and is also a major input to building plaster and plasterboard production.

Closeness to the market, or availability of a suitable mineral deposit, may be the driver, but economic extraction is the deciding factor. In essence, the underground limestone and gypsum mines are trading off the savings in surface transportation costs by being closer to the point of use, against the marginal difference in production costs between surface and underground working.

Where these are approximately in balance, an underground mine can be profitable, as the following examples show. In all cases, Atlas Copco drill rigs are the key to economic success.

## Case studies

The major characteristic of a successful underground mining operation is its efficiency, and the single greatest factor affecting this is the cost of drilling and blasting. Atlas Copco drill rigs are bringing down this cost by a combination of drilling speed and accuracy with low maintenance and longevity. Matching the drill rig to the job ensures that, whatever the mining situation, economic long-term production can be achieved, sometimes with the whole operation dependent upon a single machine. The following case studies from four very different locations serve to underline this point.



*Rocket Boomer L1 C-DH drilling the face at Auersmacher limestone mine.*

## Auersmacher, Saarland, Germany

Since 1936, almost 20 million t of limestone have been produced at Auersmacher, a border town in Saarland, Germany. The mining area covers almost 4 sq km, with overburden of approximately 50 m in thickness and an average mining height of some 6 m. The Triassic strata comprises a shelly limestone, which is excellently suited as an aggregate for the local steel industry.

The mine is working a room and pillar system of extraction in the horizontal deposit, and the normal face is 5 m-high and 6.5 m-wide. The length of a room plus pillar is about 100 m, in which some limestone is left to form the permanent roof.

A diesel-powered computerized Atlas Copco Rocket Boomer L1 C-DH hydraulic drill rig is used because there is no electricity supply installed to the faces. It is equipped with a COP 1838 rock drill with 22 kW output. As a result, blast holes of 51 mm diameter can be drilled to depths of 3.4 m at a rate

of 6-8 m/min. Each V-cut round of 35 holes produces up to 340 t, and takes only an hour to drill.

The Rocket Boomer L1 C-DH rig drills the entire daily production output in a single shift, returning very favourable operating and wear costs. Mine output is currently 350,000 t/year, for which the rig is drilling six rounds on each dayshift. The rest of the mine works two 8 h shifts/day, 5 days/week on production, with a Saturday morning shift for non-production work if required.

Experience with the diesel hydraulic unit has shown it to be economic on fuel, and to exhibit low exhaust gas emissions.

The Rocket Boomer L1 C-DH diesel engine consumes only about 19 litres of diesel for each percussion drilling hour, and can complete two shifts on a single tank of fuel. The excellent exhaust emission values are very important in underground mining, where ventilation can be costly. Due to the very good drilling and flushing characteristics using water mist, drill rod losses are negligible. Water consumption varies



View from the driver's seat of the Rocket Boomer L1 C-DH.

from 2-5 lit/min depending upon rock conditions, and a full tank lasts a week. The water mist mix is adjusted by the operator. With too little water, it is impossible to drill, and with too much, the cuttings become slurred.

The rotation speed has a profound effect on penetration rate. In the limestone rock at Auersmacher, the optimum speed is 400 rev/min. Dropping it to 300 rev/min reduces the penetration rate by 2 m/min.

Drilling is carried out exclusively with Atlas Copco shank adapters and drill rods, and the very good dampening and anti-wear properties have resulted in enormously long service lives, despite the high work capacity. For example, the approximate service life of drill bits is 3,200 m, rods 10,000 m, and shank adapters, 18,500 m.

Secoroc shank adapters and steels are used with 51mm ballistic bits. A couple of years ago the mine switched

Rocket Boomer L1 C drilling 4.5 m-long blastholes at Obrigheim.



from 42mm bits, achieving a 2 m/min improvement in penetration rate, with accompanying gains in ANFO blast yield.

At the start of each drilling shift the operator takes around 15 minutes to check the engine oil, feed hoses and grease points. His training as a mechanic helps him to get the best out of the sophisticated engine. The servicing requirements have no negative impact on mine production.

High temperature greasing of the rock drill gearbox is carried out every 40 hours, or once a week.

The close support of the Atlas Copco team has resulted in a collaborative relationship that gets the best out of the equipment.

## Obrigheim, Neckarzimmern, Germany

Heidelberg Cement employs some 37,000 people at 1,500 sites in 50 countries, a truly international company with sales in excess of EUR6.6 billion.

Since 1905, the company has been operating an underground mine in Obrigheim producing gypsum and anhydrite. This operation is only possible thanks to the use of percussion drilling technology provided by an Atlas Copco computerized Rocket Boomer L1C drill rig introduced in 2003. Training for operators covering drilling, systems and maintenance was provided by Atlas Copco, leading to excellent results and high utilization.

Production is by room and pillar, with 10 m-wide x 5.5 m-high drives. A 4.5 m-deep round comprises four cut-holes of 89 mm-diameter and 60 blast-holes of 45 mm-diameter. Much work has been put in by both the mine and Atlas Copco to optimize the drill pattern to maximize the pull of each round.

The rig is equipped with a heavy duty COP 1838HF rock drill, and hydraulic systems and onboard compressor are driven by a 75 kW electric motor. The diesel engine is used to move the rig around the mine. A water tank with water admixture device provides the flushing medium for drilling.

Penetration rates vary considerably due to the large range of compressive strengths of gypsum and anhydrite,



which are spread over 10-130 Mpa. A 45 mm-diameter hole, 4.5 m-long is drilled in 40-75 seconds. The computerized drilling log has recorded an average penetration rate of 3.23 m/min, including cut holes.

Of the 300,000 t/y mine output, some 90% goes to the cement industry, with the remainder used by the Neckarzimmern gypsum plant for plaster manufacture.

## Josefstollen, Trier, Germany

Josefstollen mine was opened in 1964 and produces some 600,000 t/y of raw dolomite primarily for the building materials industry. Operating company TKDZ has some 40 million t of reserves at its disposal, enough for another 40 years of mining.

The dolomite is of excellent quality, with a compressive strength of 130-150 Mpa, and optimized underground production allows the products to be placed on the market at competitive prices.

Mining is by conventional room and pillar at two gallery levels in the bottom and central beds. The production area is initially opened up by mining horizontal galleries, with ramp access to the individual beds. Room widths are 5 m in the bottom bed and 5.5 m in the central bed, with heights of 5.0-5.5 m.

Each blasting round comprises 29 off 3.3 m-deep x 45 mm-diameter holes with a Vee cut. Around 13 faces/day must be drilled to keep pace with demand.

Drilling is carried out by a diesel-hydraulic Rocket Boomer L1 C-DH rig equipped with COP 1838HF rock drill and air-water mist flushing. The rock drill takes around 25-30 seconds to drill each hole, at a penetration rate of 8 m/min. Total drilling time is about 30 minutes for each round.

The dolomite is difficult to drill because it is not a continuously compact formation, so the computerization on the drill rig, which controls both the hammer and feed, plays a vital role. As a result, most of the required drilling is completed on a single shift, with the second shift offering flexibility for drilling awkward places and for performing maintenance. The mine also sees this



*Rocket Boomer L1 C-DH with COP 1838HF rock drill achieves 8 m/min at Josefstollen.*

slack time as a reserve against any increased production demand.

## Yongjeung, Jechon, Korea

Yongjeung limestone mine is situated in Jechon city in the Choongbook province of South Korea, some 150 km southeast of capital city Seoul.

The strata is a middle limestone member of the Gabsan formation in the upper palaeozoic Pyeongan super group of minerals. The geological structures are mainly controlled by a NW-SE trending, with westerly overturned folds and thrust faults.

Reserves confirmed by drilling are over 12 million t, of which it is expected

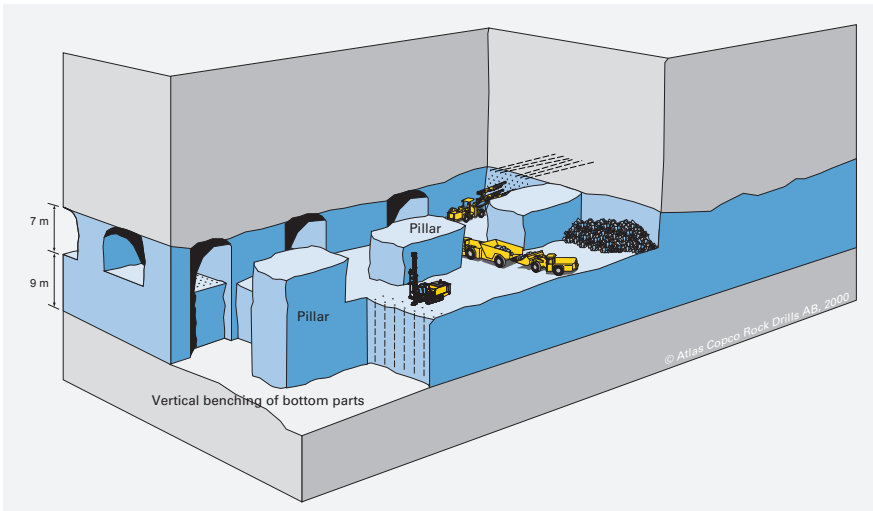

Principle mining method at Yongjeung.

that over 5.5 million t will eventually be mined. Average chemical analysis of the limestone bed is CaO 54.4%, SiO<sub>2</sub> 0.78%, MgO 0.53%, Al<sub>2</sub>O<sub>3</sub> 0.03%, and Fe<sub>2</sub>O<sub>3</sub> 0.17%.

Around 25,000 t/month of limestone is produced for markets that include companies operating plants for the manufacture of desulphurization products, quicklime, calcium carbonate and chicken feed.

The limestone bed is mined in three steps, starting with 15 m-wide x 7 m-high room and pillar, followed by a 9 m bench. A Rocket Boomer L1 C-DH diesel powered drill rig is the main production machine in the room and pillar faces,

drilling 4 m-long x 51 mm-diameter holes. Generally, 50 holes are drilled in each face, and three faces are drilled in each 8 h shift. This affords a capacity of 3,000 t/day or 70,000 t/month. When drilling, the rig's diesel engine operates for around 1 min/drilled metre, consuming 0.31 litres of fuel. Returns from rig consumables are: rods 975 m; bits 750 m; shanks 3,900 m; and sleeves 1,950 m.

An Atlas Copco ROC D5 crawler rig is used for downhole drilling of the bottom bench. This rig has a long folding boom which allows the operators to drill at a comfortable 5.5 m from the edge of the crater, a major improvement

Rocket Boomer L1 C-DH on demonstration at Yongjeung limestone mine.



over the previous pneumatic rigs, which needed to be within 2 m of the edge.

## Conclusions

Where there is no suitable electricity supply to the mining areas to power an electro-hydraulic rig, as at Auersmacher and Yongjeung, diesel-driven hydraulic rigs offer a means of upgrading mining efficiency without excessive capital expenditure. At these mines, drilling rates doubled with the introduction of the Rocket Boomer L1 C-DH, and round depths increased significantly. These machines, equipped with water tanks and water mist flushing, operate efficiently despite the absence of mains supplies of water and electricity. They are also adaptable, performing on both production and development, and handling rockbolt and ancillary drilling.

Production and efficiency gains have been recorded wherever the Rocket Boomer L1 C-DH has been introduced, making it a boon to mines where every penny counts.

## Acknowledgements

*Atlas Copco is grateful to the managements at Auersmacher, Heidelberg, TKDZ and Yongjeung for their inputs to this article and for permission to publish.*

Atlas Copco ROC D5 drilling the bench at Yongjeung.





# Sublevel caving for chromite

## In search of excellence

Cia de Ferro Ligas da Bahia (Ferbasa) is a private capital group, which produces chromite, silicon and limestone. One of Brazil's most important metallurgical companies, Ferbasa has surface and underground mining operations in the state of Bahia in north-eastern Brazil, where their Pedrinhas open pit chrome mine, located in Campo Formoso, has been in operation since 1961. Pedrinhas currently produces about 2,400,000 cu m/year of chromite ore and waste, yielding 54,000 t/year of hard lump chromite and 114,000 t/year of chromite concentrate. At the Medrado and Ipueira underground mines, lump chromite is produced using primarily sublevel caving techniques with raises opened using slot drilling, where a fleet of Atlas Copco equipment offers key support in exploration, development and production.



Entrance to the Ipueira mine.

## Underground geology

Located in the city of Andorinha, around 100 km from the Pedrinhas mine, the company's underground operations have been developed within the Medrado/Ipueira deposit.

This is one of several chromite-mineralized intrusions in the Jacurici Valley in the north-east of the São Francisco Craton, which hosts Brazil's largest chromite deposits. Being irregular and fractured with numerous faults, the deposit presents a considerable geological and mining challenge.

The Medrado/Ipueira deposit is divided into several mining areas. There are the Medrado mine and the Ipueira mine, the latter of which is divided into five working areas: Ipueira II, III, IV, V and VI. Currently, besides Medrado, only Ipueira II, III, IV and V are operational, whereas Ipueira VI is a future expansion project. The underground mines have been in steady operation since 1977. In 2004, Ipueira produced 450,000 t

of run-of-mine ore for a final production of 127,000 t of hard lump. In the same year Medrado produced 192,000 t of ROM ore for a final production of 48,000 t of hard lump. Current target is a total of 216,000 t of hard lump.

## Underground exploration

The company is always looking for the best way of doing things in consultation with workers, technical consultants and through visits to other mines. The consultation process also includes manufacturers of mining equipment, with which Ferbasa discusses the best technological options for its operations. This consultation process is very important for the mine, in order to help maintain a high level of modernization.

From a geological point of view, the Medrado/Ipueira orebody represents a challenge. With an average thickness of 8 m, and 500 m-long panels, the orebody is irregular and fractured with numerous faults. The accurate delineation of the orebody is very important, and to this end the geology department has to carry out a great deal of exploration drilling. The main machine employed in this key task is an Atlas Copco Diamec U6 exploration drill rig equipped with

an operator's panel. This machine is used in all situations at the underground mine, to drill holes of up to 150 m-deep. The decision to acquire this machine took into account the fact that it is equipped with a wire line system. This feature makes possible to conduct core drilling in the worst rock conditions, such as the faulted and fractured rock at Ferbasa.

Ferbasa carries out about 7,200 m/y of drift development. The fleet of development rigs includes two Atlas Copco electro-hydraulic units. One is a Rocket Boomer H 252 rig equipped with COP 1238 rock drill which drills 3.9 m-long holes to achieve 6,000 drilled metres/month at a productivity of 55 m/hour. There is also a Rocket Boomer M2 D rig equipped with COP 1838ME rock drill which drills 4.5 m holes to achieve 12,000 drilled metres/month at an average rate of 70 m/hour.

## Sublevel caving

The main underground mining method employed is longitudinal sublevel caving, though open stoping is also used in some areas of Ipueira, depending on the layout of the orebody. When the orebody is vertical, sublevel caving is used

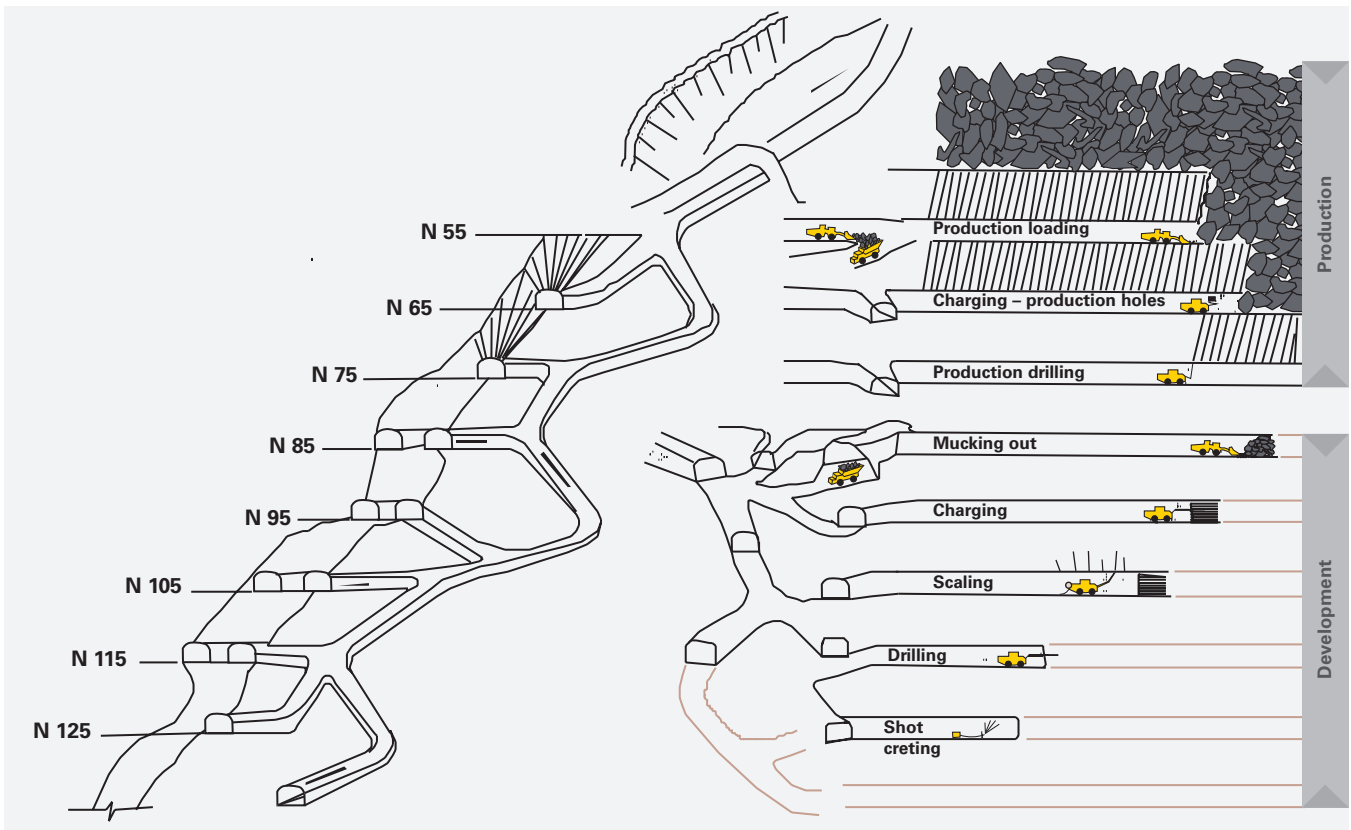

Layout of Ipueira mine.

and, in the few cases when the orebody is horizontal, open stoping is the preferred method. Both methods are safe, with currently acceptable dilutions. However, the management has started looking for suitable alternative methods that will reduce the dilution in future. For longitudinal sublevel caving, production drifts are developed in the footwall

of the orebody. The vertical distance between sublevels varies from 14 m to 30 m. Production drilling is upwards, using a fan pattern. The broken ore is loaded using LHDs, and is hauled from the production levels to the surface using rigid frame trucks.

In terms of production, the company drills 180,000 m/year of production

blast holes, which have a diameter of 51 mm and a burden of 2.2 m. At the same time, they are studying the possibility of changing to 76 mm-diameter holes and 2.8 m burden, in order to reduce costs.

The fleet of production drill rigs includes an Atlas Copco Simba H254 and a Simba 253, both electro-hydraulic

The locations of drifts and drill patterns are adapted to the ore-waste boundaries.

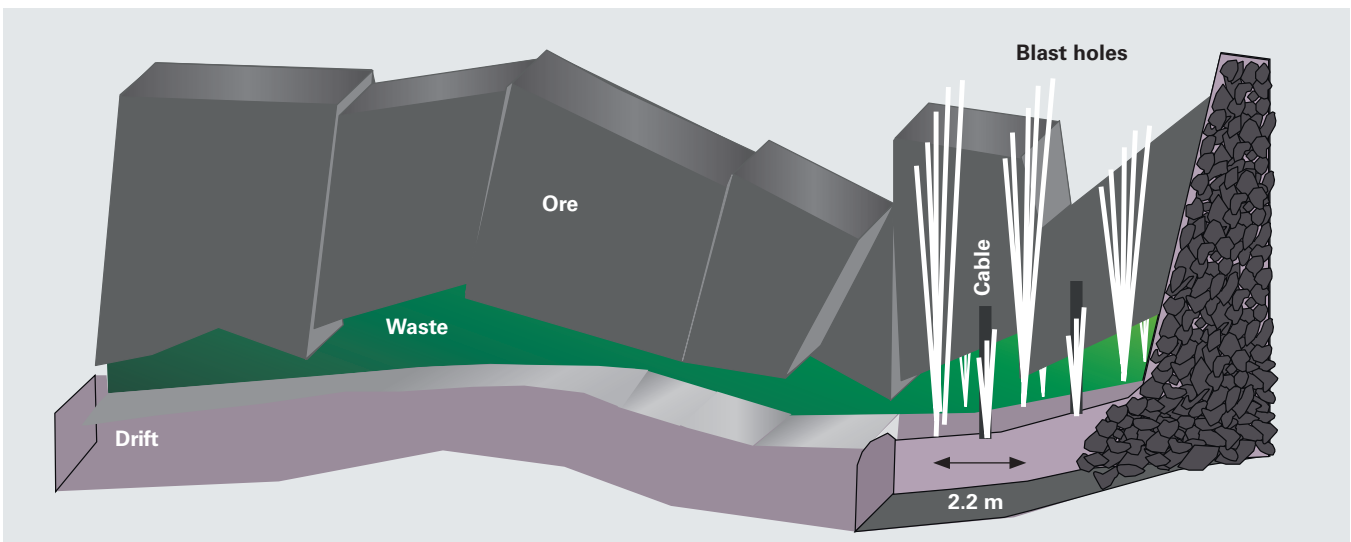



Slot drilling at Ferbasa: The Simba M6 C in action and, (right), the perfectly finished row of holes.

rigs equipped with COP 1238ME rock drills, which drill 6,000 m/month to achieve a productivity of 22 m/h. The mine also has a Promec M195 pneumatic rig equipped with COP 131EL rock drill. These machines are also used to drill orebody definition holes, and achieve 3,500 m/month.

## Slot drilling

One of the main challenges at Ferbasa's underground operations is the development of inverse drop raises. These openings, which are also called 'blind raises' because they don't communicate with the upper level, can only be accessed from the lower level. This limitation is dictated by the mining methods.

Previously these blind raises were developed upwards by successive individual

advances of up to 6 m. Nowadays, this practice has been replaced with a fully mechanized method, increasing the speed and safety of drilling the openings. Looking for a solution to improve operator safety when drilling these production raises, technical personnel from Ferbasa visited LKAB's Malmberget iron ore mine in Sweden, where they studied the development of inverse drop raises blasted in one single shot. After the visit, Ferbasa started employing a slot drilling technique, and Ipueira and Medrado are now the most experienced mines in Brazil in its use. Slot drilling requires a row of 7.5 in -diameter interconnected holes to be drilled using a special guide mounted on a regular ITH drill hammer. Thus, with an available free face, drilling accuracy, and controlled blasting techniques, openings

of up to 25 m length are successfully achieved. The main advantages of the method are personnel safety and speed in the drilling. Also, slot drilling is more precise and, in general, more productive.

A Simba M6 C drill rig equipped with COP 64 DTH hammer and ABC Regular system, as well as an on-board booster compressor, has been acquired for drilling inverse drop raises with holes up to 10 in-diameter. Depending on the length of the raise, and the quality of the rock mass, the slot drilling technique is used. If the length of the raise is short, and the rock quality poor, the traditional technique with reamed holes is used.

Until the Simba M6 C arrived, Ferbasa was carrying out slot drilling with only one machine. They chose the new Simba rig because of its advanced technological and safety features. One of the main advantages is the setup, which only has to be carried out once at each site.

The Simba M6 C machine is also easy to operate, and the spacious, air-conditioned cabin is an attractive feature.

The mine spent five years looking for a solution to the opening of inverse drop raises, and is pleased with its investment in technology and modernization represented by the Simba M6 C.

## Acknowledgements

Atlas Copco is grateful to the managements at both Ipueira and Medrado mines for their contributions to this article.

The slot drilling crew with their Simba.



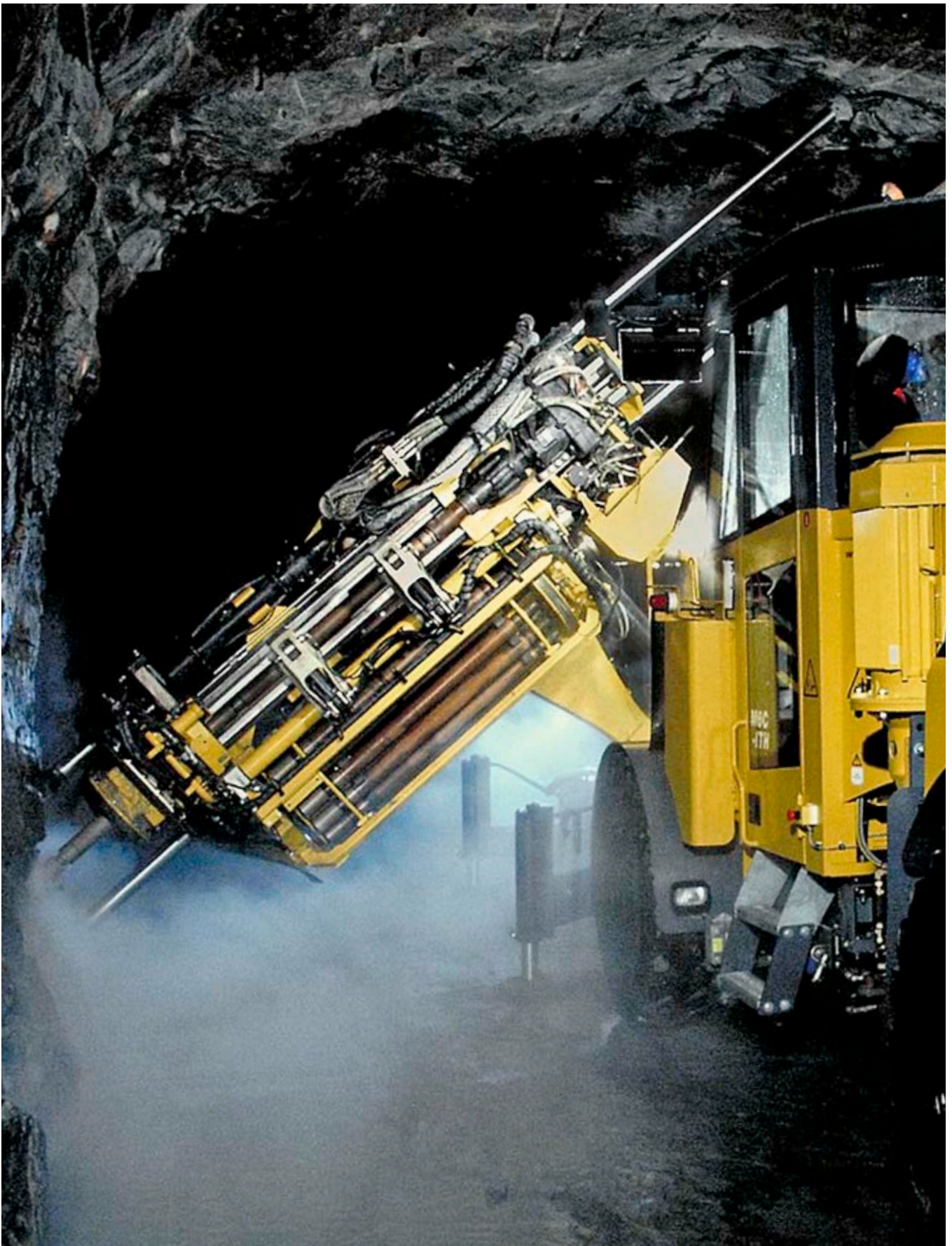

*Simba M6 C-ITH drilling downholes.*





# Getting the best for Peñoles

## Special operations

Industrias Peñoles' Proaño and Francisco I Madero mines are very special operations. Both underground mines, Proaño is a 450 year-old operation and the richest silver mine in the world, and FIM is just six years old and the largest zinc mine in Mexico. Located in the central state of Zacatecas, both mines are key users of Atlas Copco equipment, which includes Scooptram loaders and Minetrucks. Peñoles has decided to standardize its whole mining fleet on Atlas Copco equipment to obtain maximum benefit from the service and distribution centre in nearby Caleras.

## Mechanization pioneer

The official name of the Proaño mine comes from Captain Diego Fernandez de Proaño, who discovered the site and developed the first mining works on the hill that bears his name. The operation is also known as Fresnillo mine because of its proximity to Fresnillo city. It is run by the Compañía Fresnillo, SA de CV, which is 100% owned by Peñoles. With a history that can be traced as far back as the 1550s in Pre-Hispanic times, Proaño has gone through a number of phases, which have left an important mark on the mine. Its operations have been stopped due to economical and technical difficulties (1757 to 1830), as well as during the Mexican Revolution (1913 to 1919), and inevitably it has gone through several ownership as well as technological changes.

From employing basic manual tools in the early days, the mine now employs modern mechanized units, including some of the most sophisticated mining machinery available.

Embracing mechanization early on has been one of the factors that has helped Proaño cement its position as the world's largest and most profitable silver mine. They started mechanizing operations about 40 years ago, and during the



Setting up Simba 1254 for blast hole drilling.

last 30 years there has been a steady increase in production. Products are silver-lead concentrates and silver-zinc concentrates. In 2005, Proaño produced nearly 34 million troy ounces, or 1,055 t, of silver.

## Production expansion

During the mine's long history it has had to adapt to changes in the geology and work parameters. For instance, the mining method has had to be fundamentally changed several times, and each time the appropriate technology and equipment has had to be introduced. Atlas Copco has worked alongside the mine management for several years to adapt and innovate with primary equipment, service, training, inventory management and parts stock. The mine recently implemented a substantial production increase, going from 4,500 t/day to 7,000 t/day. To support this production expansion the company recently

increased its mining fleet with the purchase of three Rocket Boomer 281 development drill rigs additional to its four existing units, another Simba M4 C production drill rig additional to its existing three units, five Scooptram ST1020 loaders to complement its existing fleet of 17 units, and two Minetruck MT2000 trucks to increase its fleet to seven units. Atlas Copco has also started a service contract for the Simba rigs, which requires the presence of four technicians on site, and offers similar assistance for the loaders.

Currently, the Proaño mining fleet represents a mix of old and new Atlas Copco technology. Amongst the old units are Scooptram ST6C loaders, BBC 16 pneumatic rock drills, BMT 51 pusher leg rock drills and DIP & DOP pneumatic pumps. There are also Diamec U6, Diamec 262 and Diamec 252 exploration drill rigs, Boltec 235 bolting rigs, Rocket Boomer 104 drill rigs, Simba 1254 production drill rigs and Robbins



Map of Mexico showing Atlas Copco bases and mine locations.

raise borers. Furthermore, the mine uses Secoroc drill steel on development and production rigs.

Proaño was the first mining operation in Mexico to employ the Boltec rigs and the Rocket Boomer 281 rig with

telescopic advance, which represent completely new technology.

Likewise, Proaño owns two Diamec U6 APC deep hole drill rigs, the first mine in the Americas to use this type of machine.

During the first three months of 2006, the entire Atlas Copco mining fleet at Proaño achieved a physical availability of 89.5% against the objective of 90%.

Atlas Copco's commitment with Proaño goes beyond providing new equipment, and a few years ago it was decided to set up a distribution & service centre in Caleras, Zacatecas.

### Mining operations

The underground operations can be accessed either through two shafts, Central Shaft and San Luis Shaft, or by one of the mine's several ramps. The mine has seven levels and in Level 425 is the San Carlos orebody, which currently produces 67% of production.

Proaño carries out about 40,000 m of development drilling a year. To support this work, there are three different contracting companies: Mincamex, Jomargo and Mecaxa. All three companies own Atlas Copco equipment, mainly Rocket Boomer drill rigs and loaders.

The mining method is cut & fill using upwards and downwards drilling. However, the amount of drilling and the hole diameter have changed over the years.

Schematic of mine layout at Proaño showing sublevel stopping arrangement.

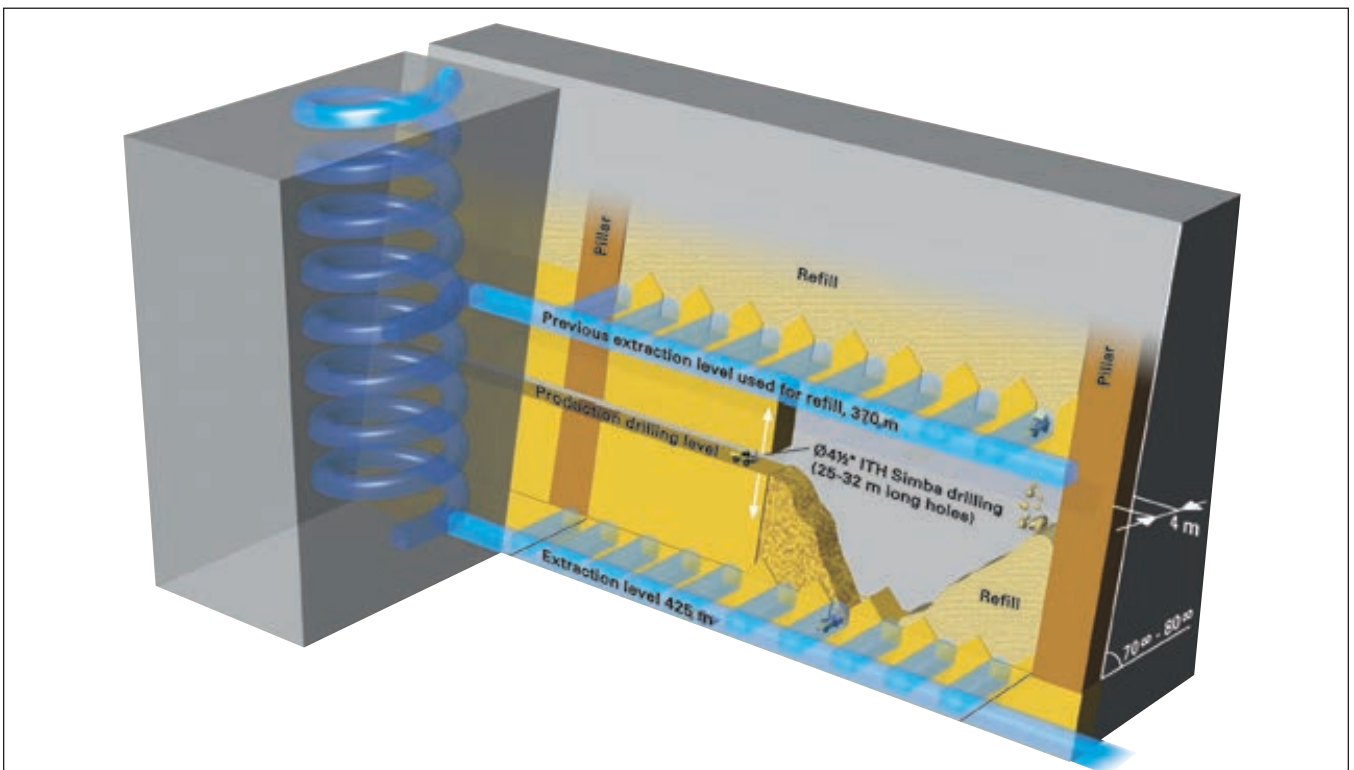



They went from drilling 20 m downwards and 10 m upwards to drilling 22 m downwards and upwards. Then changes in the orebody allowed use of long hole drilling employing Simba rigs with top hammers.

The base main level is serviced with electricity, water and air, from where the sublevels are supplied. Currently, the miners drill 25 to 32 m downwards and 25 to 32 m upwards, using a computerized Simba M4 C DTH rig from a single set up.

This method provides better safety, higher productivity and lower costs.

## Community & environment

The expansion of the Fresnillo city through the years means that Proaño's operations are now situated almost inside the city. The company has taken this fact as an opportunity to develop a good relationship with the community. In order to diminish the environmental impact of its operations, the company has invested in the installation of environmentally friendly equipment and machinery. Proaño has an ISO 14000 Environmental Management System certification and has also been awarded a Clean Industry Registration by the Mexican environmental authority.

Furthermore, the company has founded an ecological park, which is a sanctuary for several species of mammals, birds and reptiles. Nearby, there is also a tourist mine, and a mining museum to make the public familiar with the mining process and to preserve the history of the industry. In 2004 the company opened the Parque los Jales, a public area that includes lakes, paths and open areas for physical exercise and relaxation. This facility was built on the land formerly occupied by the tailings pond.

## New operation

Located about 15 km north of the city of Zacatecas, Francisco I. Madero (FIM) is one of Peñoles' newest mines, having started commercial production only in 2001. The mine's name comes from a former Mexican President, Francisco Ignacio Madero, killed during the Mexican Revolution. Although a polymetallic

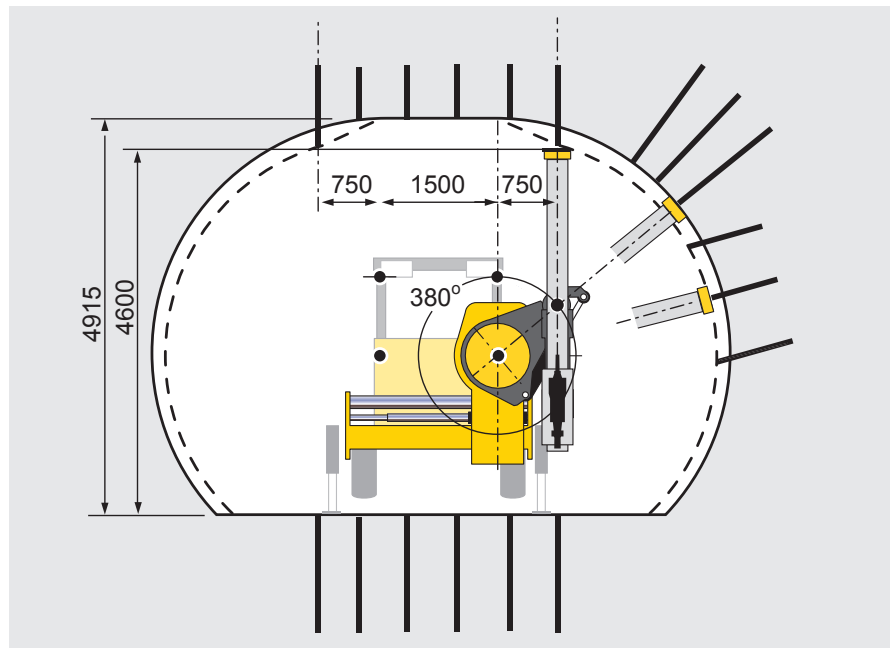

*Drilling possibilities offered by Simba M4 C.*

mine with reserves of gold, silver, copper, lead and zinc, FIM's main products are zinc concentrates and lead concentrates. At the end of 2005, the mine had reserves of 27.5 million t with an average zinc grade of 3.3% and 0.74% of lead.

With an investment of US\$125.8 million and a production capacity of 8,000 t/day, in 2005 FIM produced a total of 65,948 t of zinc concentrates and during the first semester of 2006, produced

31,572 t. The mine is equipped with a radio system for internal and external communication through a network of coaxial cables in the production levels, development areas and mining infrastructure. This system incorporates voice, data and video channels for communication between personnel, accident reduction, production control and location of vehicles and personnel.

Atlas Copco started working with the Peñoles' team in charge of the FIM

*Rocket Boomer L2 C drill rig with COP 1838 rock drills at Madero mine.*





Personal service at Proaño: left, Antonio Gonzales, mine captain, San Carlos area, with (far right) Rufino Molina, Atlas Copco drill master and Simba rig operators.

project in October, 1997 and has continued to provide technical support in the planning and development of the mine. The first order from the mine was for four Rocket Boomer L1 C and three Rocket Boomer L2 C drill rigs with single and twin booms respectively. These rigs, which have enclosed, air conditioned cabs, feature ABC Regular computerized drilling system with communication ports and protocols for PC, failure and anti jamming systems. FIM also ordered eleven Scooptram ST8C loaders with weighing system, real time communication system via leaky feeder to a control centre, and auto-diagnostic system with data port. The first machines arrived in 2000.

This initial fleet has subsequently been expanded to include: two Robbins raise-borers, a 61R and a 63RM; three SB 300 scalers; a Craelius Diamec U6 exploration rig; a Simba production drilling rig; and two Boltec 235 bolting rigs.

Furthermore, Atlas Copco Mexicana and FIM have an important maintenance contract, which has been running for six years. This is the largest such contract that Atlas Copco has in Mexico, and comprises a team of around 20 people including mechanics and supervisors, directly supported by their Ca-leras distribution & service centre.

According to the management at FIM, the Atlas Copco equipment has contributed to the rapid and safe advance in production at this mine.

## FIM mining operations

For development and production work, FIM employs several contracting companies, amongst which are Minera Castellana, which also carries out exploration work. Contractors Arconso and Paniagua Obras Mineras both conduct development work.

The latter has a specific contract to conduct at least 200 m/month of development work using an FIM Rocket Boomer L1 C rig equipped with COP 1838 drill and one of the Scooptram ST8C loaders. Around 235 m of development has been achieved in a month.

The Scooptram ST8C loader operator is very happy with the machine, which is the most modern equipment he has worked to date. He finds the controls easy, and had no problem learning to drive.

Because of the generally poor ground conditions, FIM employs cut & fill with pillars as its mining method. It has been the method of choice since operations started. It opens voids of 8 to 10 m, bounded by non-recoverable pillars of 6 m in a square section. It has a mineral recovery factor of 86% to 90%.

For production, horizontal and vertical drilling is used in a ratio of 30%:70%, but that will change by mid-2007 to 100% long hole drilling angled 75 degrees upwards. The roof is expected to be subjected to less damage, and less support should be needed. The risk of rock falls is also much lower. This is similar to methods used at

Proaño, so their experience will be most useful.

FIM uses a mixture of shotcreting and bolting, and recently acquired two Boltec 235 roof bolters with COP 1532 drills. Each machine regularly installs nine roof bolts per hour, or 56 per shift. Depending on the quality of the rock, up to 70 bolts/shift have been installed.

On average, about 2,400 bolts/month are installed. Tests at the mine prior to purchase of the Boltsecs revealed that the bolts were each taking 17 t loading.

Most of the mined material is unloaded by gravity directly to a crushing station.

The rest of the production is hauled in 40 t-capacity trucks in a closed circuit of horizontal haulage on the general haulage level, located at 210 m from surface.

A conveyor belt is installed in a 4 x 3 m ramp with an inclination of 21% and a length of 1,290 m from level 2022 to the surface.

For personnel access, mining equipment and general mining services, there is a 4.6 x 4 m ramp with an inclination of 13.5% and 1,790 m length between surface and the general haulage level.

## Maintenance

To deliver its maintenance contract, Atlas Copco has its own facilities at the mine, backed up by the distribution and service centre in Calera. The contract includes preventive and corrective maintenance, and follows a programme already prepared for all the Atlas Copco fl et.

The service contract has a specific programme every week depending on the machines to be serviced. About 50% of the machines have been working for between 18,000 and 20,000 hours without any rebuild, which is a good reference for the quality of the equipment. The contract also involves operator training.

## Acknowledgements

*Atlas Copco is grateful to the mine managements at Proaño and Madero and directors of Peñoles Group for their inputs to this article and for permission to publish.*



# Keeping a low profile at Panasqueira

## One hundred years of history

Primary Metals Inc (PMI) is owner of the Panasqueira mine in Portugal, in production for over 100 years, and still the largest single source of tungsten in the world. Thin seams in low headroom make the mining tricky, but Atlas Copco Portugal was able to come up with the perfect package of low headroom mining equipment, including its increasingly popular Scooptram ST600LP underground loader. PMI also chose Atlas Copco Finance for funding the fleet purchase, agreeing a simple supplier-credit arrangement tailored to match the demands of the operation. As a result, overall mine productivity has increased by 25%, and daily production records are being broken. Above all, the partnership between equipment supplier and end-user is proving to be progressive and profitable!



*Panasqueira mine is located at Barroca Grande in Portugal.*

## Introduction

The Panasqueira mine is located at Barroca Grande in a mountainous region of Portugal, 300 km northeast of the capital city of Lisbon, and 200 km southeast of the port city of Porto.

The mining concession lies in moderately rugged, pine and eucalyptus covered hills and valleys, with elevations ranging from 350 m above sea level in the southeast to a peak of 1,083 m above sea level in the northwestern corner.

The concession area is an irregular shape trending northwest-southeast, and is approximately 7.5 km-long. It is 1.5 km-wide at the southeastern end, and 5.0 km-wide at the northwestern end, where the mine workings and mill facilities are located. The geology of the region is characterized by stacked quartz veins that lead into mineralized wolfram-bearing schist. The mineralized zone has dimensions of approximately 2,500 m

in length, varying in width from 400 m to 2,200 m, and continues to at least 500 m in depth.

## Production levels

Access to the mine's main levels is by a 2.5 m x 2.8 m decline from surface, with a gradient of 14%. The main levels consist of a series of parallel drives that are spaced 100 m apart, and which provide access to the ore passes for rail transport, and connect with ramps for movement of drilling and loading equipment.

There are seven veins between the 2nd and 3rd Levels, which are 90 m apart. The veins are almost flat, but occasionally split or join together. They pinch and swell, and are usually between 10 and 70 cm-thick, and can plunge locally

as much as 3-4 m over a very short distance.

Blocks of ore are laid out initially in 100 m x 80 m sections by driving 5 m-wide tunnels, 2.2 m-high. Similar tunnels are then set off at approximately 90 degrees to create roughly 11 m by 11 m pillars, which are ultimately reduced by slyping to 3 m by 3 m, providing an extraction rate of 84%.

Blasted ore is loaded from the stopes by a fleet of six low-profile Atlas Copco Scooptram ST600LP loaders, tipping into 1.8 m-diameter bored raises connecting to the main level boxes.

Rail haulage with trolley locomotives is used to transport the ore to the shaft on Level 3, and to the 900 t-capacity main orepass on Level 2 that provides storage for the 190 t/h jaw crusher located at the 530 m-level.



Scooptram ST600LP under maintenance.

Crushed ore discharges onto the 1,203 m-long, 17% inclined Santa Barbara conveyor belt that connects with a 3,000 t-capacity coarse ore bin located beneath the mine office.

Primary mine ventilation is provided naturally by several ventilation raises. Airflow is controlled by curtains in main areas and assisted by axial flow fans where needed, particularly in the stopes.

Compressed air is needed for the charging of the blast holes with ANFO,

and a new compressor unit was installed underground in 2002.

The mine is supplied by 3.0 kV electrical power, which is reduced to 380 V for distribution to equipment.

### Mining method

The stoping process begins when spiral ramps are driven up to access the mineralized veins, and the orebody is opened in four directions and blocked out.

East-west oriented tunnels are called Drives, and those trending north-south are called Panels. Drives and Panels are driven 5 m-wide and, where they intersect, 1.8 m-diameter raises are bored between haulage levels to act as ore-passes for all of the stopes. Chutes are installed in the bottoms of the orepasses to facilitate the loading of trains.

The height of the stopes is nominally 2.1 m, but can increase to 2.3 m in areas where ore bearing veins are more variable in their dip, strike or thickness.

Precise survey control is maintained, so that all final pillars are aligned vertically. Experience has shown that the stopes will usually begin to collapse about 4 or 5 months after extraction, which gives plenty of time to glean any remaining fines from the floor.

Stope drilling is carried out by new generation Atlas Copco Rocket Boomer S1 L low profile electric hydraulic single boom jumbos. Rounds are drilled 2.2 m-deep, utilizing a Vee-cut, and 41 and 43 mm-diameter drill bits. Drilling is carried out on two shifts, with about 28 holes required per 5 m-wide round. ANFO is loaded pneumatically into

Schematic of stope layout.

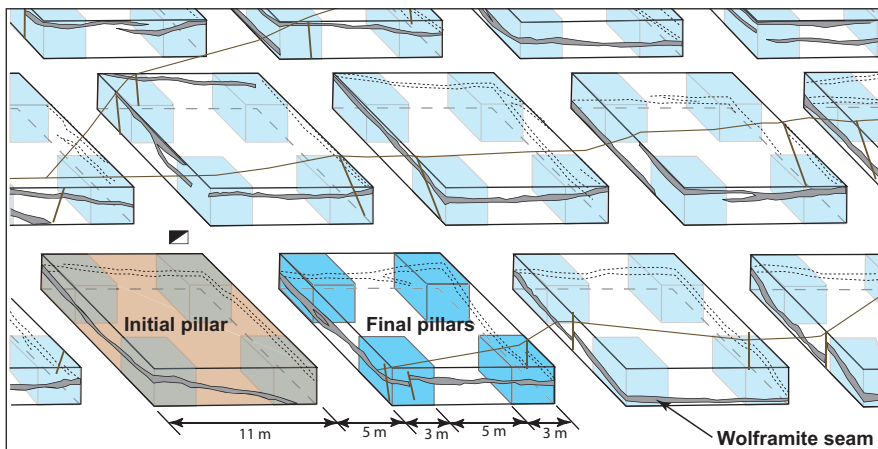



*Boomer S1 L drill rig in operation.*

the blast holes, and electric delay detonators along with small primers are used for blasting. Blasting takes place around midnight, and the mine then ventilates throughout the night.

Each blasted face produces about 60–65 t of rock, and each rig can drill up to 10 faces/shift, depending upon the availability of working places.

After the blast, the muck pile is washed down, and the back is scaled. Ore is loaded and hauled by the Scooptrams from the headings to the orepasses.

Once the limits of the stopes are established, then the final extraction takes place with 3 m x 3 m pillars created from the perimeter retreating to the access ramp.

## Drilling performance

The mine drill rig fleet comprises three Atlas Copco Boomer H126 L drill rigs mounted with COP 1238ME rock drills; five Atlas Copco Rocket Boomer S1 L low-profile drill rigs mounted with COP 1838ME rock drills; and three older drill rigs retrofitted with COP 1238LP rock drills.

All drilling uses ballistic button bits, of which the preferred 43 mm-diameter Atlas Copco Secoroc SR35 bits used by the COP 1838 rock drills are returning 370 m/bit, while the 41 mm-diameter bits are returning 450 m/bit. In such abrasive rock, bit wear has to be closely monitored to avoid an escalation in costs. Likewise, regrinding has to be to a high standard.

The recent addition of Rocket Boomer S1 L models to the fleet has resulted in a 50% increase in output/drill rig, while less waste rock is generated due to the lower profile required for safe operation. This drill rig will operate in a seam height as low as 1.3 m and is equipped with four-wheel drive for maximum tractability. The COP 1838 rock drill has double reflex dampening for high-speed

*Core drilling in the levels.*





Scooptram ST600LP in low headroom stope.

drilling and excellent drill steel economy.

Drilling is performed primarily on day and afternoon shifts on around 50 faces. These are maintained in close proximity to one another, to avoid long moves for the drill rigs.

## Scooptram ST600LP

Each Scooptram ST600LP cleans 4-6 headings/shift on a maximum 200 m

round trip to tip, consuming 12 lit/h of diesel.

The ST600LP is an extremely robust LHD designed specifically for demanding low seam applications where the back heights are as low as 1.6 m. It has an operating weight of 17.3 t and a tramming capacity of 6 t, equipped with a 3.1 cu m bucket. It is 8.625 m-long, 1.895 m-wide and 1.56 m from floor to top of canopy. It is powered by a robust 6-cylinder diesel engine, providing a

mechanical breakout force of 8.7 t and hydraulic breakout force of 9.3 t. For visibility on the far side of the machine, video cameras point forward and aft, reporting to a screen in the driver's cab. The model has gained a well-deserved reputation in the platinum, palladium and chrome mines of South Africa, where gradients are steep and rock is highly abrasive. The ST600LP is now proving itself in similar rigorous conditions at Panasqueira, where the roof is not well defined, and there are frequent seam irregularities.

The mine currently operates at a rate of 65,000 t/m with a recovered grade of 0.2% WO<sub>3</sub>, which should produce about 112 t of high grade and 20 t of low-grade concentrate. Some 150 people are employed underground on two shifts, five days per week.

## Acknowledgements

*Atlas Copco is grateful to the directors and management at Panasqueira for their kind assistance in the production of this article, and for providing access to the mine statistics.*

Main access ramp to level 2 at Panasqueira mine.







A series of horizontal dotted lines for taking notes.

# Want peace of mind? Visit our Master Class Support!



[www.atlascopco.com](http://www.atlascopco.com)

By launching our One-Stop-Shop, we are committed to make life simple and business more profitable for you. Within our concept you will find genuine parts as well as technical competence regarding your equipment. You will become familiar with new, innovative service and logistic solutions to enhance availability and productivity.

Interested in our Master Class Support? You are most welcome to get more information at our local customer centres.

**Committed to your superior productivity.**

*Atlas Copco*

# When safety comes first



Add a solid-body hydraulic breaker to a proven folding boom on the world's most tested underground carrier, and you have the Scaletec MC – a scaling rig for tunnelling and mining applications. Scaletec MC will give you higher productivity, less accidents, and a giant step along the route towards full mechanisation.

**Committed to your superior productivity.**

**Atlas Copco Rock Drills AB**

**[www.atlascopco.com](http://www.atlascopco.com)**

**Atlas Copco**